

werzalit®

since 1923.

RESERVE THE BEST TABLE!



**IDEATION,
MANUFACTURING
AND COMMERCIALISATION**

-
TABLE TOPS
TABLE BASES
CHAIRS



WERZALIT® 100 years of innovation!

Dear customers!

With the celebration of the **100th anniversary** of our group, 2023 is a memorable milestone in the history of **WERZALIT**.

During all these years in which you have placed **your trust** in us, we have never been so committed to **reserving you the best table** whether that be in **France**, in **Europe** or **around the world!**

And, indeed, it is around our **WERZALIT table** that is resolutely multi-functional, inventive, technological and connected, that we invite you once again, where we further cement our position as the best place around which to enjoy moments together.

For you, in this year 2023, we wanted to place service even more at the **centre of our offer:**

- We respond to **modern communication practices**, with the integrated Ipan Ipan solution allowing the charging of smartphones by wireless induction or by discreet USB connection.
- We expand our range of self-stabilizing bases by offering you a **sensational table base innovation** with **4 independent legs** working on all uneven surfaces: the **Contact X4 Crescendo**. In addition to its folding system, with its adjustable height it can also accommodate people with reduced mobility as well as be transformed from a sitting into a standing table.
- We now offer you **Top 30 Decors**, but also a **Top 15 Table Bases** and a **Top 10 Chairs**, all accompanied by a record delivery time: 5 working days.
- We are setting your establishments to music with the creation of **JAZZ**, our **new interior** range, sparkling, colourful, elegant, dedicated to interior design.
- We are growing our BISTRO range, the collection synonymous with Werzalit's reputation on all continents, thanks to 2 new types of brass: smooth and brushed, but also 6 optional surface structures for an unprecedented **sensory experience**.
- We are once again acting as a trendsetter on the market with **5 new audacious decors**.

Whether it is moulded laminate, wood-look moulded laminate, real wood or HPL, the Werzalit table is intended for all places and **all times of sharing!**

This year again, dear customers, we are honoured to invite you to our table!

Elise Ratajczyk
General Manager

Lionel Labadie
Commercial Director



SUMMARY

New for 2023 :

- 06** - Decors
- 07** - BISTRO Circles and frames
- 08** - Textured table tops
- 09** - Contact ^{X4} Crescendo
- 10** - New JAZZ collection

- 14** Cambium & Massif
- 18** Innovation Ipan Ipan
- 24** Top 30
- 26** The Unmissables
- 28** Bistro
- 32** POD (Product On Demand)

Personalised table tops

- 34** - Easy Perso
- 35** - Perso

- 36** Carino
- 42** Table bases
- 66** Chairs & Arm Chairs
- 76** Tables & Kits
- 79** Request a Quote



THE ORIGINAL



HYGIENIC

Our table tops have been subjected to numerous **laboratory tests**, the results have shown **excellent resistance** to bacteria. More than 99.7% of bacteria are eliminated after a simple cleaning with water and / or soapy water, which allows easy **maintenance and safe use**.



MADE IN FRANCE

Werzalit SAS is **ISO 9001 certified**, a testament to our commitment to quality and customer service.



The quality of French production recognized worldwide, linked to **our know-how**, has enabled Werzalit to offer quality products on the market since 1923. The thoroughness and quality of the work of our employees at our production site located in Rochefort (on the French west coast) allow us to produce and deliver throughout **Europe** and the whole world, at any **time of the year**.



ENVIRONMENTALLY FRIENDLY

The manufacture of our products as well as the **choice of materials** from which they are made are always done with the greatest respect for nature. Our production is made from **100% recycled wood**. We optimise waste from the wood industry.



INDUSTRIAL

Our capacity as an industrialist and as main player in the market since 1923 allows us to display recognized production **quality as well as exemplary local service**. The WERZALIT CLASSIC moulded laminate tops are guaranteed for **5 years**, waterproof, and **UV resistant**. Ideal for indoor and outdoor use.

SERVICES

TOP 30 DECORS TOP 15 TABLE BASES TOP 10 CHAIRS

New for 2023, our selection of **decors, table bases and chairs** have been fully adapted to your needs and ordering habits. The availability of products is of the highest priority to Werzalit so that they will be delivered in the optimal way. All the product references forming part of the **TOPS** below are kept in stock in order to best anticipate your requirements and those of the end use customer **throughout the year**.

THE TOP 30 DECORS

These are available from our Rochefort site within **5 working days**. There are a total of 30 decors and 5 Sizes, i.e. 180 different options to allow you to create warm and varied atmospheres.

THE TOP 15 TABLE BASES

These are available from our Rochefort site within **5 working days**. These are 15 references of different styles which constitute many variations to perfect the atmosphere of each establishment.

TOP 10 CHAIRS

These are available from our Rochefort site within **5 working days**. These are 10 essential references that single out the character of each restaurant, café or bar.

BISTRO

As the first manufacturer to have brought you the tradition of framed outdoor table tops in Ø 60, Ø 70, Werzalit is committed to quality, in order to offer you framed outdoor table tops 55 x 55, 60 x 60 and 70 x 70.

POD THE CREATION

Werzalit, **the French manufacturer**, is always one step ahead with innovative creative lines and constantly **updated on-demand products**. In addition to the already existing library and as a true fashion designer, several themed collections will be offered to you during the year.

INSERTS

By **4** or by **8**

The position of inserts greatly facilitates the assembly of tables and saves considerable time during installation.

PACKAGING ADAPTED TO YOUR NEEDS

- Per carton containing 2 products
- Per carton containing 1 product
- By industrial pallet



Moulded laminate table tops are **guaranteed for 5 year**.



Compatible table top **Ipan Ipan** (wireless charging solutions) **> Technology to discover p.18 - 19**



99,7% of bacteria removed after cleaning table tops with soapy water.

New for 2023

5 new decors are entering our collection The Unmissables

Trendy and audacious are the hallmarks of these designs. Try them!



5 decors exit our range in 2023

They will however be available until depletion of paper stocks.

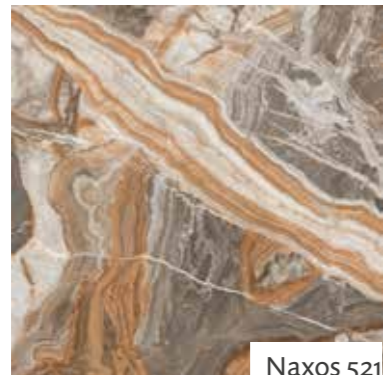

Naxos 521



Sylva 522



Azrak 523



Taiga 524



Thor 525



Bounty 010



Californie 128

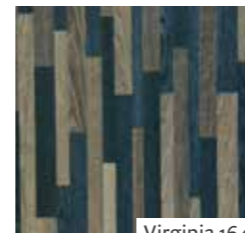

Virginia 164



Alabama 219



Idaho 246



A new proposal for circles and frames



DECOR TRIANA 513
CIRCLED WITH SMOOTH BRASS



Decor Triana 513
with brushed brass frame

Our collection is enriched with **2 new elegant solutions** that reinvent the Bistro style: **Smooth and brushed brass**. These enhance the decors to bring a elegant and contemporary style, both for interior and exterior projects.

New 2023

A new solution for textured table tops

6 exclusive options from our BISTRO collection for a unique tactile experience.

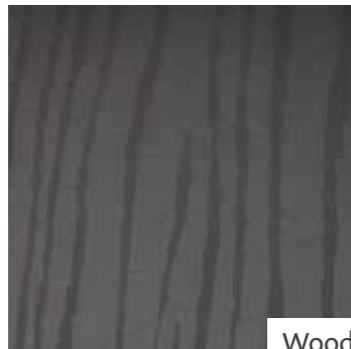

Wood

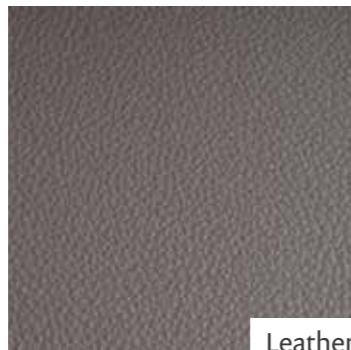

Leather

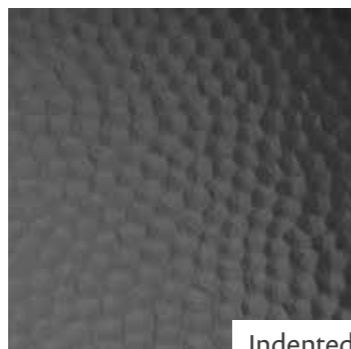

Indented



Gloss



Slate



Mineral



With CONTACT^{X4} CRESCENDO your table will never have been so stable!

With **Contact^{X4} CRESCENDO** your table will never have been so stable!
Contact^{X4} CRESCENDO is a real revolution in the field of self-stabilization !



Adaptable in height from
from 72 to 108 cm



Adaptable to
people with
reduced mobility



Adaptable to
the most extreme
unevenness



Adjusts in height
from 72 to 108 cm



TOP DECOR
MONTPELLIER 214
TABLE BASE
CONTACT^{X4} CRESCENDO



Scan this QR Code
and discover how
the Contact^{X4} Crescendo
works



4 ADJUSTABLE
INDEPENDANT FEET

4 ADJUSTABLE
INDEPENDANT FEET

ADJUSTS IN HEIGHT FROM 72 TO 108 cm, this base can be adjusted to the height that you wish with one simple quick movement. By simply operating the handle below the top, it allows **people with reduced mobility** to find optimal comfort at the table. On the other hand, it can, just as easily, transform a classic table into a bar height table, and vice versa, adapting to changes in the atmosphere of your establishments.

Last but not least, **Contact^{X4} CRESCENDO** has 4 independent feet! This technical prowess makes it a unique table base that adapts to the most **extreme unevenness**, even when each of the legs are at a different level from one another!



New for 2023

JAZZ, our new INTERIOR range

With **JAZZ**, set your interior design projects to music and **create an incomparable atmosphere!**

Sparkling, colourful, elegant, rhythmic and abundant, our **JAZZ** collection, made up of numerous proposals of **table tops, table bases and chairs**, combines different materials and shapes to create an atmosphere that can be anything from exuberant to subtle, according to your inspiration. **Character and originality** are the key words.

Some models presented are outside of our standard range. Available in other colours and finishes.

JAZZ CHAIRS

BEBOP

- Black 084596
- Orange 084616
- Grey 084615
- Blue 084617
- Green 084618



BEBOP CHAIR
INTERIOR AND EXTERIOR

W	44 cm
D	52 cm
H	80 cm
WT	3 kg



CALYPSO

Black 084598



CALYPSO CHAIR
INTERIOR AND EXTERIOR

W	50 cm
D	75 cm
H	95 cm
WT	4 kg



HARMONY

- Black 084599
- Beige 084701
- White 084703
- Green 084702



HARMONY CHAIR
INTERIOR AND EXTERIOR

W	49 cm
D	46 cm
H	81 cm
WT	4 kg



TEMPO

- Black 084706
- White 084706
- Grey 084705
- Beige 084704
- Anthracite 084597



TEMPO CHAIR
INTERIOR
WITH CUSHION

W	51,2 cm
D	51 cm
H	77,8 cm
WT	3,75 kg



GROOVE



The first eco-responsible stool made in France from waste cereals from beer brewing. Removable and customizable. Assembles in minutes. Black powder coated steel structure.

GROOVE STOOL
INTERIOR

W	35 cm	35 cm
D	35 cm	35 cm
H	75 cm	65 cm
WT	8 kg	7 kg



JAZZ TABLE BASES

You will find the entire collection of models in the section 'Table Bases' starting on p 43

BEATS



MAESTRO



OCTAVE



AVAILABLE IN BLACK
OTHER COLOURS ON DEMAND
TABLE BASE SOLD ALONE
TABLE TOP NOT AVAILABLE

RIFF



	REFERENCE	WIDTH	LENGTH	HEIGHT	WEIGHT	MAX SIZE
BEATS	o84609	70 cm	70 cm	72,5 cm	14 kg	Ø 100; Ø 120 ; 80x80; 90x90 cm
MAESTRO	o84608		Ø 50 cm	73 cm	19,5 kg	Ø 80; Ø 100 ; 70x70; 80x80 cm
OCTAVE	Black o84604	65 cm	65 cm	73 cm	10,5 kg	Ø 80; Ø 100 ; 70x70; 80x80 cm
RIFF	EXT o84747 INT o84607	65 cm	65 cm	73 cm	5,5 kg	Ø 70; Ø 80 ; 70x70 ; 80x80 ; 70x60 cm

JAZZ TABLE TOPS

CYMBAL



TABLE BASE OCTAVE IN GOLD



Detail

FUSION



JAZZY



CHEVRONS DECOR

AQUARELLE DECOR



	FORM	CIRCLE / FRAMED	IPAN IPAN	SIZE	THICKNESS	EDGE SHAPE	WEIGHT
FUSION	○			Ø 60 cm	25 mm	multicolour	6 kg
				Ø 80 cm	25 mm		10 kg
CYMBAL	□			80 x 80 cm	25 mm		13 kg
JAZZY	◻			70 x 60 cm	25 mm		7 kg



CAMBIUM

INTERIOR

High quality collection of table tops.

Elegant and aesthetic, it gives your establishment a intimate and warm atmosphere.

- Laminated surface 7/10th
- Water-repellent chipboard core
- Steamed paper underside for 29 to 39 mm tops
- White 7/10th stratified underside for 21 mm tops

3 thicknesses

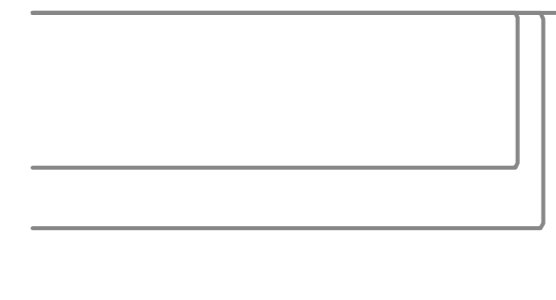

Available in :
21 mm
29 mm
39 mm thick

MASSIF

INTERIOR

The novelty of Werzalit for your interiors.

The table tops in real solid oak give your establishment a friendly air, while keeping a sleek design.

- Oak aged two years



22 mm thick

Cambium interior

CLASSIC

This collection of interior furniture has been designed with sobriety by Werzalit. The choice of materials and colours is made to play the card of design and elegance. A collection which gives a singular character to bars, restaurants and hotels.

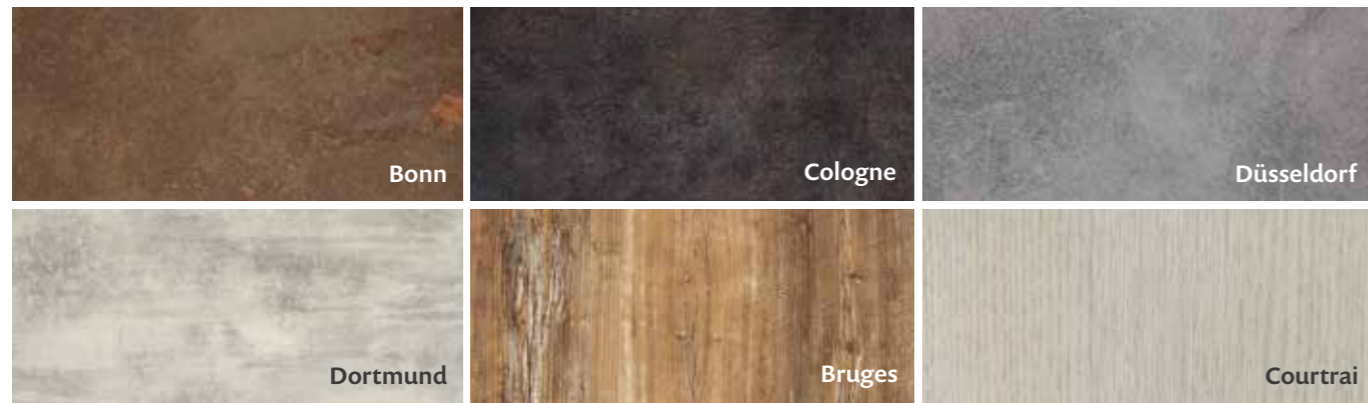

○ ROUND	□ SQUARE		□ RECTANGLE	
Ø 60	60X60	70X70	70X60	120X70
.



Cambium interior

SYNCHRO

The realism of the wood grain ribs and Halifax oak knots are eye-catching, while creating the most authentic decor in line with the furniture trend in appearance of solid wood. It works well with a combination metal, glass or stone. The structure coincides exactly with the grain of the decor and adds a tactile effect close to reality.



○ ROUND	□ SQUARE	□ RECTANGLE	
Ø 60	65X65	70X60	120X70
.	.	.	.

Interior

MASSIF

The new collection of solid wood interior table tops from Werzalit. Enjoy the durability and elegance of real solid wood in your business or restaurant. Through these table tops you will find the attraction and the inimitable authenticity of the solid oak that your interior needs.



○ ROUND			□ SQUARE		□ RECTANGLE	
Ø 60	Ø 70	Ø 115	60X60	70X70	70X60	115X70
.



WERZALIT'S CONNECTED TABLE TOP

IPANIPAN

WERZALIT & IPAN IPAN
OFFER YOU THE BEST
WIRELESS CHARGING
SOLUTIONS AT THE TABLE.

Completely integrated into the table top and invisible on the surface, **the induction charging zone blends into the decor with a simple marking on the table top.** The furniture thus retains its integrity for a smooth touch.



2 USB ports



No mains connection



1 wireless charging zone



Locked batteries



4 battery charger



8 days of autonomy



Exterior & interior



Liquid resistant



Ready to use



50%

of consumers are willing to stay longer (and consume more) if they can charge their phone.

64%

of consumers want to charge their phone or tablet in the establishment they are.



INDUCTION CHARGING AREA INTEGRATED INTO THE TABLE TOPS



Scan this QRCode and discover THE INSTALLATION OF THE BATTERY PACK

A wireless charging solution that means no need for cables.





TABLE TOPS

Werzalit has designed for you a collection where styles and variety come together. Qualitative and hygienic, our table tops will allow you to give to your rooms and terraces an authentic charm and a unique look.



New for 2023 JAZZ

Interior table tops laminated or veneered fixed with specific inserts for the JAZZ table base collection.

P. 13



CAMBIUM

Interior wood-look laminate tops.
Fixing by wood screws or inserts.

P. 14 - 16



MASSIF

Solid oak tops.
Fixing by wood screws.

P. 14 - 17



TOP 30 & THE UNMISSABLES

Moulded laminate Table tops.
Fixed by wood screws or inserts.

P. 24 - 27



BISTRO

Moulded laminate table tops with metal circles and frames. Frames available: brass, stainless steel, copper.
Fixing by wood screws or inserts.

P. 28 - 31



POD

Selection of creative and original moulded laminate tops.
Fixing by wood screws or inserts.

P. 32 - 33



EASY PERSO

Custom moulded laminate tops in a pre-defined colour and finish framework.
Fixing by wood screws or inserts.

P. 34



PERSO

Moulded laminate tops fully personalized and adapted to your needs.
Fixing by wooden screws or inserts.

P. 35



CARINO

Compact HPL tops.
Fixing by grooves and bolts.

P. 36 - 39



MOULDED LAMINATE

Top 30

**YOUR ORDERS
DELIVERED IN
RECORD TIME**



Scan this QR Code and discover the whole from the Top 30 range

Replacing our former Top 20, these are now 30 decors that make up our new Top 30. The Top 30 decors are kept in permanent stock in the 5 formats specified below, with other formats available on request according to a deadline which will be provided upon request. In line with your needs and ordering habits, these Top 30 decors have been designed by Werzalit to offer you great delivery flexibility and the provision of quality products as quickly as possible.

> Place your Top 30 Decor orders with our Sales Department and be delivered in record time with an order leaving within 5 working days.



○ ROUND		□ SQUARE			□ RECTANGLE		OTHER SIZES
Ø 60	Ø 70	Ø 80	60x60	70x70	80x80	110x70	120x80
shipping within 5 working days		on demand	shipping within 5 working days			on demand	

THE DECORS





MOULDED LAMINATE

The Unmissables

MAKE THE ORIGINAL CHOICE

In addition to our Top 30, our 'THE UNMISSABLES' are available on request. They are constantly evolving to stay as close as possible to the aesthetic trends of the moment. Our 5 new 2022 models, as well as our 5 bold 2023 models; Thor, Taïga, Sylva, Azrak and Naxos, are among them. Choose from our inspired selection!

> All formats and decors are on request.



Scan this QR Code and discover the whole from the Unmissable

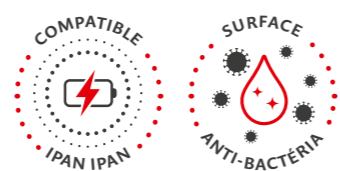

Chadna 510

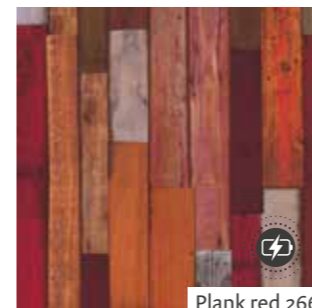

Plank red 266



Shaniko 509

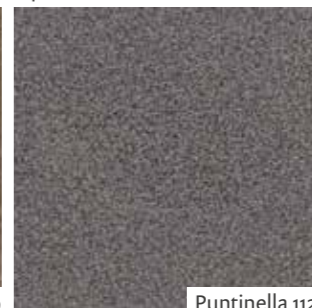

Puntinella 112



Factory 083

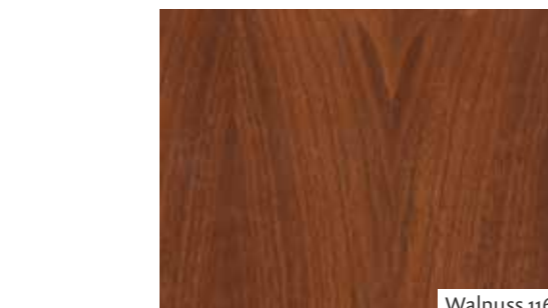

Walnuss 116



Tempera silver 046



Lagos 504



Oak milled 170

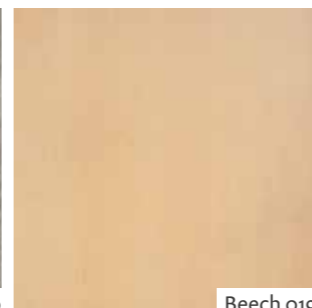

Beech 019



Kbana taupe 211



Sicilian marble 144



Plank blue 264

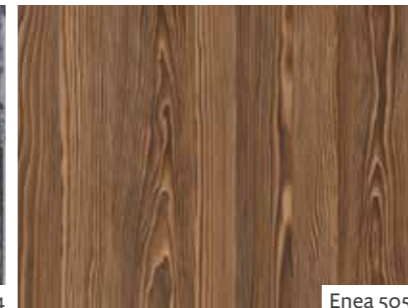

Enea 505

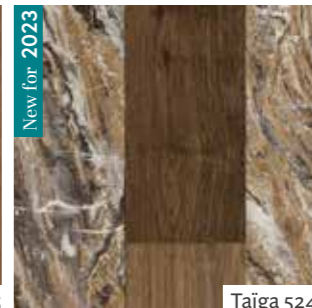

Taïga 524



Verona 506

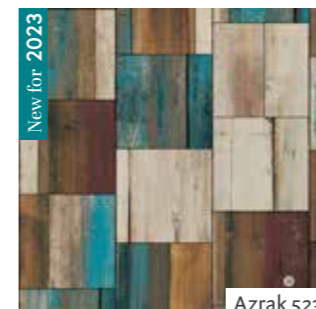

Azzrak 523

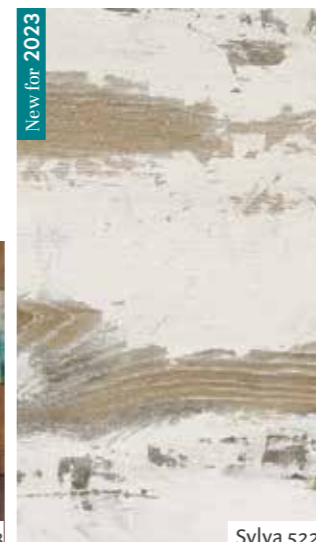

Sylva 522



Thor 525



Naxos 521

THE DECORS



The Bistro finish is available for:

- All decors from the TOP 30 range
- All the decors in the The Unmissable range
- All exclusive Bistro decors
- All the creations of the POD range
- All your Easy Perso and Perso creation projects
- Square table tops from the Massive range (brass and copper only)
- Finishing metals: smooth, moulded, brushed brass, stainless steel and copper

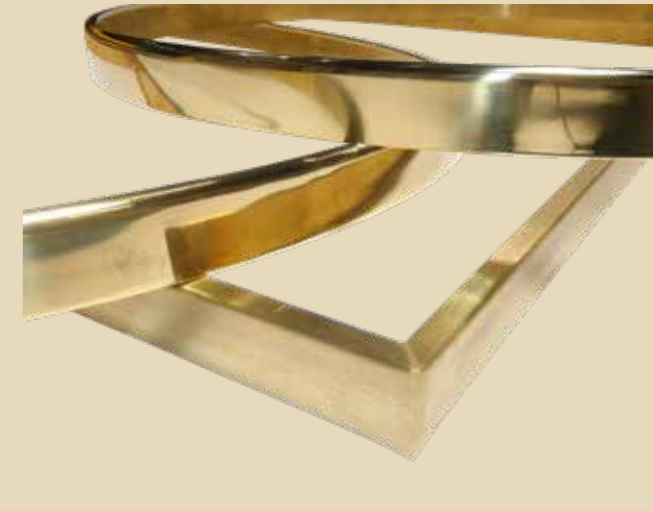

It is with the knowledge and know-how of our technicians, that we have been able to develop a mastery of the framing technique for exterior decks which gives the product an elegant and refined aesthetic. This quality is the result of qualitative and rigorous manufacturing know-how.

Werzalit is the first to offer you **an exterior quality framed solution.**



MARQUINA MARBLE
STAINLESS STEEL RING
Ø 60



SIENNA MARBLE
WITH BRASS CIRCLE
Ø 70
BISTRO BASE



SICILIAN MARBLE
FRAMED BRASS
55X55



ALMERIA MARBLE
COPPER FRAMED
60X60

Bistro



DISCOVER THE ELEGANCE AND AUTHENTICITY OF A TRUE PARISIAN BISTRO

With this collection, create warm and traditional atmospheres for your establishment. Our Bistro finish is available on the top 20/50 selection, in POD as well as for Perso and Easy perso. It is also compatible with our Ipan Ipan charging technology. Don't wait any longer to create a unique atmosphere. For the maintenance of your circles or frames, we recommend the use of a cleaning product for metals to maintain and enhance the aesthetics of the materials used.

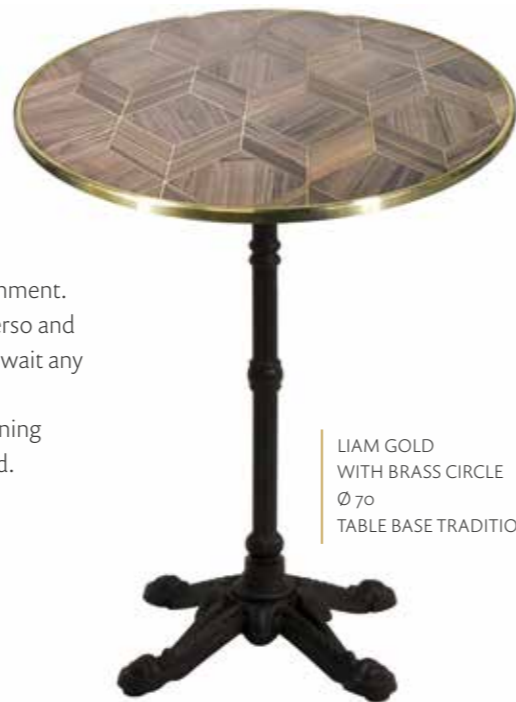

LIAM GOLD
WITH BRASS CIRCLE
Ø 70
TABLE BASE TRADITION 4

○ ROUND		□ SQUARE		
Ø 60	Ø 70	55X55	60X60	70X70
.

 As our metal circles and frames are made from real brass, copper and stainless steel, they can react to their surrounding environment. As result, there can be oxidation that takes place. We recommend that you maintain the metal circles and frames by cleaning regularly and using a product adapted to the specific material.

Bistro

Exclusive Range

NEW COLLECTION
OF REFINED AND
AUTHENTIC DESIGNS

MODELS BELOW: TRIANA 513

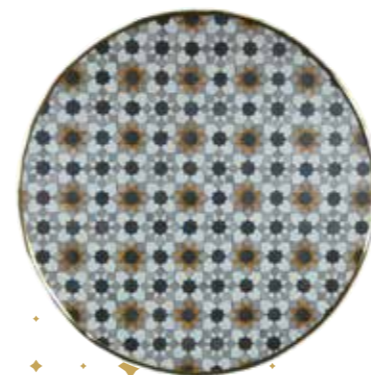

Fez white 516



Fez blue 514

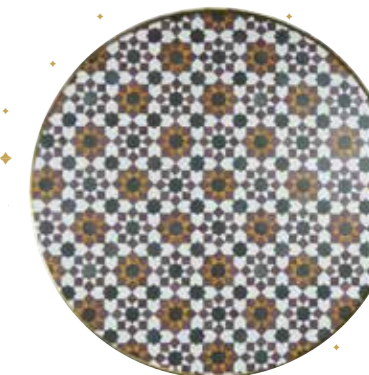

Fez red 515



Kapea 511



Kalima red 518



Kalima blue 517



Infinity brown 507



Liam 519



Liam gold 512



LIAM 519
WITH BRASS CIRCLE
MOULDED
TRADITION 3 BASE

For even more
originality and creativity,
mix the colours on your terrace!

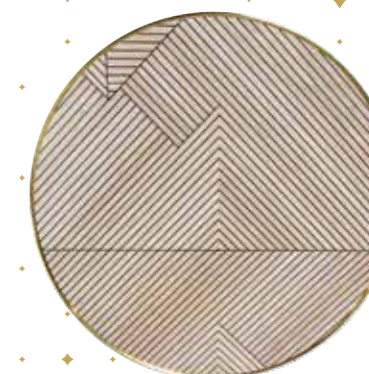

Triana 513



For many years, we have been offering products with character. Your interest in our "Bistro" range, with its rimmed and framed finishes, has continued to grow. **"the Exclusive range"**, which offers a wide choice of decors only in **circled or framed finish**.



POD

PRODUCT ON DEMAND

"Product On Demand" is an offer of table tops, creative and original, constantly renewed by us. The wide variety of decors available allow you to stand out and give a real personality to your establishment.

> Scan this QRCode and discover the whole POD range.



Consult us for the available formats.

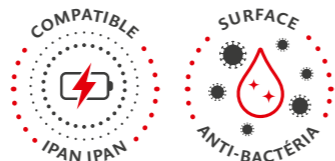

THE DECORS

selection presented in the brochure

1. Piment
2. Kingdom
3. Car Wash
4. Hawaï
5. Deck
6. Sino Black and red
7. Cap Oléron
8. Teak Wood
9. Poséïdon
10. Blue sky Macaron
11. Régate
12. Mozaïk
13. Cabaret zebra
14. Cap Horn
15. César

THE DECORS

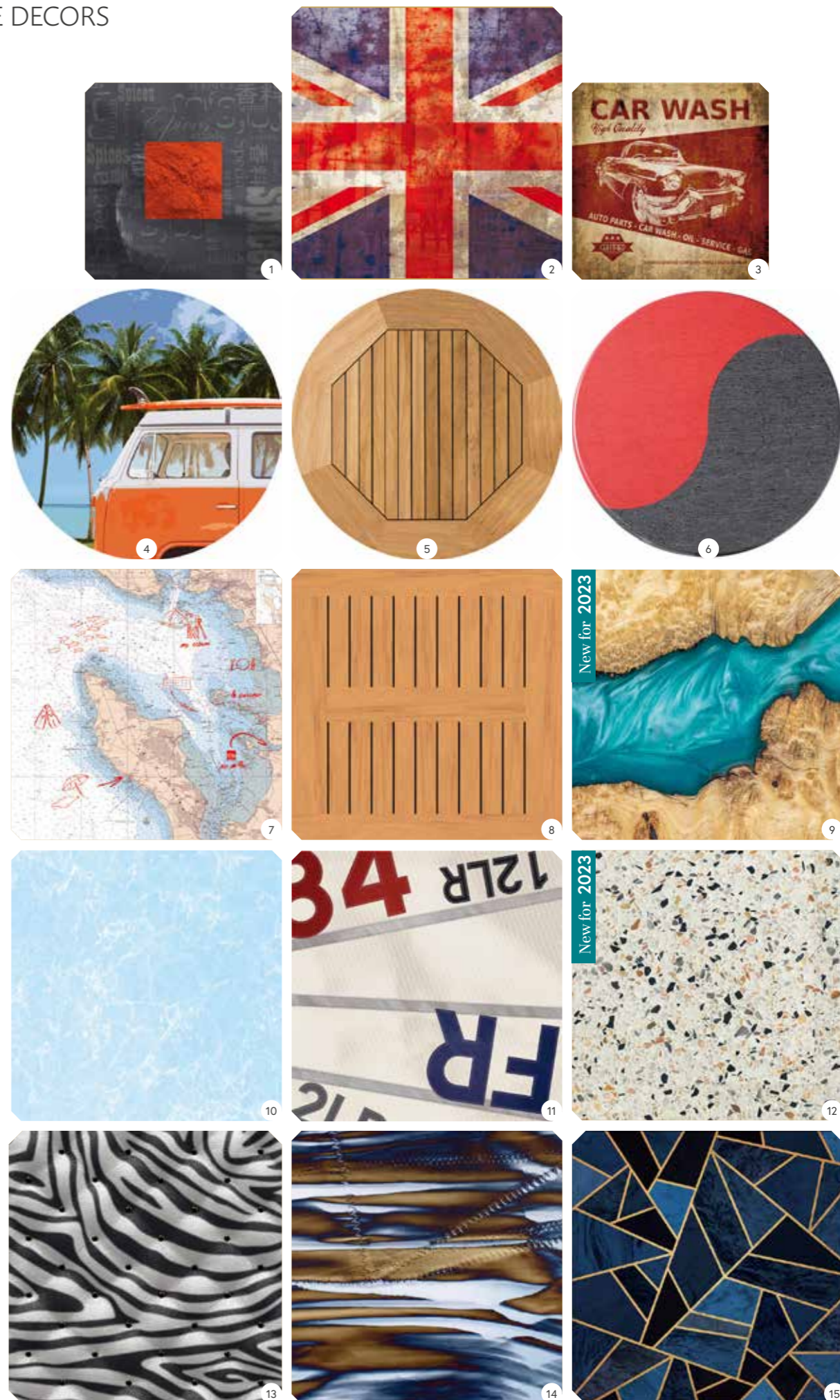

EASY PERSO

TAILOR MADE

A TABLE TOP WITH YOUR IDENTITY

The Easy Perso table top allows you to **easily and quickly** create a table top that suits you. Play with our **4 finishes and our 16 colours for more than 60 possibilities**, add your logo and voila. Logo with minimum 300 dpi resolution & 1:1 scale to provide.

SUPPORT

- | | | |
|---|--|---|
| <input checked="" type="checkbox"/> Round | <input checked="" type="checkbox"/> Square | <input checked="" type="checkbox"/> Rectangle |
| <input type="checkbox"/> Ø 60 | <input type="checkbox"/> 60X60 | <input type="checkbox"/> 70X60 |
| <input type="checkbox"/> Ø 60 BISTRO | <input type="checkbox"/> 70X70 | <input type="checkbox"/> 80X60 |
| <input type="checkbox"/> Ø 70 | <input type="checkbox"/> 80X80 | <input type="checkbox"/> 100X60 |
| <input type="checkbox"/> Ø 70 BISTRO | <input type="checkbox"/> 90X90 | <input type="checkbox"/> 110X70 |
| <input type="checkbox"/> Ø 80 | | <input type="checkbox"/> 120X80 |
| <input type="checkbox"/> Ø 90 | | |

BACKGROUND



A - wood

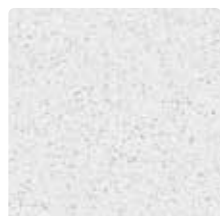

B - granite

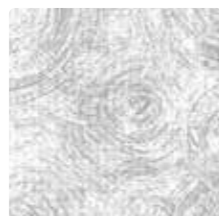

C - brushed

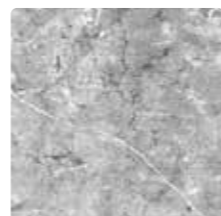

D - marble

BACKGROUND COLOR

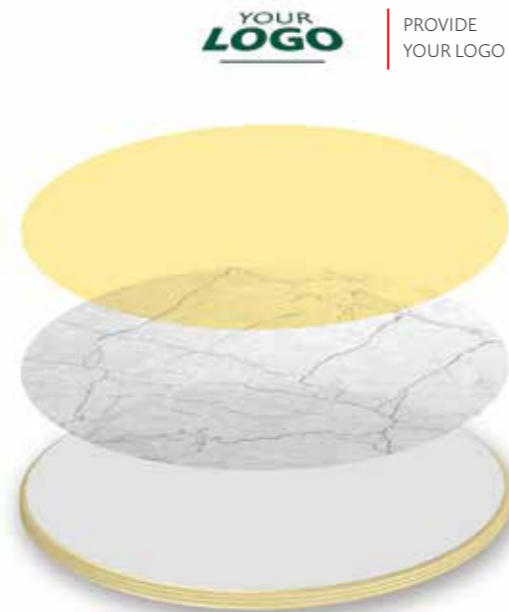
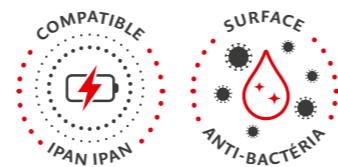
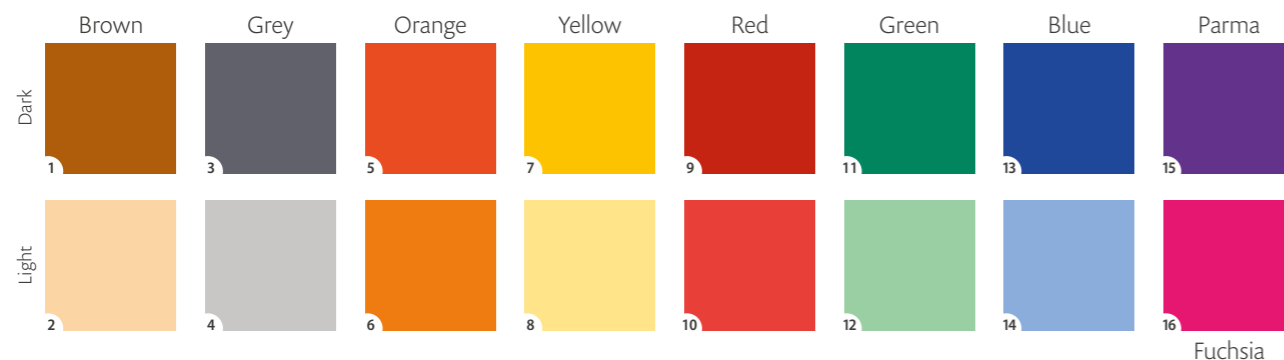

PROVIDE YOUR LOGO

CHOOSE YOUR COLOR

CHOOSE YOUR BACKGROUND

CHOOSE YOUR SUPPORT (Shape, size, with or without bistro finish)

TAILOR MADE

PERSO

PERSONALIZED TABLES TOP WITH YOUR DECOR

1. Choose:
 - the shape (round, square or rectangle)
 - the size
2. Send us by email your logo* in minimum 300 DPI resolution.

We create an 100% personalized support, table tops in total adequacy with the image of your business.

***To send us:**
Digital file of your logo (eps, ai, pdf, psd, jpg)
Resolution HD 300 dpi minimum Scale 1:1
For technical reasons, we prefer non-plain decors and colourful.

> See technical costs and current prices.

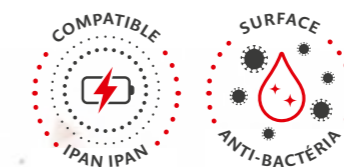



CARINO

INTERIOR & EXTERIOR



MADE IN THE
EUROPEAN UNION

Carino table top is an elegant solution offered by Werzalit. This standard collection offers a wide variety of decors and finishes for terraces, uncluttered and contemporary, while meeting the quality and price expectations of professionals. These table tops are customizable and furthermore, UV resistant.

3 EDGE SHAPES

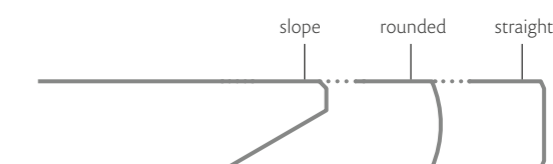

10 - 12 mm thick
Original size

CARINO

COMPACT HPL



CUSTOMIZABLE TABLE TOPS

The Carino collection, in addition to its remarkable aesthetic appearance, **is UV resistant and is designed for outdoor and indoor use.** It is compatible with all the decors of the Top 30 and The Unmissables range. Ask us for more details.

FINISHES

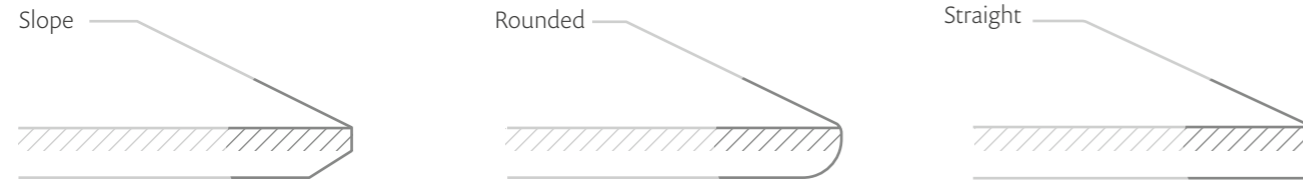

FIXING SOLUTIONS

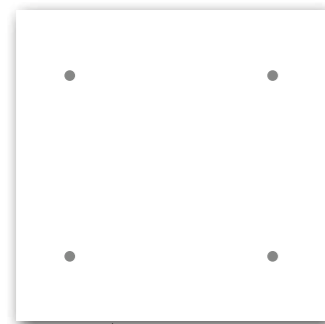

Fixing 1
Installation of inserts for M6 screws.

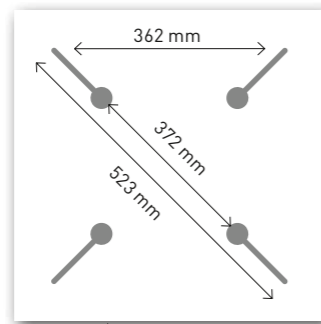

Fixing 2
The secure mounting system using grooves milled on one side allows the tops to be fixed to all conventional bases without drilling. Groove length 200 mm.
> Special bolts provided.

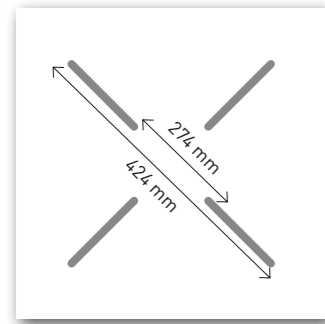

Fixing 3
The Eco fixing system consists of a 10 mm wide rail, in which we fix the bases using special 6x12 screws.
> Screws included.
> Only available for 10mm Carino.

○ ROUND				□ SQUARE					□ RECTANGLE							OTHER SIZES	
Ø 60	Ø 70	Ø 80	Ø 90	50x50	60x60	70x70	80x80	90x90	70x60	100x60	110x70	120x80	140x70	140x80	160x80	160x90	on demand
.	

Our HPL products are manufactured in accordance with the EN 438-6 standard

THE DECORS



CARINO table are also available in the other decors of the Unmissables, you can find them in pages 26/27. Do not hesitate to consult us.

Interior
CAMBIUM

FORM	CIRCLE / FRAMED	IPAN IPAN	SIZE	THICKNESS	EDGE SHAPE	WEIGHT
			Ø 60 cm	21 - 29 - 39 mm		4,7 kg
			60 x 60 cm	21 - 29 - 39 mm		4,2 kg
			65 x 65 cm	21 - 29 - 39 mm		5,9 kg
			70 x 70 cm	21 - 29 - 39 mm		8,3 kg
			70 x 60 cm	21 - 29 - 39 mm		7 kg
			120 x 70 cm	21 - 29 - 39 mm		9,9 kg

Interior
MASSIF

FORM	CIRCLE / FRAMED	IPAN IPAN	SIZE	THICKNESS	EDGE SHAPE	WEIGHT
			Ø 60 cm	22 mm		10,2 kg
			Ø 70 cm	22 mm		11,9 kg
			Ø 115 cm	22 mm		19,6 kg
			60 x 60 cm	22 mm		7,9 kg
			70 x 70 cm	22 mm		10,7 kg
			70 x 60 cm	22 mm		9,2 kg
			115 x 70 cm	22 mm		15 kg

Interior & Exterior
CARINO

FORM	CIRCLE / FRAMED	IPAN IPAN	SIZE	THICKNESS	EDGE SHAPE	WEIGHT
			Ø 60 cm	10 - 12 mm		4,7 kg
			Ø 70 cm	10 - 12 mm		6,5 kg
			Ø 80 cm	10 - 12 mm		8,4 kg
			Ø 90 cm	10 - 12 mm		10,6 kg
			50 x 50 cm	10 - 12 mm		4,2 kg
			60 x 60 cm	10 - 12 mm		5,9 kg
			70 x 70 cm	10 - 12 mm		8,3 kg
			80 x 80 cm	10 - 12 mm		10,8 kg
			90 x 90 cm	10 - 12 mm		13,5 kg
			70 x 60 cm	10 - 12 mm		7 kg
			100 x 60 cm	10 - 12 mm		9,9 kg
			110 x 70 cm	10 - 12 mm		12,8 kg
			120 x 80 cm	10 - 12 mm		16 kg
			140 x 70 cm	10 - 12 mm		16,3 kg
			140 x 80 cm	10 - 12 mm		18,6 kg
			160 x 80 cm	10 - 12 mm		21,3 kg
			160 x 90 cm	10 - 12 mm		23,9 kg

JAZZY

	FORM	CIRCLE / FRAMED	IPAN IPAN	SIZE	THICKNESS	EDGE SHAPE	WEIGHT
FUSION				Ø 60 cm	25 mm		6 kg
				Ø 80 cm	25 mm		10 kg
CYMBAL				80 x 80 cm	25 mm		13 kg
JAZZY				70 x 60 cm	25 mm		7 kg

TOP 30 & THE UNMISSABLE, POD, EASY PERSO, PERSO

FORM	CIRCLE / FRAMED	IPAN IPAN	SIZE	THICKNESS	EDGE SHAPE	WEIGHT	CONDITIONING
			Ø 40 cm	26 mm		2 kg	330
			Ø 60 cm	26 mm		4,3 kg	100
			Ø 70 cm	26 mm		5,7 kg	80
			Ø 80 cm	26 mm		6,9 kg	80
			Ø 90 cm	26 mm		9 kg	70
			Ø 100 cm	26 mm		10,8 kg	70
			Ø 105 cm	35 mm		12,5 kg	70
			Ø 120 cm	35 mm		16 kg	70
			55 x 55 cm	35 mm		4,8 kg	-
			60 x 60 cm	35 mm		5,7 kg	100
			70 x 70 cm	35 mm		8,4 kg	50
			80 x 80 cm	35 mm		11 kg	50
			90 x 90 cm	35 mm		13,6 kg	50
			70 x 60 cm	35 mm		6,9 kg	50
			80 x 60 cm	35 mm		8 kg	50
			110 x 70 cm	35 mm		11,3 kg	50
			120 x 80 cm	35 mm		15,5 kg	50

TECHNICAL CHARACTERISTICS TOP 30 & THE UNMISSABLE, POD, EASY PERSO, PERSO

ADVANTAGE

- A complete range
- Recognized professional use
- A design that makes the difference
- Over 99.7% of bacteria are eliminated with a simple cleaning with water and / or soap
- Robust and stable
- Resistance to bad weather, heat
- Excellent resistance to humidity
- Indoor and outdoor use

MAINTENANCE



Alcohol based solvent

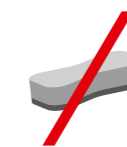

No abrasive cleaners



Do not stack

WARNING

If table tops are to remain in bright sunshine it is strongly advised to select light colours.



TABLE BASES

Werzalit offers you a complete, technological and innovative selection of table bases. Qualitative and functional, our bases allow you to accommodate your customers at robust and comfortable tables. They are, on the other hand, convenient to store or move.

werzalit®

since 1923.

GET EVEN!

WITH CONTACT^{X4} : WERZALIT'S
SELF STABILISING TABLE BASE

The ideal solution for excellent service and optimal comfort for your customers

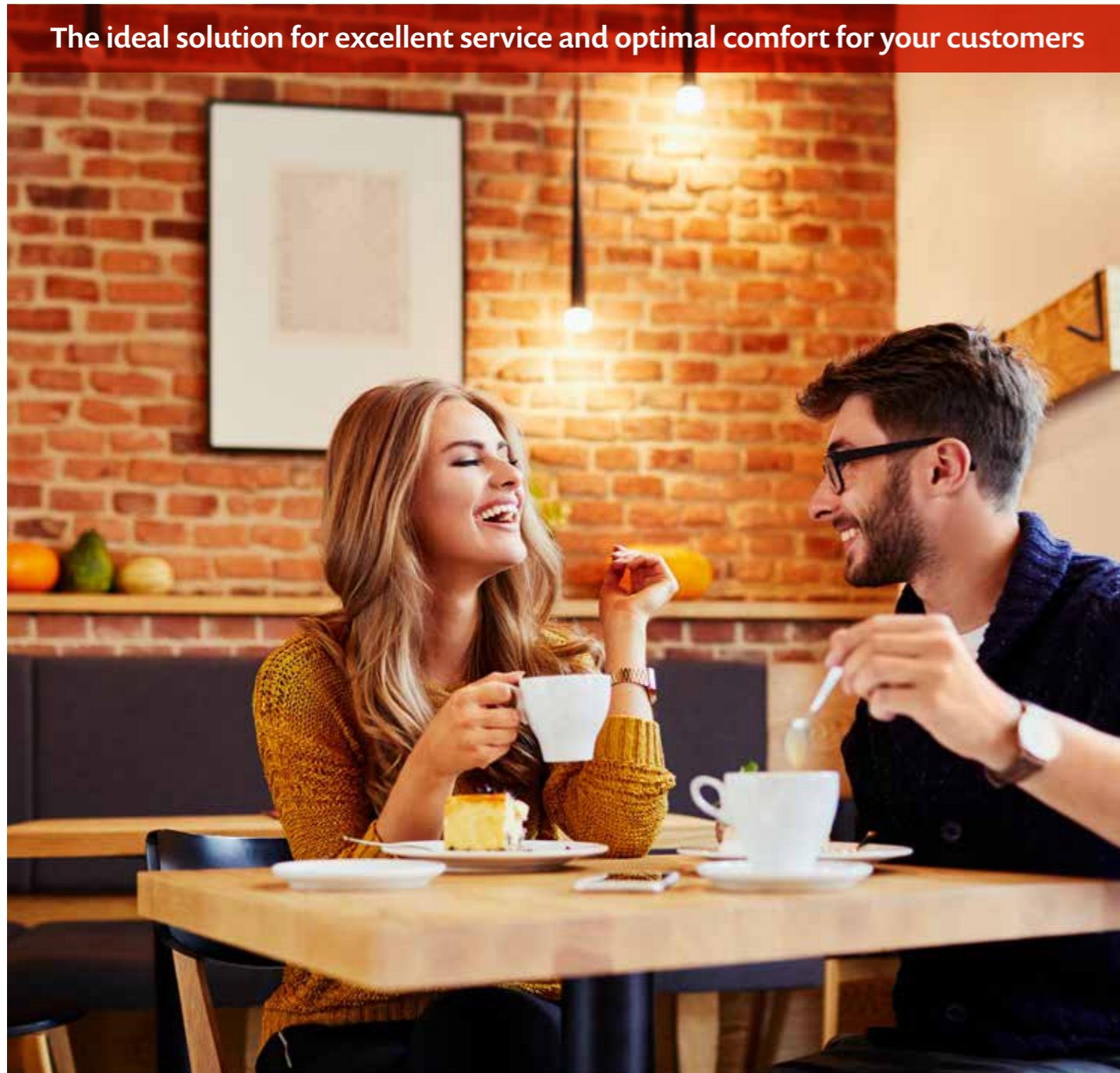

SELF STABILISING

Self-stabilizing table bases which adapt to all types of ground without external intervention.

CONTACT^{X4}

INNOVATION

SELF-STABILIZING BASE

Thanks to patented technology, the CONTACT^{X4} self-stabilizing base adapts to any irregular surface: cobbled streets, gravel, grass, clay. Simply place the table and the feet adapt to the layout of the floor with a simple and quick manipulation.

- > Essential comfort for consumers.
- > Time saving for you and impeccable service for professionals.

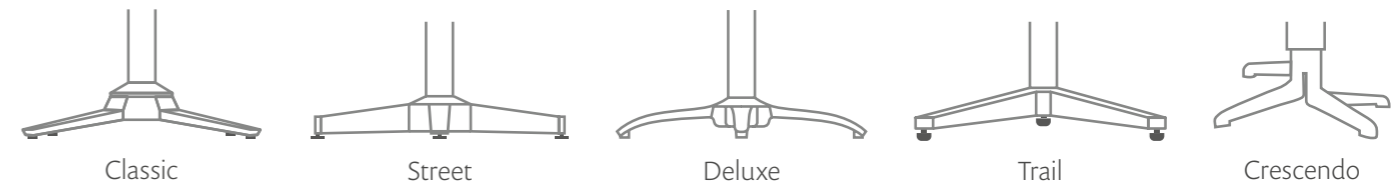

CONTACT^{X4}

CLASSIC



NOROCK

Self-stabilizing

Black

Silver



CONTACT^{X4}
CLASSIC
SILVER

CONTACT^{X4}
CLASSIC
BLACK
REF 058122

TOP 15

	BLACK	SILVER	WIDTH	LENGTH	HEIGHT	WEIGHT	MAX SIZE
CLASSIC TOP 15	058122	058122	47 cm	51,5 cm	71 cm	4,7 kg	Ø 80; 80x80; 70x60 cm
CLASSIC MD	058973	058972			110 cm	5,4 kg	Ø 70; 70x70; 70x60 cm

CONTACT X4

DELUXE

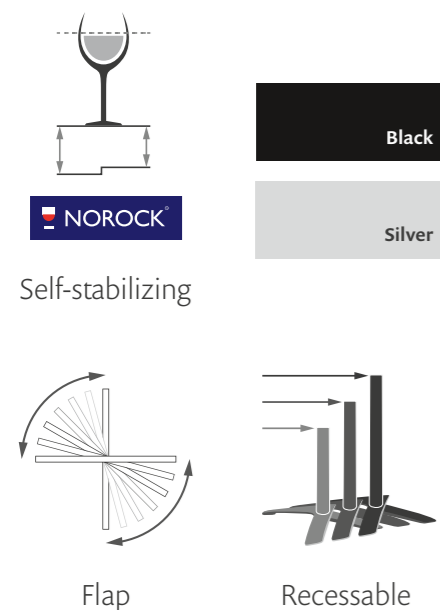

CONTACT X4

LUNA

PURE DESIGN & FEATURES

These are the promises of the CONTACT x4 Luna.
First self-stabilizing with 20mm adjustably to compensate for uneven surfaces.



	BLACK	SILVER	WIDTH	LENGTH	HEIGHT	WEIGHT	MAX SIZE
DELUXE TOP 15	058124	058125	47 cm	51,5 cm	71 cm	5,4 kg	Ø 80; 80x80; 70x60 cm
DELUXE MD	058975	058974			110 cm	6,1 kg	Ø 70; 70x70; 70x60 cm
LUNA	064298		Ø 53 cm		71 cm	14,5 kg	Ø 80; 80x80

CONTACT X4

TRAIL

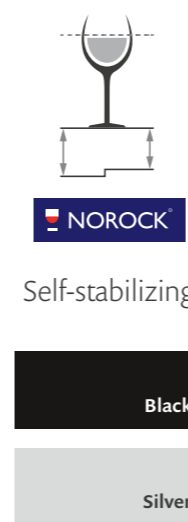

CONTACT X4

STREET

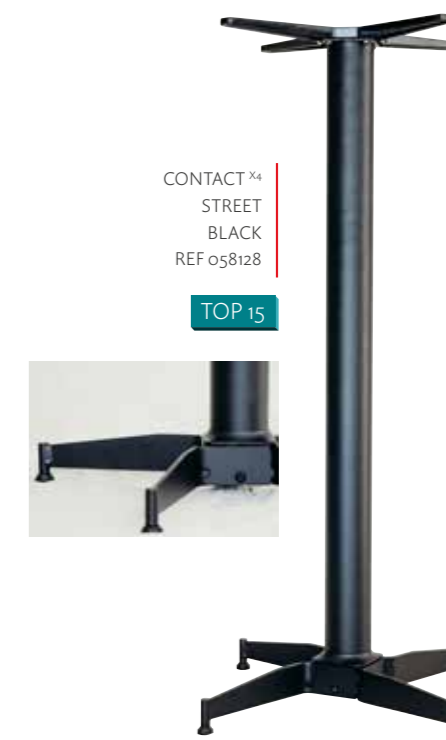
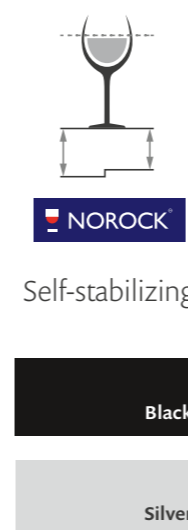

	BLACK	SILVER	WIDTH	LENGTH	HEIGHT	WEIGHT	MAX SIZE
X4 TRAIL TOP 15	058126	058127	46 cm	46 cm	71 cm	6 kg	Ø 80; 80x80 cm
X4 TRAIL MD	059134	059133			110 cm	7,3 kg	Ø 70; 70x70 cm
T-BASE	067962	082506	50 cm	91,5 cm	71,5 cm	13,6 kg	120x80 cm
X4 STREET TOP 15	058128	058129	46 cm	46 cm	71 cm	7,2 kg	Ø 80; 80x80 cm
X4 STREET MD	058923	058922			110 cm	8,4 kg	Ø 70; 70x70 cm
T-BASE	082534		50 cm	91,5 cm	71,5 cm	13,6 kg	120x80 cm

CONTACT X4

CRESCENDO



Self-stabilizing

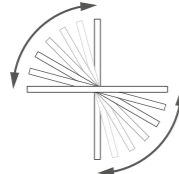

Flap



Suitable for persons with reduced mobility



Adjusts in height from 72 to 108 cm



Black



Scan this QR Code and discover how the Contact X4 Crescendo works



	REFERENCE	WIDTH	LENGTH	HEIGHT	WEIGHT	MAX SIZE
CRESCENDO	o8461o	68 cm	68 cm	from 72 to 108 cm	8 kg	Ø 70 cm; Ø 80 cm; 70 x 70 cm; 80 x 80 cm

TOP 15

TABLE BASES **TOP 15**

NEW SERVICE

YOUR ORDERS

DELIVERED IN RECORD TIME

The Top 15 Bases are available from our french warehouse site within 5 working days. There are a total of 15 references in line with your needs and ordering habits.

> Order directly and be delivered in record time with an order departure within 5 working days.

RONDA

Black

RONDA 55 MD
BLACK



RONDA 42 TB
BLACK



RONDA 55
BLACK
REF o347o3

TOP 15



	REFERENCE	WIDTH	LENGTH	HEIGHT	WEIGHT	MAX SIZE
RONDA 42 TB	o34572	Ø 42 cm		42,5 cm	14 kg	Ø 80; 80x80; 80x60 cm
RONDA 42	o347o4			72 cm		
RONDA 42 MD	o34536			108 cm	Ø 70; 70x70; 70x60 cm	
RONDA 55 TOP 15	o347o3	Ø 55 cm		72 cm	23 kg	Ø 120; 90x90; 110x70 cm
RONDA 55 MD	o3455			108 cm	24 kg	Ø 90; 80x80 cm

TRADITION

(NEW NAME OF THE BISTRO TABLE BASE)



Black



Bronze

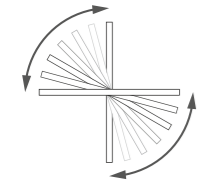

Flap

The range of Bistro bases comes from pure French tradition. The typical model of Parisian terraces.



TRADITION 4
REF 049481

TOP 15

AVAILABLE IN THE
KIT BISTRO
P77

AVAILABLE IN THE
KIT BISTRO
2
P77

AVANGARD

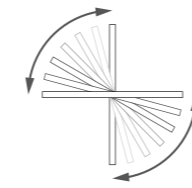

Flap

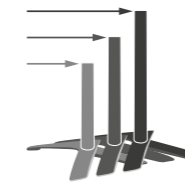

Recessable



Natural aluminium
suitable for the seaside



Natural aluminium



Anthracite



White

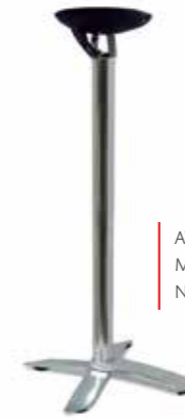

AVANGARD FLAP
MD
NATURAL ALUMINIUM



AVANGARD
FIXE
NATURAL ALUMINIUM



AVANGARD
FLAP
NATURAL ALUMINIUM
REF 034978

TOP 15

REFLEX

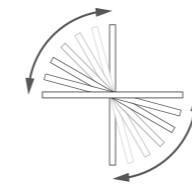

Flap

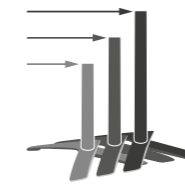

Recessable



Anthracite



Silver



REFLEX 3
FLAP
ANTHRACITE

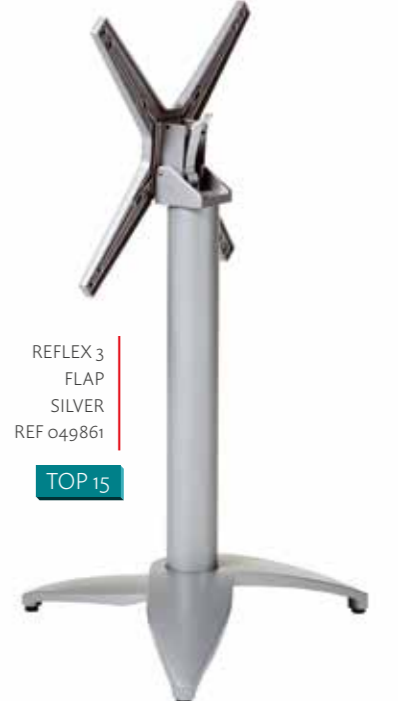

REFLEX 3
FLAP
SILVER
REF 049861

TOP 15



TRADITION 3
FLAP
BLACK
REF 060026

TOP 15

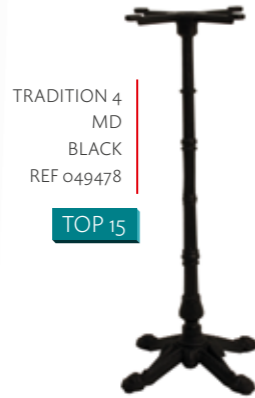

TRADITION 4
MD
BLACK
REF 049478

TOP 15



TRADITION 3
BRONZE*

TRADITION
LATERAL PM
BLACK



	REFERENCE	WIDTH	LENGTH	HEIGHT	WEIGHT	MAX SIZE
TRADITION TOP 15	049480	46 cm	41 cm	71,5 cm	12,4 kg	Ø 60 cm
TRADITION 3 Flap TOP 15	060026				6,5 kg	
TRADITION 3 BRONZE	060924				12,4 kg	
TRADITION 4 TOP 15	049481	39 cm	39 cm	108 cm	13,6 kg	Ø 70; 70x70 cm; 70x60 cm
TRADITION 4 MD TOP 15	049478				17,2 kg	Ø 70; 60x60 cm
TRADITION LATERAL PM	034862	39 cm	51 cm	71,5 cm	12 kg	Ø 70; 70x70 cm
TRADITION LATERAL GM	034861		81 cm		12,6 kg	80x80 cm; 80x60 cm

	ALU	ANTHRACITE	WHITE	SILVER	WIDTH	LENGTH	HEIGHT	WEIGHT	MAX SIZE
AVANGARD FIXE	034984				47 cm	51,5 cm	71 cm	6,5 kg	Ø 80; 80x80; 70x60 cm
AVANGARD FLAP TOP 15	034978	034983	047029				111,5 cm	8 kg	Ø 80; 70x60 cm
AVANGARD FLAP MD	034989	034994	054744						
REFLEX 3 FLAP TOP 15		055305		049861	52 cm	52 cm	72 cm	9 kg	Ø 70

TYA

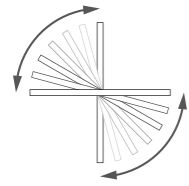

Flap

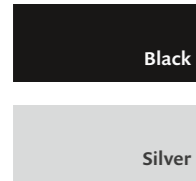

TYA 4
SILVER



TYA 4
BLACK
REF 049865

TOP 15

EVA

(NEW NAME OF THE AVE TABLE BASE)

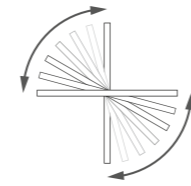

Flap

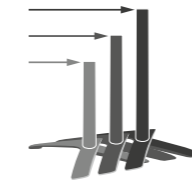

Recessable

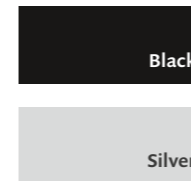

EVA 4
FLAP
BLACK
REF 053932

TOP 15



TYA
LATERAL FLAP
BLACK



TYA 4
FLAP
BLACK



TYA MD
FLAP
BLACK



EVA LATERAL
FLAP
SILVER



EVA 4 MD
FLAP
BLACK

	BLACK	SILVER	WIDTH	LENGTH	HEIGHT	WEIGHT	MAX SIZE
TYA 4 TOP 15	049865	049866	46 cm	46 cm	71 cm	2,4 kg	Ø 70; 70x70 cm
TYA 4 FLAP	049868	049869				2,8 kg	
TYA MD	049877	049878			114 cm	2,7 kg	
TYA MD FLAP	049880	049881				3,1 kg	
TYA LATERAL	049871	049872	62 cm	72 cm	71 cm	3,6 kg	110x70; 120x80 cm
TYA LATERAL FLAP	049874	049875				4,4 kg	

	BLACK	SILVER	WIDTH	LENGTH	HEIGHT	WEIGHT	MAX SIZE
EVA 4 FLAP TOP 15	053932	084529	52 cm	52 cm	72 cm	6,2 kg	Ø 80; 80x80; 80x60 cm
EVA 4 MD FLAP	060920	060921			110 cm	6,9 kg	
EVA LATERAL FLAP	060922	060923		95 cm	72 cm	9,5 kg	120x80 cm

BOLOGNA

Black



BOLOGNA 4
BLACK
REF 034794

TOP 15



BOLOGNA 3
BLACK



BOLOGNA
LATERAL
BLACK



BOLOGNA 4
SPEC
BLACK



BOLOGNA 4
MD
BLACK

	REFERENCE	WIDTH	LENGTH	HEIGHT	WEIGHT	MAX SIZE
BOLOGNA 3	034792	54 cm	54 cm	70 cm	4 kg	Ø 70 cm
BOLOGNA 4 TOP 15	034794	44 cm	44 cm		6 kg	Ø 80; 80x80; 80x60 cm
BOLOGNA 4 MD	046418	54 cm	54 cm	108 cm	11 kg	Ø 70; 70x70; 70x60 cm
BOLOGNA 4 SPEC	034795	66 cm	66 cm	70 cm	10 kg	Ø 120; 90x90 cm
BOLOGNA LATERAL	034796	59 cm	90 cm		9 kg	120x80 cm

ROMA

Natural aluminium



ROMA
LATERAL
NATURAL ALU



ROMA 3
NATURAL ALU



ROMA 3 MD
NATURAL ALU

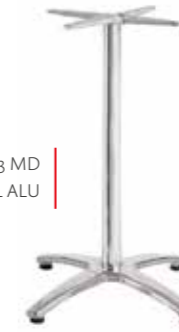

ROMA 4
NATURAL ALU



CROSS

Black

Silver



CROSS
LATERAL
BLACK



CROSS 4 MD
BLACK



CROSS 4
BLACK

	BLACK	SILVER	ALU	WIDTH	LENGTH	HEIGHT	WEIGHT	MAX SIZE
ROMA 3			046228	51 cm	51 cm	71 cm	7 kg	Ø 70 cm
ROMA 4			046227	47 cm	47 cm		8 kg	Ø 80; 70x70; 70x60 cm
ROMA MD			046389			108 cm	9,2 kg	Ø 70; 70x70; 70x60 cm
ROMA LATERAL			046229	61,5 cm	72 cm	71 cm	11 kg	110x70; 120x80 cm
CROSS 4	059139	059140		40 cm	40 cm	73,5 cm	6 kg	Ø 80; 80x80 cm
CROSS 4 MD	059135	059136				115 cm	7,4 kg	Ø 70; 70x70; 70x60 cm
CROSS LATERAL	059137	059138		60 cm	63 cm	73,5 cm		



PENTA INOX

Inox

PENTA
ROUND
INOX



PENTA
SQUARE MD
INOX



PENTA
SQUARE
INOX



EROS

Black

White

EROS
80X80
WHITE



EROS
110X70
BLACK



PENTA

Black

Silver

PENTA
ROUND
SILVER

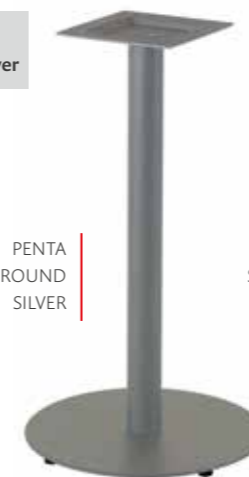

PENTA
SQUARE
BLACK



PENTA
SQUARE MD
SILVER



PENTA
RECTANGLE
BLACK



	WHITE	BLACK	WIDTH	LENGTH	HEIGHT	WEIGHT	MAX SIZE
EROS 70X70	048552	034691	63,5 cm	63,5 cm	72 cm	4,5 kg	70x70 cm
EROS 80X80	047296	034692	73,5 cm	73,5 cm		5 kg	80x80 cm
EROS 110X70	049469	034693	63,5 cm	103,5 cm			110x70 cm
EROS 120X80	048616	034694	73,5 cm	113,5 cm		5,5 kg	120x80 cm

	INOX	BLACK	SILVER	WIDTH	LENGTH	HEIGHT	WEIGHT	MAX SIZE
PENTA ROUND	083135	083132	083133	Ø 42 cm		72 cm	14 kg	Ø 80; 80x80; 80x60 cm
PENTA SQUARE	083134	083130	083131	39 cm	39 cm	73 cm	14,5 kg	
PENTA SQUARE MD	057292	057291	057290			111 cm	16 kg	Ø 70; 70x70; 70x60 cm
PENTA RECTANGLE		085114	058202		59 cm	72 cm	19 kg	120x80 cm



TABLE TOP NOT AVAILABLE



TABLE TOP NOT AVAILABLE

MAESTRO

OCTAVE

SWING

RIFF



AVAILABLE IN BLACK
OTHER COLOURS ON DEMAND
TABLE BASE SOLD ALONE
TABLE TOP NOT AVAILABLE



SWING
BLACK



	REFERENCE	WIDTH	LENGTH	HEIGHT	WEIGHT	MAX SIZE
OCTAVE	o84604	65 cm	65 cm	73 cm	10,5 kg	Ø 80; Ø 100; 70x70; 80x80 cm
MAESTRO	o84608	50 cm		73 cm	19,5 kg	Ø 80; Ø 100; 70x70; 80x80 cm

	REFERENCE	WIDTH	LENGTH	HEIGHT	WEIGHT	MAX SIZE
SWING	o84605		Ø 60 cm	72 cm	9,5 kg	Ø 90; Ø 100; Ø 120 cm
RIFF	EXT o84747 INT o84607	Ø 65 cm	Ø 65 cm	73 cm	5,5 kg	Ø 70; Ø 80; 70x70; 80x80; 70x60 cm

RHYTHM

Black

TABLE BASE SOLD ALONE
TABLE TOP NOT AVAILBLE



BEATS

Black



BEATS
BLACK

	REFERENCE	WIDTH	LENGTH	HEIGHT	WEIGHT	MAX SIZE
RHYTHM	o84603	Kit 4 feet		73 cm	7 kg	Ø 80 ; Ø 100 ; 70x70 ; 80x80 ; 90x90 ; 120x80 ; 140x80 ; 160x80 cm
BEATS	o84609	70 cm	70 cm	72,5 cm	14 kg	Ø 100 ; Ø 120 ; 80x80 ; 90x90 cm

SHIMMY



Flap



SHIMMY BASE
MD WHITE
ON DEMAND

JAZZY LIGHT TOP
ON DEMAND



SHIMMY BLACK BASE
JAZZY CHEVRON TOP

TIPI



Flap

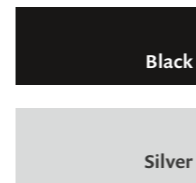

TIPI 4
BLACK



TIPI 4
SILVER



TIPI 3
FLAP
BLACK



	BLACK	SILVER	WIDTH	LENGTH	HEIGHT	WEIGHT	MAX SIZE
SHIMMY	o84606		56 cm	56 cm	73 cm	6 kg	Ø 60 ; Ø 70 cm
TIPI 3	o83140	o83141	58 cm	58 cm	73 cm	6 kg	Ø 60 ; Ø 70 cm
TIPI 3 FLAP	o61204	o61205				7,5 kg	
TIPI 4	o83142	o83143	65 cm	65 cm		7 kg	Ø 80 ; 80x80 cm
TIPI 4 FLAP	o61206	o61207				8,5 kg	

ELIO



ELIO 3
SILVER



ELIO 4
BLACK

NICE



NICE
BLACK

ROCHELLE



ROCHELLE 1
WHITE

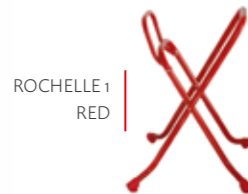

ROCHELLE 1
RED



ROCHELLE 1
SILVER



ROCHELLE 1
BLACK

BOOMRANG

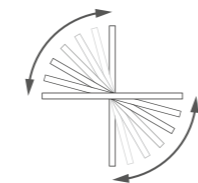

Flap

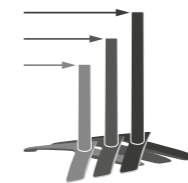

Recessable



BOOMRANG
FLAP
SILVER



BOOMRANG
FLAP
ANTHRACITE

	BLACK	WHITE	SILVER	RED	WIDTH	LENGTH	HEIGHT	WEIGHT	MAX SIZE
ELIO 3	083136		083137		56 cm	56 cm	73 cm	5 kg	Ø 80 cm
ELIO 4	083138		083139		47 cm	47 cm		5,5 kg	Ø 80; 80x80; 80x60 cm
ROCHELLE 1	058851	058849	058850	058854	40 cm	39 cm	71 cm	2,6 kg	Ø 80; 70x70; 100x60 cm
ROCHELLE 2	058853	058852	058846	060434		59 cm		3 kg	Ø 120; 90x90; 120x80 cm

	BLACK	ANTHRACITE	SILVER	WIDTH	LENGTH	HEIGHT	WEIGHT	MAX SIZE
NICE	049472			40 cm	40 cm	73 cm	11,3 kg	Ø 70; 70x70; 70x60 cm
BOOMRANG FLAP		048388	046684	51,5 cm	51,5 cm	71 cm	5 kg	Ø 90; 90x90 cm
BOOMRANG FLAP MD		048664	048665			111,5 cm	6,6 kg	Ø 80; 80x80 cm

	MODEL	WIDTH	LENGTH	HEIGHT	WEIGHT	FINISH	MATERIALS	MAX TOP SIZE
	AVANGARD FIXE	47 cm	51,5 cm	71 cm	6,5 kg	Natural aluminium TOP 15 Anthracite White	Aluminium	Ø 80; 80x80; 70x60 cm
	AVANGARD FLAP			111,5 cm	8 kg			Ø 80; 70x60 cm
	AVANGARD FLAP MD							
	BEATS	70 cm	70 cm	72,5 cm	14 kg	Black	Powdered steel	Ø 100 ; Ø 120 ; 80x80 ; 90x90 ; 120x80 cm
	BOLOGNA 3	54 cm	54 cm	70 cm	4 kg	Black	Cast aluminum	Ø 70 cm
	BOLOGNA 4	44 cm	44 cm	70 cm	6 kg			Ø 80; 80x80; 80x60 cm
	BOLOGNA 4 MD	54 cm	54 cm	108 cm	11 kg			Ø 70; 70x70; 70x60 cm
	BOLOGNA 4 SPEC	66 cm	66 cm	70 cm	10 kg			Ø 120; 90x90 cm
	BOLOGNA LATERAL	59 cm	90 cm	70 cm	9 kg			120x80 cm
	BOOMRANG FLAP	51,5 cm	51,5 cm	71 cm	5 kg	Anthracite silver	Aluminium	Ø 90; 90x90 cm
	BOOMRANG FLAP MD	51,5 cm	51,5 cm	111,5 cm	6,6 kg			Ø 80; 80x80 cm
	CONTACT 34 CLASSIC	47 cm	51,5 cm	71 cm	4,7 kg	Black TOP 15 Silver	Aluminium	Ø 80; 80x80; 70x60 cm
	CONTACT 34 CLASSIC MD	47 cm	51,5 cm	110 cm	5,4 kg			Ø 70; 70x70; 70x60 cm
	CONTACT 34 CRESCENDO	68 cm	68 cm	71 à 108 cm	8 kg	Black	Aluminium	Ø 70 cm; Ø 80 cm; 70 x 70 cm; 80 x 80 cm
	CONTACT 34 DELUXE	47 cm	51,5 cm	71 cm	5,4 kg	Black TOP 15 Silver TOP 15	Aluminium	Ø 80; 80x80; 70x60 cm
	CONTACT 34 DELUXE MD	47 cm	51,5 cm	110 cm	6,1 kg			Ø 70; 70x70; 70x60 cm
	CONTACT 34 LUNA	Ø 53 cm		71 cm	14,5 kg	Black	Steel	Ø 80; 80x80 cm
	CONTACT 34 LUNA MD	Ø 53 cm		110 cm	15,4 kg			Ø 70; 70x70 cm
	CONTACT 34 T-BASE	50 cm	91,5 cm	71,5 cm	13,6 kg	Black silver	Steel	120x80 cm
	CONTACT 34 TRAIL	46 cm	46 cm	71 cm	6 kg	Black TOP 15 Silver	Steel	Ø 80; 80x80 cm
	CONTACT 34 TRAIL MD	46 cm	46 cm	110 cm	7,3 kg			Ø 70; 70x70 cm
	CONTACT 34 STREET	46 cm	46 cm	71 cm	7,2 kg	Black TOP 15 Silver	Steel	Ø 80; 80x80 cm
	CONTACT 34 STREET MD	46 cm	46 cm	110 cm	8,4 kg			Ø 70; 70x70 cm
	CROSS 4	40 cm	40 cm	73,5 cm	6 kg	Black Silver	Aluminium Steel pipe	Ø 80; 80x80 cm
	CROSS 4 MD	40 cm	40 cm	115 cm	7,4 kg			Ø 70; 70x70; 70x60 cm
	CROSS LATERAL	60 cm	63 cm	73,5 cm	7,4 kg			120x80 cm
	ELIO 3	56 cm	56 cm	73 cm	5 kg	Black Silver	Steel	Ø 80 cm
	ELIO 4	47 cm	47 cm	73 cm	5,5 kg			Ø 80; 80x80; 80x60 cm
	EROS 70x70	63,5 cm	63,5 cm	72 cm	4,5 kg	White Black	Aluminium	70x70 cm
	EROS 80x80	73,5 cm	73,5 cm	72 cm	5 kg			80x80 cm
	EROS 110x70	63,5 cm	103,5 cm	72 cm	5 kg			110x70 cm
	EROS 120x80	73,5 cm	113,5 cm	72 cm	5,5 kg			120x80 cm
	EVA 4 FLAP	52 cm	52 cm	72 cm	6,2 kg	Black TOP 15 Silver	Aluminium	Ø 80; 80x80; 80x60 cm
	EVA 4 MD FLAP			110 cm	6,9 kg			
	EVA LATERAL FLAP			72 cm	9,5 kg			120x80 cm
	MAESTRO	50 cm	50 cm	73 cm	19,5 kg	Chrome	Inox	Ø 80 ; Ø 100 ; 70x70 ; 80x80 cm
	NICE 4	40 cm	40 cm	73 cm	11,3 kg	Black	Cast iron	Ø 70; 70x70; 70x60 cm
	OCTAVE	65 cm	65 cm	73 cm	10,5 kg	Black	Powdered steel	Ø 80 ; Ø 100 ; 70x70 ; 80x80 cm

	MODEL	WIDTH	LENGTH	HEIGHT	WEIGHT	FINISH	MATERIALS	MAX TOP SIZE
	PENTA ROUND	Ø 42 cm		72 cm	14 kg	Black Silver	Steel	Ø 80; 80x80; 80x60 cm
	PENTA SQUARE	39 cm	39 cm	73 cm	14,5 kg			Ø 70; 70x70; 70x60 cm
	PENTA SQUARE MD	39 cm	39 cm	111 cm	16 kg			120x80 cm
	PENTA RECTANGLE	39 cm	59 cm	72 cm	19 kg			
	PENTA INOX ROUND	Ø 42 cm		72 cm	14 kg	Inox	Inox	Ø 80; 80x80; 80x60 cm
	PENTA INOX SQUARE	39 cm	39 cm	73 cm	14,5 kg			Ø 70; 70x70; 70x60 cm
	PENTA INOX SQUARE MD	39 cm	39 cm	111 cm	16 kg			
	REFLEX 3 FLAP	52 cm	52 cm	72 cm	9 kg	Anthracite silver TOP 15	Aluminium	Ø 60 ; Ø 70 cm
	RHYTHM	Kit 4 feet		73 cm	7 kg	Black	Steel	Ø 80 ; Ø 100 ; 70x70 ; 80x80 ; 90x90 ; 120x80 ; 140x80 ; 160x80 cm
	RIFF	65 cm	65 cm	73 cm	5,5 kg	Black	Powdered steel	Ø 70; Ø 80 ; 70x70; 80x80 ; 70x60 cm
	ROCHELLE 1	40 cm	39 cm	71 cm	2,6 kg	White Black Silver Red	Steel	Ø 80; 70x70; 100x60 cm
	ROCHELLE 2	40 cm	59 cm	71 cm	3 kg			Ø 120; 90x90; 120x80 cm
	ROMA 3	51 cm	51 cm	71 cm	7 kg	Natural aluminium	Aluminium	Ø 60 ; Ø 70 cm
	ROMA 4	47 cm	47 cm	71 cm	8 kg			Ø 80; 70x70; 70x60 cm
	ROMA MD	47 cm	47 cm	108 cm	9,2 kg			Ø 70; 70x70; 70x60 cm
	ROMA LATERAL	61,5 cm	72 cm	71 cm	11 kg			110x70; 120x80 cm
	RONDA 42 TB	Ø 42 cm		42,5 cm	14 kg	Black	Steel	Ø 80; 80x80; 80x60 cm
	RONDA 42	Ø 42 cm		72 cm	14 kg			Ø 70; 70x70; 70x60 cm
	RONDA 42 MD	Ø 42 cm		108 cm	18 kg			Ø 120; 90x90; 110x70 cm
	RONDA 55	Ø 55 cm		72 cm	23 kg			Ø 90; 80x80 cm
	RONDA 55 MD	Ø 55 cm		108 cm	24 kg			
	SHIMMY	56 cm	56 cm	73 cm	6 kg	Black	Powdered steel	Ø 60 ; Ø 70 cm
	SWING	60 cm	60 cm	72 cm	9,5 kg	Black	Powdered steel	Ø 90 ; Ø 100 ; Ø 120 cm
	TIPI 3	58 cm	58 cm	73 cm	6 kg	Black Silver	Steel	Ø 60 ; Ø 70 ; Ø 80 cm
	TIPI 3 FLAP	58 cm	58 cm	73 cm	7,5 kg			Ø 80; 80x80 cm
	TIPI 4	47 cm	47 cm	73 cm	7 kg			
	TIPI 4 FLAP	47 cm	47 cm	73 cm	8,5 kg			
	TRADITION 3	41 cm	41 cm	71,5 cm	12,4 kg	Black	Cast iron	Ø 60 cm
	TRADITION 3 FLAP				6,5 kg			Ø 70; 70x70; 70x60 cm
	TRADITION 4	39 cm	39 cm	108 cm	13,6 kg			Ø 70 ; 60x60 cm
	TRADITION 4 MD				17,2 kg			80x80; 80x60 cm
	TRADITION LATERAL PM	39 cm	51 cm	71,5 cm	12 kg			120x80 cm
	TRADITION LATERAL GM		81 cm		12,6 kg			
	TYA 4	46 cm	46 cm	71 cm	2,4 kg	Black TOP 15 Silver	Aluminium	Ø 70; 70x70 cm
	TYA 4 FLAP	46 cm	46 cm	71 cm	2,4 kg			
	TYA MD	46 cm	46 cm	114 cm	2,7 kg			
	TYA MD FLAP	46 cm	46 cm	114 cm	2,7 kg			
	TYA LATERAL	62 cm	72 cm	71 cm	3,6 kg			
	TYA LATERAL FLAP	62 cm	72 cm	71 cm	3,6 kg			110x70; 120x80 cm

> TOP 15 : Order directly and be delivered in record time with an order departure within 5 working days.



CHAIRS & ARMCHAIRS

Comfortable and elegant, our selections of chairs allow you to welcome your customers in the best conditions. Chairs and armchairs move and store easily, in order to best organise your rooms and terraces.



CHANTILLY



TOP 10
 CHANTILLY CHAIR
 BAMBOO ALU PIPE
 REF 064327

W	47 cm
D	61 cm
H	94 cm
WT	4 kg



VINCENNES



TOP 10
 VINCENNES CHAIR
 BAMBOO ALU PIPE
 REF 064328

W	49 cm
D	58 cm
H	88 cm
S	46 cm
WT	4 kg

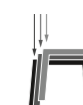

TOKYO



TOP 10
 TOKYO ARMCHAIR BLACK
 BLACK BATYLINE 5005
 REF 034438

W	57 cm
D	54 cm
H	84 cm
S	45 cm
WT	4,2 kg

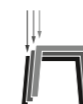

TOP 10
 TOKYO ARMCHAIR BLACK
 TAUPE BATYLINE 5014
 REF 048983

W	57 cm
D	54 cm
H	84 cm
S	45 cm
WT	4,2 kg



TOP 10
 TOKYO CHAIR BLACK
 BLACK BATYLINE 5005
 REF 058400

W	43 cm
D	48,5 cm
H	84 cm
S	45 cm
WT	3,5 kg

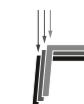

TOP 10

SEAT

TOP 10

The TOP 10 Chairs are available from our Rochefort site within **5 working days**. There are a total of **10 references** in line with your needs and ordering habits.

PARIS

Moka

White



TOP 10
 PARIS ARMCHAIR
 WHITE BAMBOO
 REF 058914

W	56,5 cm
D	53 cm
H	90 cm
WT	4,9 kg



TOP 10
 PARIS CHAIR
 WHITE BAMBOO
 REF 058912

W	42 cm
D	53 cm
H	90 cm
WT	3,8 kg



AVAILABLE IN THE
KIT BISTRO
 2
 P77

AVAILABLE IN THE
KIT BISTRO
 P77



TOP 10
 PARIS ARMCHAIR
 MOKA BAMBOO
 REF 058913

W	56,5 cm
D	53 cm
H	90 cm
WT	4,9 kg

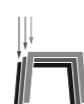

TOP 10
 PARIS CHAIR
 MOKA BAMBOO
 REF 058911

W	42 cm
D	53 cm
H	90 cm
WT	3,8 kg

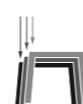

HAVANA



TOP 10
 HAVANA CHAIR
 BAMBOO LOOK ALU PIPE
 BEIGE ROPE
 REF 084560

W	59 cm
D	61 cm
H	83 cm
WT	3,5 kg



TOP 10
 HAVANA ARMCHAIR
 BAMBOO LOOK ALU PIPE
 BEIGE ROPE
 REF 084561

W	59 cm
D	61 cm
H	83 cm
WT	3,5 kg



PALERME



TOP 10
 PALERME ARMCHAIR
 ANTHRACITE KARIN
 ANTHRACITE ALU PIPE
 TAUPE ROPE
 TAUPE CUSHION
 REF 060928

W	59 cm
D	59 cm
H	82 cm
WT	5 kg



STRASBOURG TROCADERO



STRASBOURG ARMCHAIR
ANTHRACITE BRAIDED/WOVEN
REF 055391

W	57 cm
D	59 cm
H	79 cm
S	45 kg
WT	3,2 kg



TROCADERO ARMCHAIR
BLACK POLYPROPYLENE
REF 058873

W	46 cm
D	53 cm
H	80 cm
WT	3,5 kg



TROCADERO ARMCHAIR
BLACK BATYLINE
REF 058874

W	46 cm
D	53 cm
H	80 cm
WT	3,5 kg

PRAGUE



PRAGUE CHAIR
ANTHRACITE ALU PIPE
ANTHRACITE ROPE
REF 060934

W	53 cm
D	54 cm
H	78 cm
WT	3,5 kg



PRAGUE ARMCHAIR
ANTHRACITE ALU PIPE
ANTHRACITE ROPE
REF 060935

W	59 cm
D	57 cm
H	78 cm
WT	4,2 kg



PRAGUE STOOL
ANTHRACITE ALU PIPE
ANTHRACITE ROPE
REF 060936

W	57 cm
D	57 cm
H	113 cm
WT	4,5 kg

TOSCANA



TOSCANA ARMCHAIR
ANTHRACITE 5X5
REF 046729

W	56 cm
D	55 cm
H	86 cm
S	66 kg
WT	5,5 kg



TOSCANA CHAIR
ANTHRACITE 5X5
REF 034172

W	44 cm
D	55 cm
H	88 cm
WT	4 kg

KROMY

Green lemon
034185

Orange
034187

Red
034188

White
034183



KROMY CHAIR
RED
REF 034188

W	46 cm
D	53 cm
H	80 cm
WT	3,5 kg



KROMY 2

Black
034242

Cream
053998

White
053999



KROMY 2 CHAIR
BLACK
REF 034242

W	44 cm
D	50 cm
H	81 cm
S	45 kg
WT	3,3 kg



KROMY 2 ARMCHAIR
WHITE
REF 053999

W	53 cm
D	62 cm
H	82 cm
S	45 kg
WT	4 kg

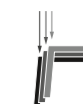

KING

Black
056106

Chocolat
058485

Taupe
055492

White
068107



KING ARMCHAIR
BLACK
REF 056106

W	60 cm
D	54 cm
H	82 cm
S	45 kg
WT	3,8 kg



SAINT-GERMAIN

In the spirit of **Parisian bars and restaurants**, our new **Saint-Germain** collection nicely completes our assortment of chairs and stools, combining the warm bamboo aesthetic with braiding. Composed of 4 coordinated references, it will find its place both on your terraces and in your rooms, inviting **conviviality and sharing moments together**.



It will do wonders in combination with our **elegant BISTRO collection!**



SAINT-GERMAIN CHAIR
BAMBOO
REF 084611

W	42 cm
D	53 cm
H	90 cm
WT	4 kg



SAINT-GERMAIN ARMCHAIR
BAMBOO
REF 084612

W	56,5 cm
D	53 cm
H	90 cm
WT	4,5 kg



SAINT-GERMAIN BARCHAIR
BAMBOO
REF 084614

W	56,5 cm
D	53 cm
H	118 cm
WT	6 kg



SAINT-GERMAIN BARSTOOL
BAMBOO
REF 084613

W	56 cm
D	56 cm
H	74 cm
WT	5 kg



JAZZ

Have **JAZZ**, put in music your interior design projects and create an incomparable atmosphere!

Sparkling, colourful, elegant, rhythmic, abundant, our collection JAZZ combines different materials and shapes to create an exuberant atmosphere, according to your inspiration. **Character and originality** are the key words.

BEBOP

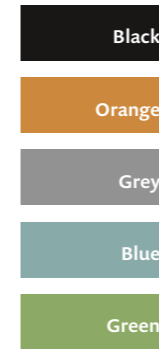

BEBOP CHAIR
GREY

W	44 cm
D	52 cm
H	80 cm
WT	3 kg



CALYPSO



CALYPSO CHAIR
BLACK

W	50 cm
D	75 cm
H	95 cm
WT	4 kg



HARMONY

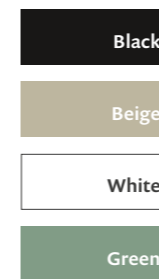

HARMONY CHAIR
BEIGE

W	49 cm
D	46 cm
H	81 cm
WT	4 kg



TEMPO

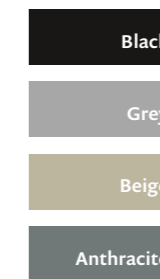

TEMPO CHAIR
BLACK
BLACK CUSHION

W	51,2 cm
D	51 cm
H	77,8 cm
WT	3,75 kg



GROOVE



















The first eco-responsible stool made in France from waste cereals from beer brewing. Removable and customizable. Assembles in minutes. Black powder coated steel structure.

GROOVE STOOL
BLACK

W	35 cm	35 cm
D	35 cm	35 cm
H	75 cm	65 cm
WT	8 kg	7 kg



TECHNICAL INFORMATIONS

			W	D	H	S	WT	COLOURS	STORAGE	MATERIALS	USE	REF.			W	D	H	S	WT	COLOURS	STORAGE	MATERIALS	USE	REF.						
BEBOP	chair		44 cm	52 cm	80 cm	-	3 kg	Black Orange Blue Green Grey	Stackable	Polypropylene	Interior & exterior	- 084616 084617 084618 084615		chair		53 cm	54 cm	78 cm	-	3,5 kg					060934					
CALYPSO	chair		50 cm	75 cm	95 cm	-	4 kg	Black	-	Polypropylene	Interior & exterior	084598	PRAGUE	armchair		59 cm	57 cm	78 cm	-	4,2 kg	Anthracite	Stackable	Aluminium pipe	Interior & exterior	060935					
CHANTILLY TOP 10	chair		47 cm	61 cm	94 cm	-	4 kg	White	Stackable	Aluminium pipe	Interior & exterior	064327		stool		57 cm	57 cm	113 cm	-	4,5 kg					060936					
GROOVE	stool		35 cm	35 cm	75 cm	-	8 kg	Black	-	Draff Steel	Interior	-	SAINT-GERMAIN	chair		42 cm	53 cm	90 cm	-	4 kg	Woven Black & White	Stackable	Aluminium frame & wicker (synthetic rattan)	Interior & exterior	084611					
			35 cm	35 cm	65 cm	-	7 kg							084612																
HARMONY	chair		49 cm	46 cm	81 cm	-	4 kg	Black beige White Green	Stackable	Polypropylene	Interior & exterior	084599 084701 084703 084702			Barchair		56,5 cm	53 cm	118 cm	-					6 kg					084614
HAVANA TOP 10	chair		59 cm	61 cm	83 cm	-	3,5 kg	Bamboo pipe	Stackable	Aluminium pipe	Interior & exterior	084560		STRASBOURG	armchair		57 cm	59 cm	79 cm	45 cm					3,2 kg	Woven Anthracite	Stackable	Aluminium pipe	Interior & exterior	055391
	armchair						3,8 kg	Beige rope				084561																		
KING	armchair		60 cm	54 cm	82 cm	45 cm	3,8 kg	White Chocolat Black Taupe	Stackable	Polypropylene	Interior & exterior	068107 058485 056106 055492				armchair		51,2 cm	51 cm	77,8 cm					-	3,75 kg	White Black Beige Grey Anthracite	Stackable	Aluminium pipe	Interior & exterior
KROMY	chair		46 cm	53 cm	80 cm	-	3,5 kg	White Green lemon Orange red	Stackable	Polypropylene	Interior & exterior	034183 034185 034187 034188			chair		57 cm	54 cm	84 cm	45 cm	4,2 kg	White Black Red Taupe	Stackable	Aluminium pipe	Interior & exterior	- 034438 - 048983				
KROMY 2	armchair		53 cm	62 cm	82 cm	45 cm	4 kg	White Cream Black	Stackable	Polypropylene	Interior & exterior	053999 053998 034242	TOKYO		chair		43 cm	48,5 cm	84 cm	45 cm	3,5 kg	Other colours on demand	Stackable	Aluminium pipe	Interior & exterior	058400				
	chair		44 cm	50 cm	81 cm	45 cm	3,3 kg																							
PALERME	armchair		59 cm	59 cm	82 cm	-	5 kg	Anthracite pipe Taupe rope Taupe cushion	Stackable	Aluminium pipe	Interior & exterior	060928			armchair		56 cm	55 cm	86 cm	66 cm	5,5 kg	Anthracite				Stackable	Aluminium pipe	Interior & exterior	046729	
PARIS TOP 10	armchair		56,5 cm	53 cm	90 cm	-	4,9 kg	White bamboo Moka bamboo	Stackable	Aluminium pipe	Interior & exterior	058914		TROCADERO	armchair		46 cm	53 cm	80 cm	-	3,5 kg	Black				Stackable	Polypropylene	Interior & exterior	058873	
	chair		42 cm	53 cm	90 cm	-	3,8 kg					058913			armchair		058874													
												058912																		
												058911	VINCENNES TOP 10		chair		49 cm	58 cm	88 cm	46 cm	4 kg	Black	Stackable	Aluminium pipe	Interior & exterior	064328				

W : width - D : depth - H : height - S : seat height - Wt: weight

74 - Werzalit 2023 Non contractual photographs. Colours may vary depending on manufacture.

> TOP 10 : Order directly and be delivered in record time with an order departure within 5 working days.

W : width - D : depth - H : height - S : seat height - Wt: weight

Werzalit 2023 - 75

TABLES & KITS

Aware of the challenges of your business, Werzalit deploys solutions to support you even further. We created ready-to-install kits. Solutions economical that meet your most urgent needs.



Shipping
in 72h



Establishment
simplified



Quick
installation

Kit n° 1 BISTRO

Gênes marble



Table top Ø 60
Gênes marble
with brass strapping and inserts



The **Tradition 3** Black base



2 **Paris Bamboo** moka chairs

What you need:



Kit n° 2 BISTRO 2

Gênes marble



Table top 70 x 70
Gênes marble
with inserts



Tradition 4 Black base



2 **Paris Bamboo** moka armchairs

What you need:



UNIVERSAL

UNIVERSAL TROLLEY
FOR BUILT-IN BASE
AND DROP-DOWN
TOPS

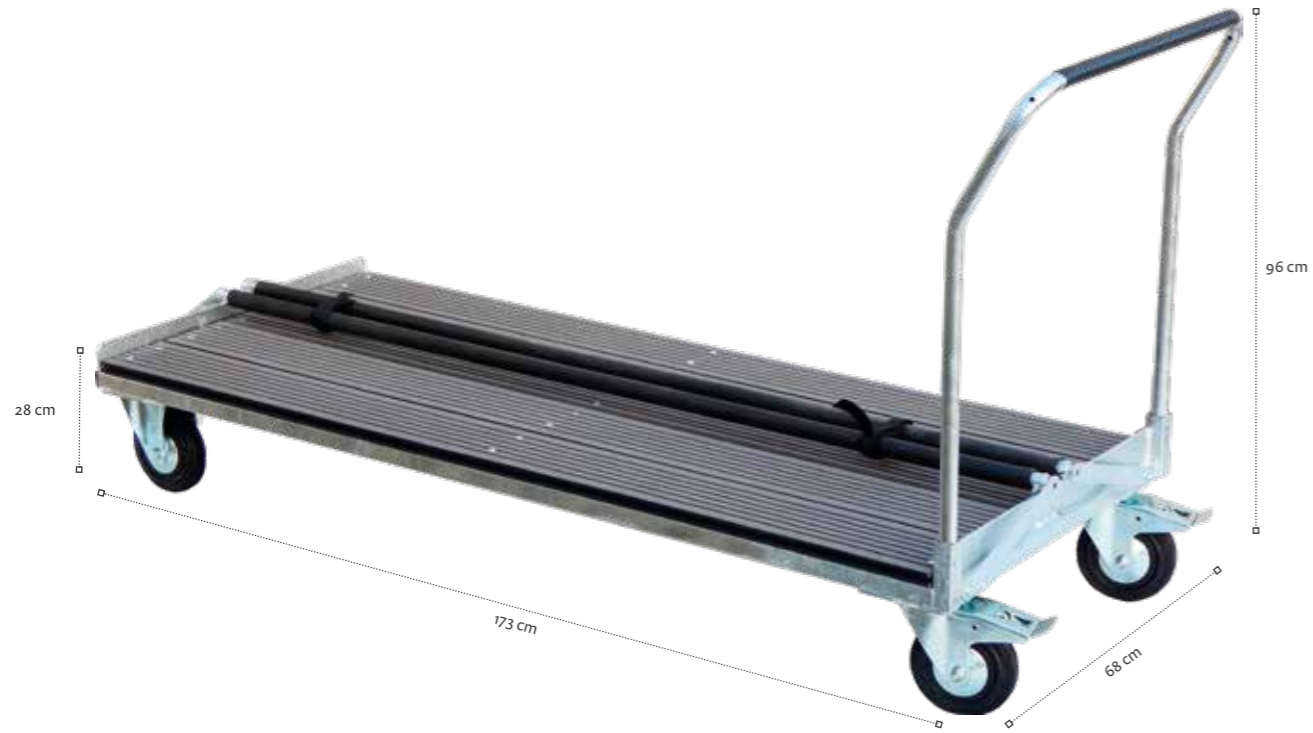

11 X AVANGARD



10 X BOOMRANG



8 X DELUXE



9 X REFLEX 3

POS



POS 5 TABLE TOPS



POS 10 TABLE TOPS



POS 20 TABLE TOPS



POS 40 TABLE TOPS

werzalit®
since 1923.

Beyond proudly claiming our status as a French manufacturer backed by a European group which is celebrating its 100th anniversary in 2023, WERZALIT® is a brand dedicated to the professional CHR sector (Cafés, Hotels, Restaurants) which shines throughout the world.

WERZALIT SAS is more than 60 years of passion and creativity in the manufacturing of moulded laminate table tops. It is also a large collection of quality products, neat finishes and constantly renewed styles, both for outdoor and indoor use.

It is also, thanks to a wide range of materials (HPL, imitation wood, solid wood, draff), table bases and chairs, that you can be assured of a practical and convivial table, with a focus on modernity, comfort and technical innovation.

Avenue des Bois Déroulés
17308 Rochefort-sur-Mer Cedex
France
Tél: +33 (0)5 46 82 15 40
commercial.fr@werzalit.com



www.werzalit.com

Ce document n'engage pas la responsabilité du fabricant qui se réserve le droit de modifier sans préavis les produits mentionnés. Photos non contractuelles. - This document does not bind manufacturer's responsibility. The manufacturer reserves the right to modify the aforementioned products without previous notice. Non contractual photographs. - Der Hersteller bewahrt sich das Recht, ohne vorherige Ankündigung seine erwähnten Produkte zu ändern. Photos nicht verpflichtend. - Este catálogo no responsabiliza al fabricante quien se reserva el derecho de modificar sin preaviso los productos mencionados. No son fotos contractuales. - Questo documento non obbliga la responsabilità del fabbricante che si riserva il diritto di modificare senza preavviso i prodotti menzionati. Foto non contrattuale.