

**VONDOM**

**CONTRACT**

# VONDOM

## COLLECTIONS

- 128 REVOLUTION
- 16 AFRICA
- 52 BROOKLYN
- 58 DELTA
- 98 FAZ
- 116 FAZ BAR
- 112 FRAME
- 114 FIESTA
- 122 GATSBY
- 28 IBIZA
- 72 KES
- 42 KIMONO
- 46 LOVE
- 108 MARI-SOL
- 120 MARQUIS
- 68 PEDRERA
- 34 QUARTZ
- 64 SABINAS
- 84 SOLID
- 88 SPRITZ
- 94 VASES
- 118 VELA
- 76 VOXEL
- 24 WALL STREET

## PRODUCT GUIDE CATEGORIES

- 128 REVOLUTION
- 144 CHAIRS
- 154 SOFA
- 156 STOOLS
- 159 SUN LOUNGERS
- 161 TABLES
- 178 COUNTERS
- 184 LAMPS
- 187 FINISHES

# MANTA

BY EUGENI QUITLLET

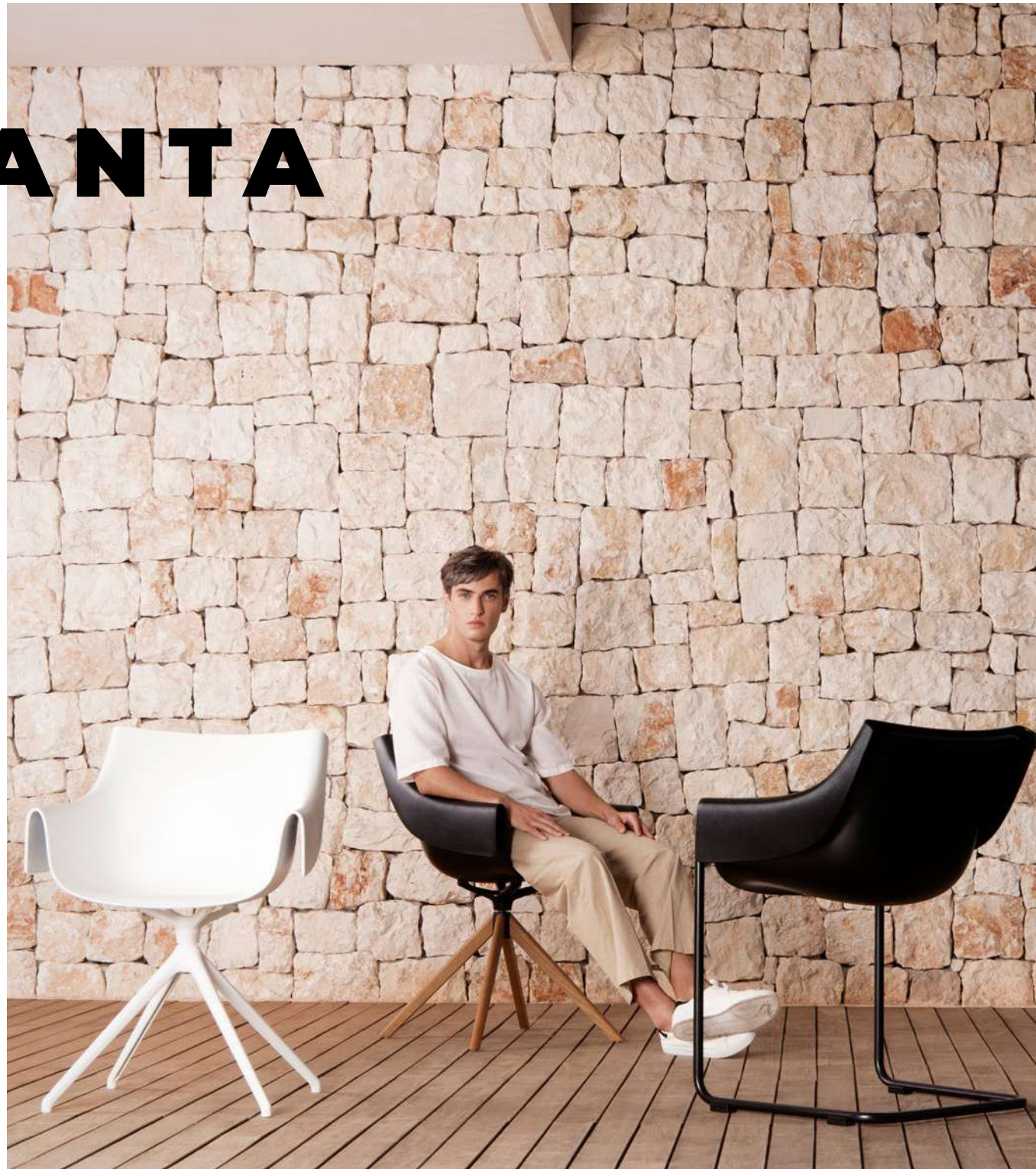

MANTA SWIVEL & SWIVEL WITH CASTERS & SWIVEL WOODEN LEGS & CANTILEVER & FRAME TABLE  
white & melon & black & ecru



MANTA **SWIVEL WOODEN LEGS & FRAME TABLE**  
wood 1 base + black seat & black base + hpl black



MANTA **SWIVEL & MARI-SOL TABLE**  
black base + white seat & white base + hpl white



MANTA **SWIVEL CHAIR & FRAME TABLE**  
black base + tortora seat & black base + hpl black



MANTA **CANTILEVER CHAIR & FRAME TABLE**  
black base + ecru seat & black base + hpl black

# INCASSO

BY ARCHIRIVOLTO DESIGN

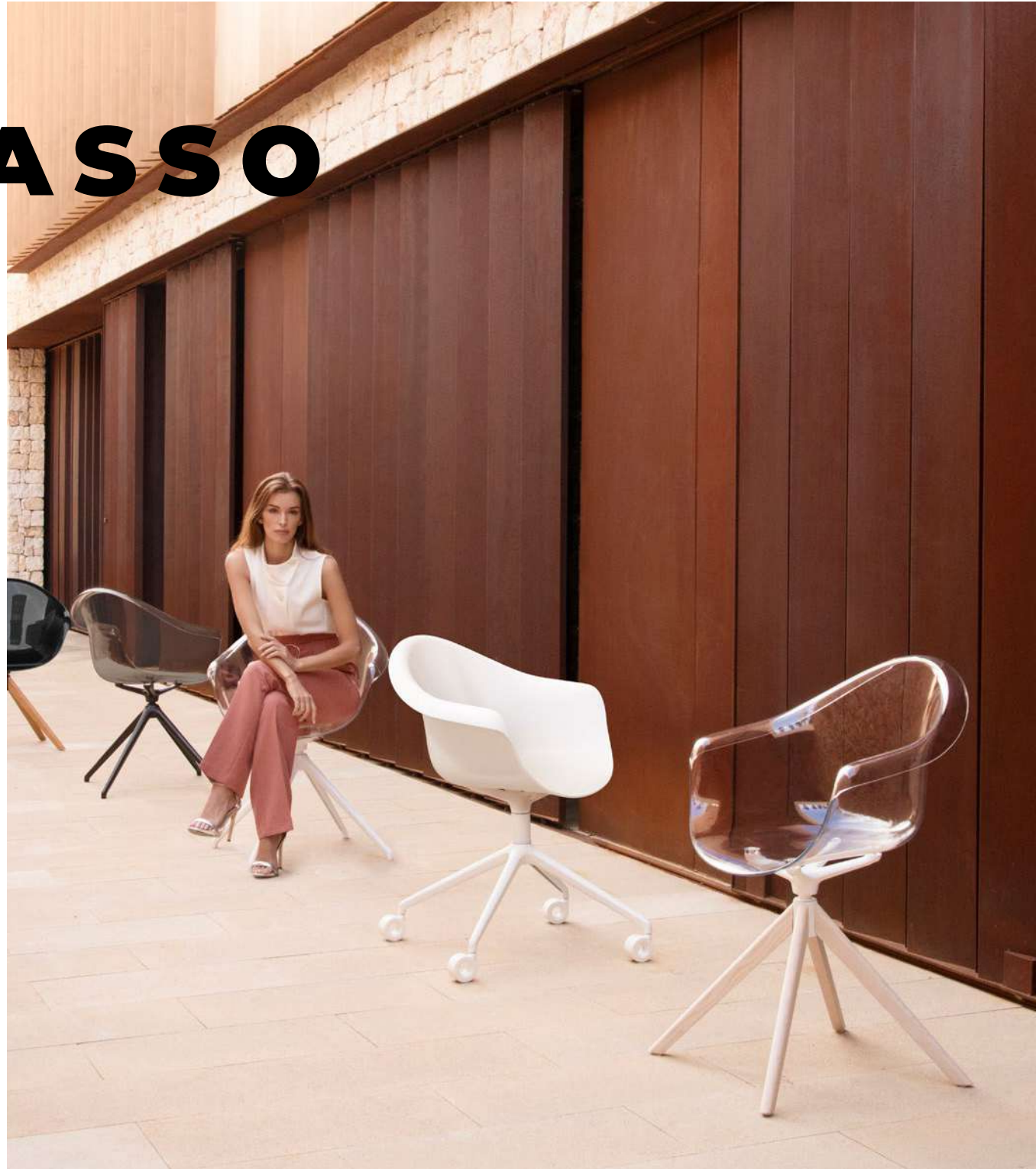

INCASSO **WOODEN SWIVEL CHAIR & SWIVEL CHAIR WITH CASTERS & SWIVEL CHAIR**  
opaque black & crystal & fume & opaque white & amber



INCASSO **SWIVEL CHAIR WITH CASTERS & FRAME TABLE**  
 white base + opaque white seat & white table base + white hpl top



INCASSO **SWIVEL CHAIR & MARI-SOL TABLE**  
 black base + crystal seat & black base + black hpl top



INCASSO **WOODEN SWIVEL CHAIR**  
wood 1 + black + ambar seat



INCASSO **WOODEN SWIVEL CHAIR & VELA TABLE**  
wood 2 base + opaque black seat & black base + black hpl top



# AFRICA

BY EUGENI QUITLET

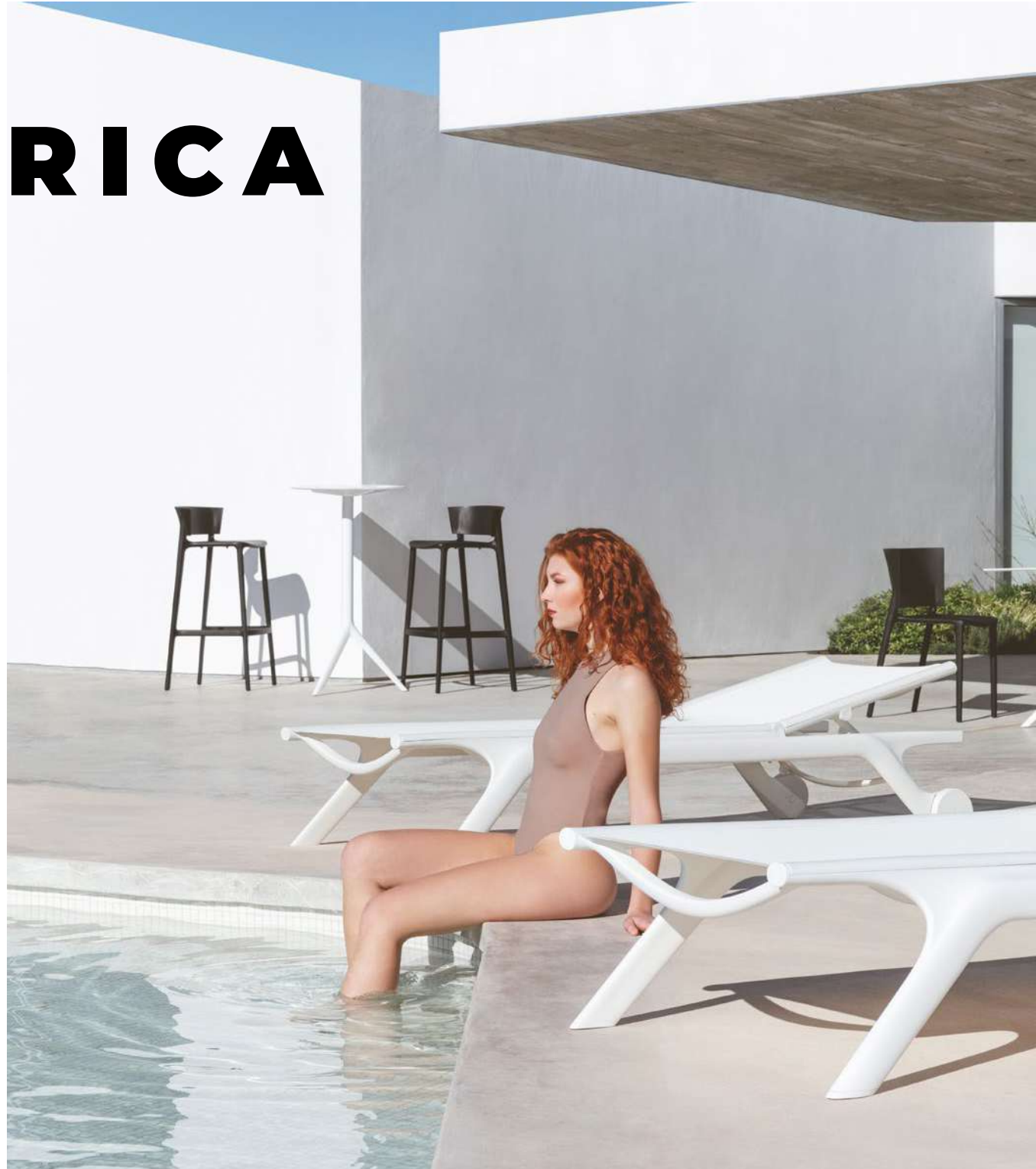

AFRICA **ARMCHAIR & CHAIR & STOOL & MARI-SOL TABLE**  
white & ecru



AFRICA **LOUNGE CHAIR** & MARI-SOL **TABLE D59S**  
 cream + duna 1009 + hpl solid core crema



AFRICA **LOUNGE CHAIR** & MARI-SOL **TABLE**  
 black + krollet 1921 & black



AFRICA **ARMCHAIR** & **MARI-SOL TABLE**  
white



AFRICA **SUN LOUNGER**  
white



# WALL STREET

BY EUGENI QUITLLET



WALL-STREET **ARMCHAIR** & MARI-SOL **TABLE**  
white



# IBIZA

BY EUGENI QUITLLET



IBIZA SUN LOUNGER & LOUNGE CHAIR & CHAIR  
 & ARMCHAIR & CHAIR WITH ARMS  
 milos & cala



reddot winner 2020



IBIZA LOUNGE CHAIR & SUN LOUNGER & MARI-SOL TABLE  
pickle & white



IBIZA SUN LOUNGER  
milos





# QUARTZ

BY RAMÓN ESTEVE



QUARTZ CHAIR & FOLDING CHAIR & CHAIR WITH ARMS  
white & black & bronze



QUARTZ **FOLDING CHAIR**  
black



Hotel  
QUARTZ **FOLDING CHAIR**  
black



QUARTZ **TABLE**  
white, ecru & black



Terrace  
QUARTZ **CHAIR & TABLE**  
black & white



QUARTZ **CHAIR & TABLE**  
black



Private House  
QUARTZ **CHAIR & FRAME TABLE & ULM DAYBED**  
white & lacq. white

# KIMONO

BY RAMÓN ESTEVE



KIMONO **CHAIR & FAZ TABLE**  
cristal & black



KIMONO CHAIR  
white & cristal



KIMONO CHAIR  
amber

# LOVE

BY EUGENI QUITLLET



LOVE CHAIR  
manta



reddot winner 2020





# LOVE MINI

BY EUGENI QUITLLET



LOVE **MINI CHAIR**  
melon & almond & navy

# BROOKLYN

BY EUGENI QUITLLET



BROOKLYN **CHAIR & STOOLS** & MARI-SOL **TABLE**  
black & black + glass top

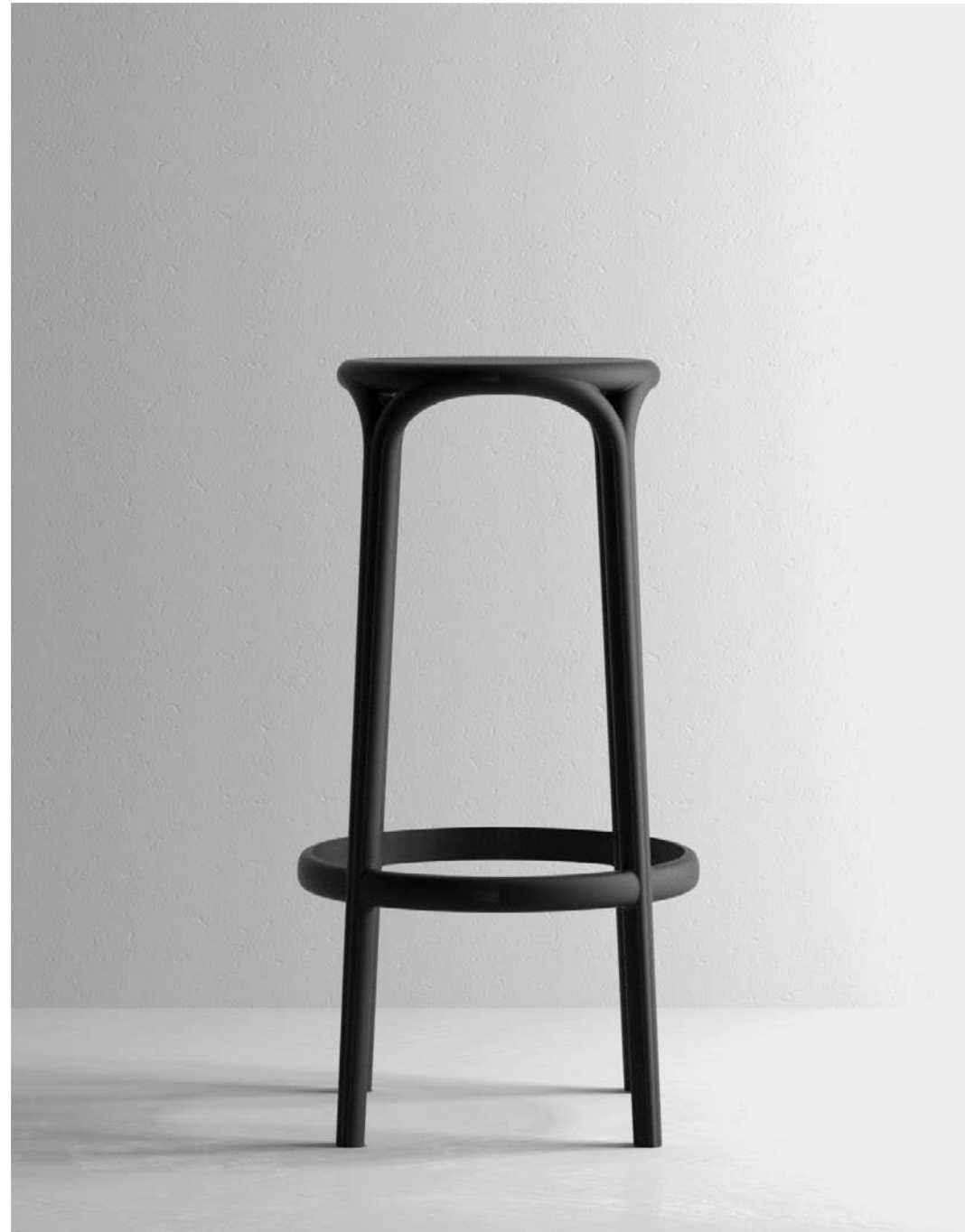

BROOKLYN **STOOL**  
black



BROOKLYN **STOOLS** & MARI-SOL **TABLE**  
black



# DELTA

BY JORGE PENSI



DELTA CHAIR & TABLE  
white & white base + solid core white



**DELTA TABLE**  
white + glass & black + black hpl & black hpl



**DELTA TABLE & CHAIR**  
white table base + glass top & white





# SABINAS

BY JAVIER MARISCAL



SABINAS **ARMCHAIR** & **MARI-SOL TABLE**  
red & black



# PEDRERA

BY EUGENI QUITLLET



Batel Auditorium, Spain  
PEDRERA **ARMCHAIR** & **MARI-SOL TABLE**  
red & white + glass top



# KES

BY GABRIELE + OSCAR BURATTI



KES CHAIR & CHAIR WITH ARMS & MARI-SOL TABLE  
white



# VOXEL

BY KARIM RASHID



VOXEL CHAIR  
red



VOXEL **STOOL & CHAIR** & **FAZ COUNTER** & **TABLE**  
black & lacquered black

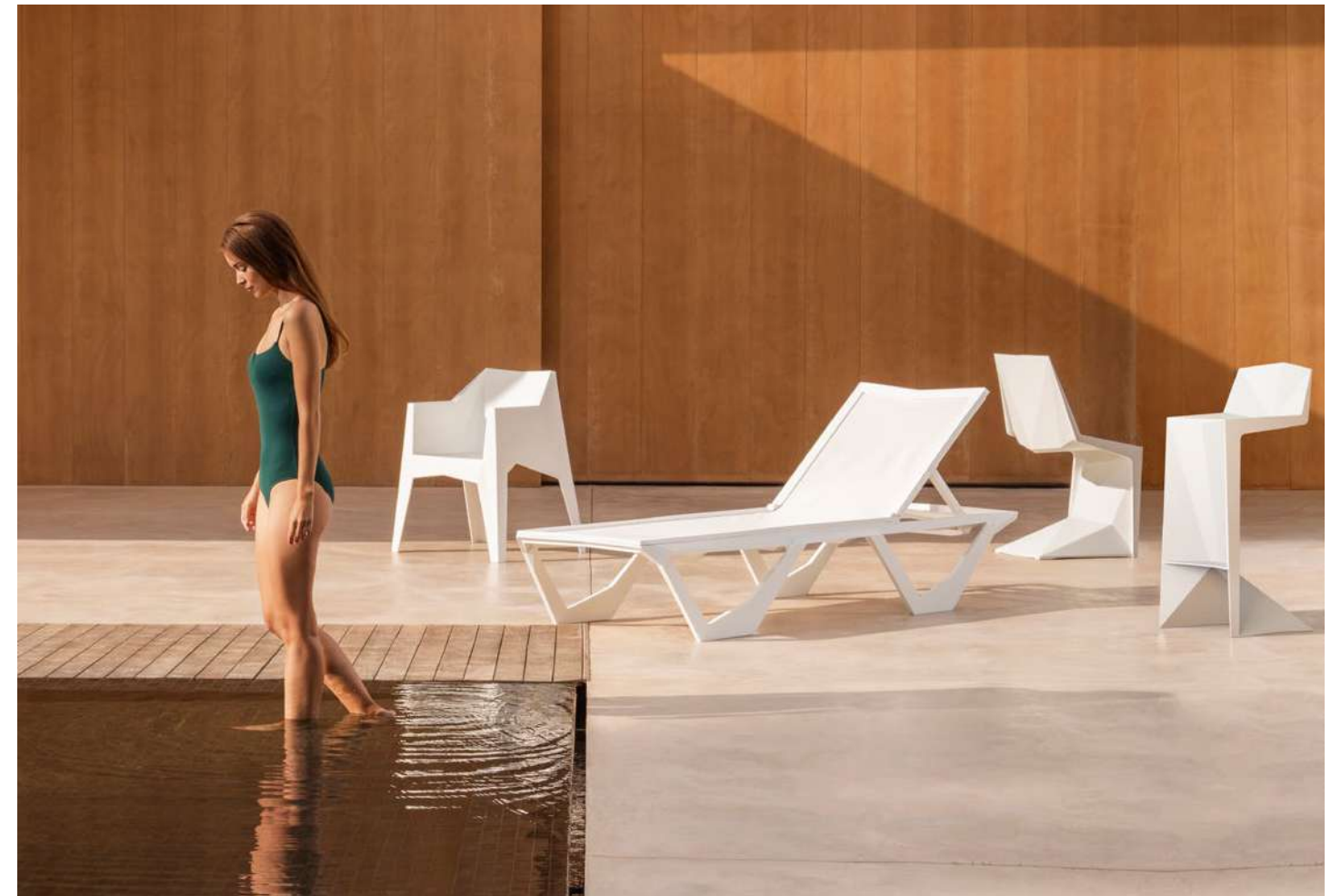

VOXEL **ARMCHAIR** & **SUN LOUNGER** & **CHAIR** & **STOOL**  
white





# VOXEL MINI

BY KARIM RASHID



VOXEL MINI CHAIR  
white, red and almond

# SOLID

BY STEFANO GIOVANNONI



SOLID **ARMCHAIR & CHAIR & TABLE**  
white



# SPRITZ

BY ARCHIRIVOLTO DESIGN



SPRITZ **SUN LOUNGER & LOW TABLE**  
ecru



SPRITZ **SOFA & LOUNGE CHAIR & COFFEE TABLE**  
white



SPRITZ **STOOL & TABLE**  
white



# VASES

BY ESTUDI{H}AC



VASES CHAIR & STOOL & MARI-SOL TABLE  
white





# FAZ

BY RAMÓN ESTEVE



FAZ CHAIR & ARMCHAIR & TABLE  
white & ecru



FAZ **CHAIR & ARMCHAIR & FRAME TABLE**  
black



Restaurant, Spain  
FAZ **CHAIR & TABLE**  
black & inox. legs



FAZ **STOOL & TABLE**  
black



FAZ **CHAIR & TABLE**  
black



FAZ WOOD **CHAIR & ARMCHAIR & TABLE**  
white + ash wood 2



FAZ WOOD **CHAIR & ARMCHAIR & STOOL & TABLE**  
black + ash wood 2



# MARI-SOL

BY EUGENI QUITLLET



AFRICA **ARMCHAIR** & MARI-SOL **TABLE**  
white





# FRAME

BY RAMÓN ESTEVE



FRAME **ARMCHAIR + DINING TABLE**  
ecru & lacquered white

# FIESTA

BY ARCHIRIVOLTO DESIGN

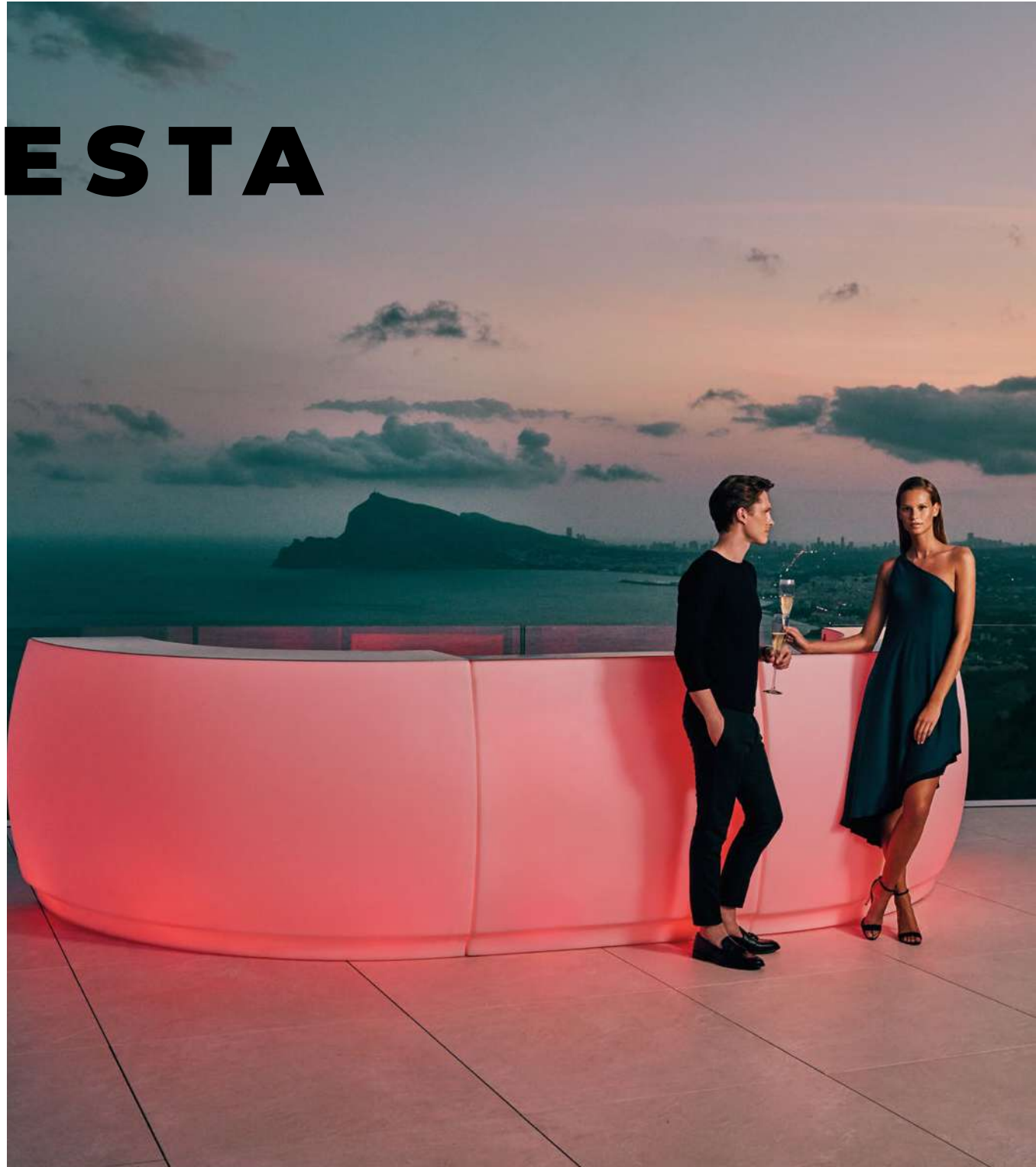

FIESTA COUNTER 120  
ice + rgbw



FIESTA COUNTER & MOMA STOOL  
ice

# FAZ

BY RAMÓN ESTEVE



Hotel hall  
**FAZ COUNTER & VERTEX STOOL & FAZ LAMP**  
 ice + rgbw

# VELA

BY RAMÓN ESTEVE

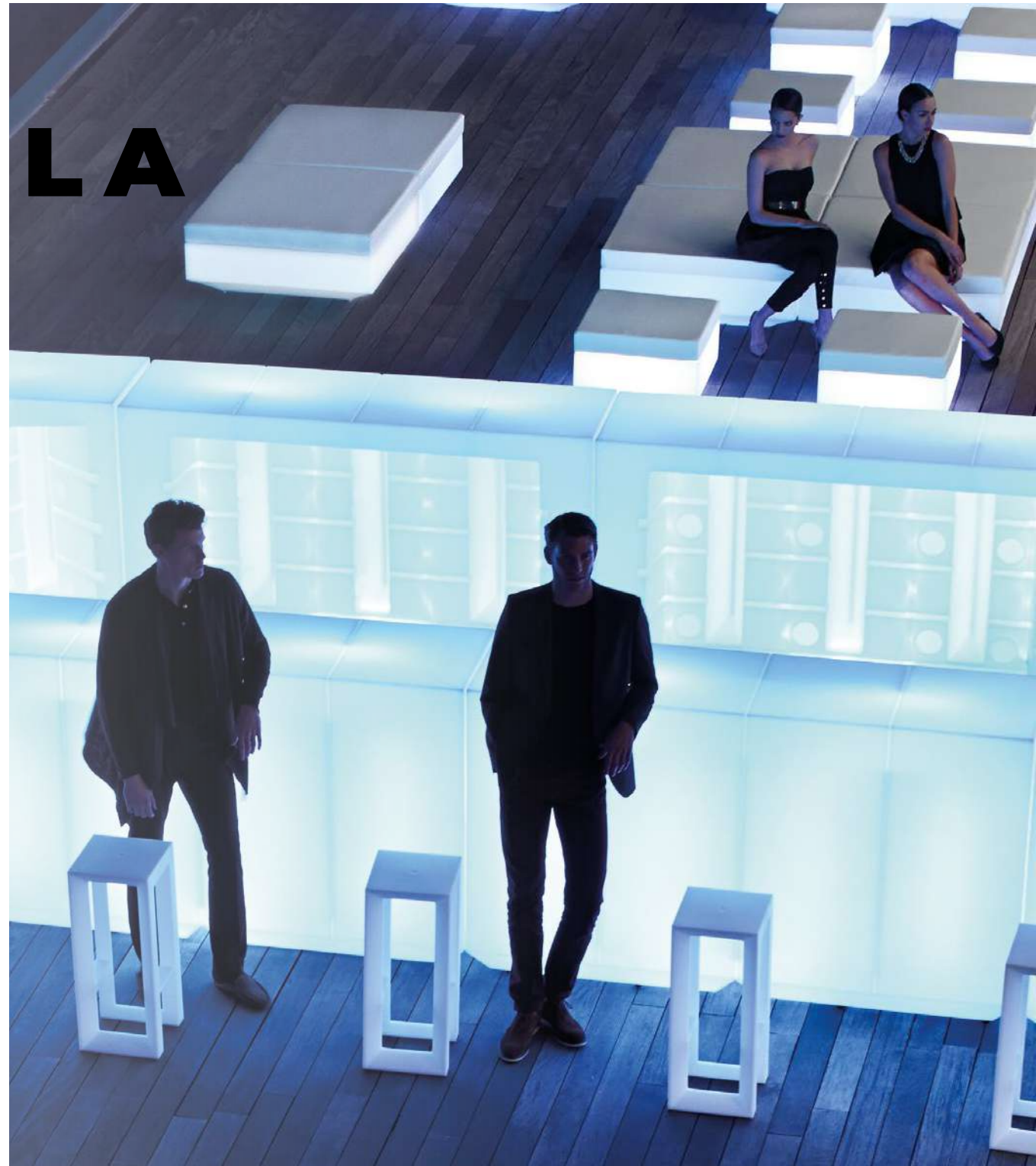

VELA **CATERING COUNTER**  
white + glass top + ice-bucket

# MARQUIS

BY ESTUDI{H}AC



MARQUIS **TABLE LAMP**  
clear

# GATSBY

BY RAMÓN ESTEVE

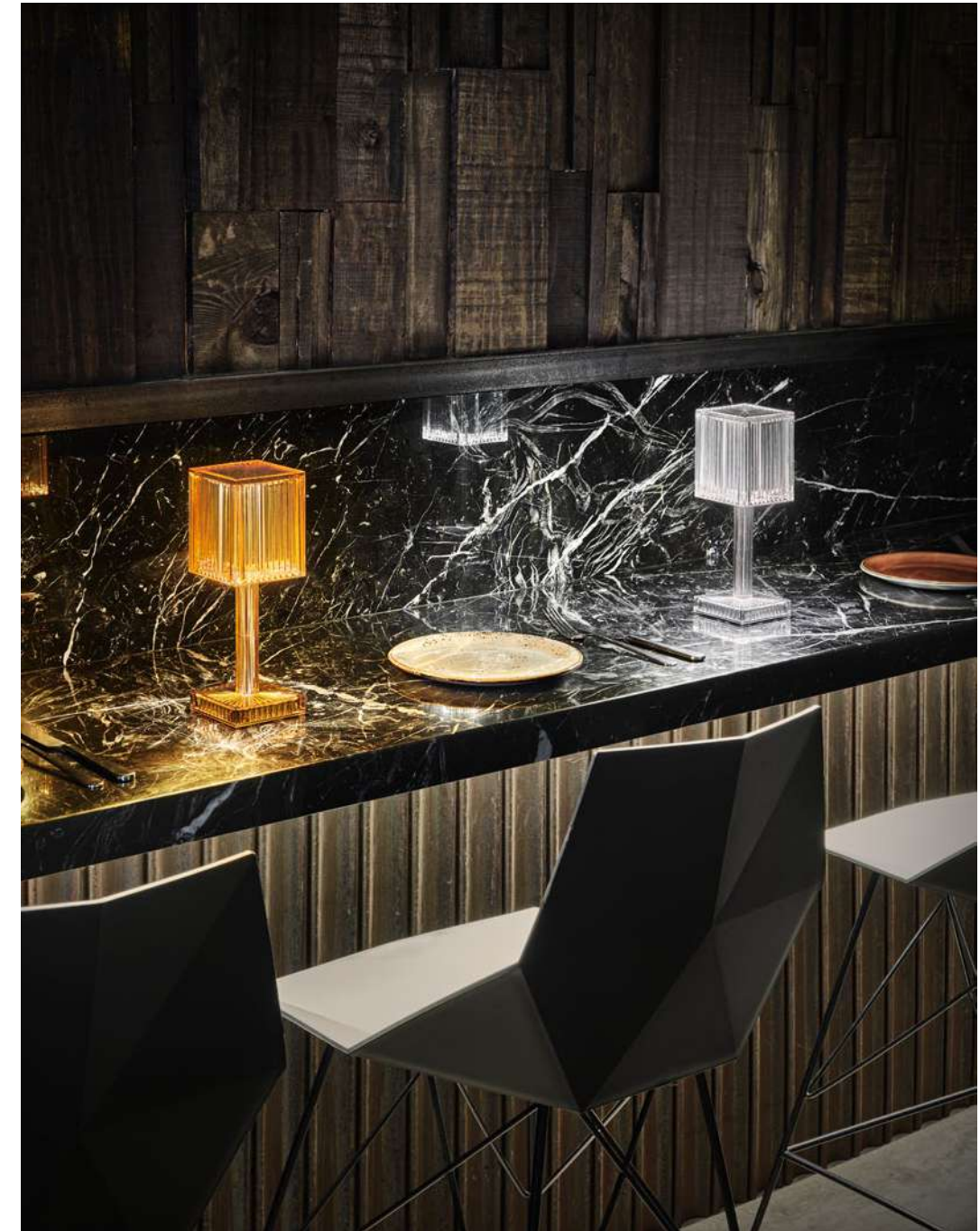

GATSBY **PRISM TABLE LAMP** & **FAZ STOOL**  
ambar & clear & black



GATSBY **CYLINDRICAL TABLE LAMP** & FAZ **CHAIR & TABLE**  
clear & ecru & black



reddot winner 2020



GATSBY **PRISM TABLE LAMP**  
ambar & clear & black

# REVOLUTION

Collections manufactured by recovering and recycling plastics from the Mediterranean



IBIZA  
BY EUGENI QUITLLET



This is the first collection we launched by recovering and manufacturing recycled fishing nets from the Mediterranean Sea. Eugeni Quitllet was inspired by the idyllic natural surroundings of Ibiza, where he spent his childhood, to design a unique Mediterranean inspired collection. Wave shaped liked pieces that also simulate seashells.



BY EUGENI QUITLET  
**BROOKLYN**



The Brooklyn Chair is available in three Revolution colours: Milos, Cala and Manta. We obtain Manta colour from recollecting and processing fishing nets from Mediterranean fishermen and transforming them into durable and recyclable products.



EVOLUTION



The Revolution's white is called Milos (on the right photo) and it is the result of transforming recycled plastics from our Mediterranean coasts. Our designs are created with a soul.



BY EUGENI QUITLLET  
**LOVE**



Cala (on the right photo) is a bright but also warm colour obtained from processing plastics from the Balearic Islands and transforming them into lasting and recyclable products.

BY EUGENI QUITLET  
**PEDRERA**



In our VONDOM Revolution range, we manufacture our products using recycled plastic from the Mediterranean Sea, extending it's life and enhancing it's real value. Due to the origin of this raw material slight natural imperfections may appear, which gives every piece it's own personality and spirit.

EVOLUTION

# PRICE LIST & **FEATURES**

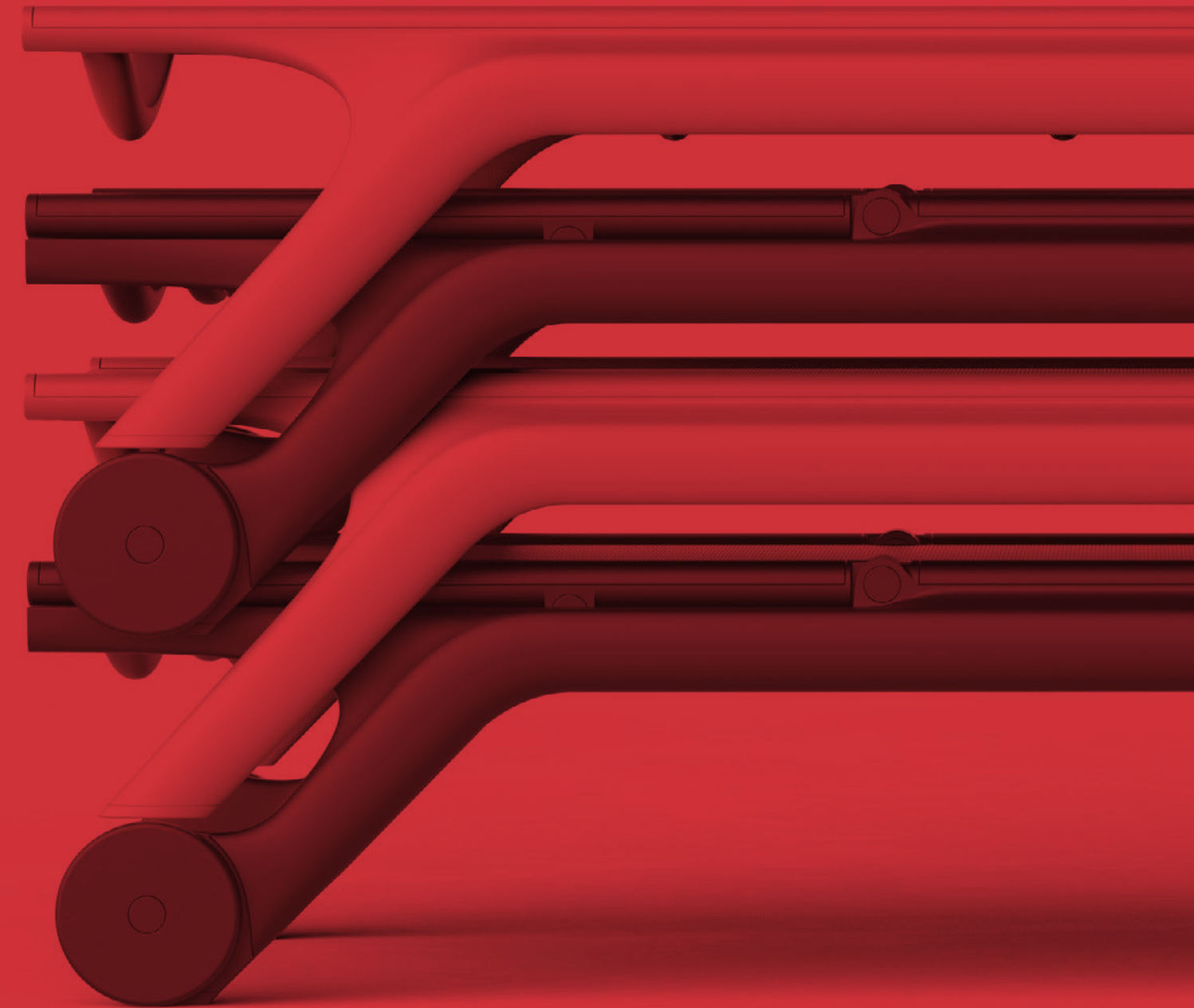



Seat colour  
Color de asiento

Metal Colour  
Color del metal

Wood  
Madera

Packaging  
Embalaje

MANTA cantilever armchair.



- WHITE
- BLACK
- ECRU
- TORTORA
- MELON

2 uds. 22,4 kg 0,32 m<sup>3</sup>  
2 uds. 49,4 lb 11,2 ft<sup>3</sup>

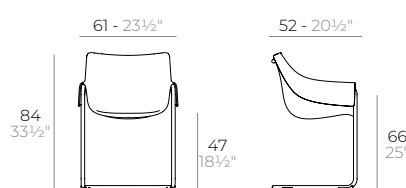

Seat colour  
Color de asiento

Metal Colour  
Color del metal

Wood  
Madera

Packaging  
Embalaje

INCASSO armchair.



- GLOSS WHITE
- GLOSS BLACK
- CLEAR CRISTAL
- CLEAR AMBAR
- CLEAR FUME

2 uds. 0 kg 0,32 m<sup>3</sup>  
2 uds. 0 lb 11,2 ft<sup>3</sup>

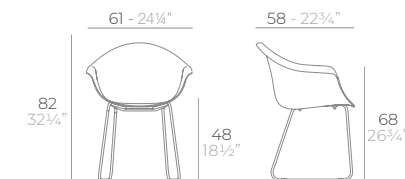

MANTA swivel armchair.



- WHITE
- BLACK
- ECRU
- TORTORA
- MELON

2 uds. 17,2 kg 0,33 m<sup>3</sup>  
2 uds. 38 lb 11,8 ft<sup>3</sup>

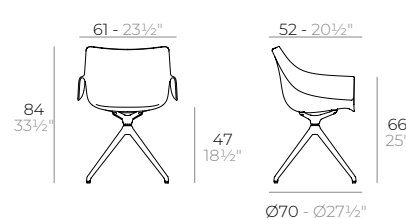

INCASSO swivel armchair.



- GLOSS WHITE
- GLOSS BLACK
- CLEAR CRISTAL
- CLEAR AMBAR
- CLEAR FUME

2 uds. 17,2 kg 0,14 m<sup>3</sup>  
2 uds. 38 lb 5 ft<sup>3</sup>

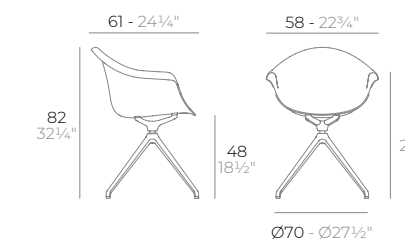

MANTA swivel armchair with caster.



- WHITE
- BLACK
- ECRU
- TORTORA
- MELON

2 uds. 15,1 kg 0,33 m<sup>3</sup>  
2 uds. 33,2 lb 11,8 ft<sup>3</sup>

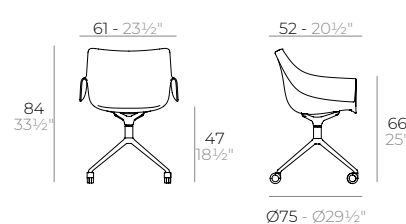

INCASSO swivel armchair with caster.



- GLOSS WHITE
- GLOSS BLACK
- CLEAR CRISTAL
- CLEAR AMBAR
- CLEAR FUME

2 uds. 15,1 kg 0,14 m<sup>3</sup>  
2 uds. 33,2 lb 5 ft<sup>3</sup>

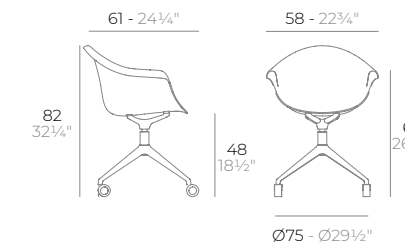

MANTA swivel armchair with wooden legs.



- WHITE
- BLACK
- ECRU
- TORTORA
- MELON
- WOOD 1
- WOOD 2

2 uds. 18,6 kg 0,33 m<sup>3</sup>  
2 uds. 41 lb 11,8 ft<sup>3</sup>

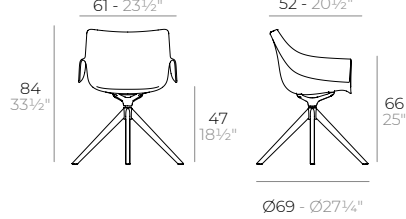

INCASSO swivel armchair with wooden legs.



- GLOSS WHITE
- GLOSS BLACK
- CLEAR CRISTAL
- CLEAR AMBAR
- CLEAR FUME
- WHITE
- BLACK
- WOOD 1
- WOOD 2

2 uds. 18,6 kg 0,14 m<sup>3</sup>  
2 uds. 41 lb 5 ft<sup>3</sup>

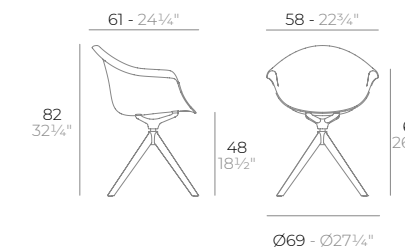

## AFRICA armchair.



Basic. Básico.  
**REVOLUTION**  
Recycled plastic from the Mediterranean\*

Lacquered. Lacado.



- |        |             |
|--------|-------------|
| WHITE  | LACQ. WHITE |
| BLACK  | LACQ. BLACK |
| ECRU   | LACQ. RED   |
| RED    | LACQ. ANTH. |
| BRONZE | MILOS (R)   |
| PICKLE | CALA (R)    |
| NAVY   | MANTA (R)   |

4 uds. 28,6 kg 0,42 m<sup>3</sup>  
4 uds. 63 lb 14,7 ft<sup>3</sup>

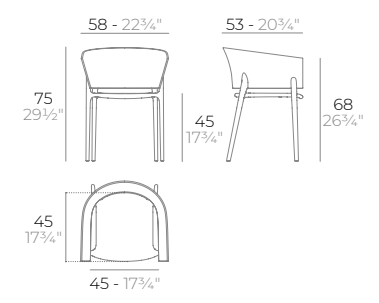

## AFRICA chair.



Basic. Básico.  
**REVOLUTION**  
Recycled plastic from the Mediterranean\*

Lacquered. Lacado.



- |        |             |
|--------|-------------|
| WHITE  | LACQ. WHITE |
| BLACK  | LACQ. BLACK |
| ECRU   | LACQ. RED   |
| RED    | LACQ. ANTH. |
| BRONZE | MILOS (R)   |
| PICKLE | CALA (R)    |
| NAVY   | MANTA (R)   |

4 uds. 18,5 kg 0,36 m<sup>3</sup>  
4 uds. 40,8 lb 12,7 ft<sup>3</sup>

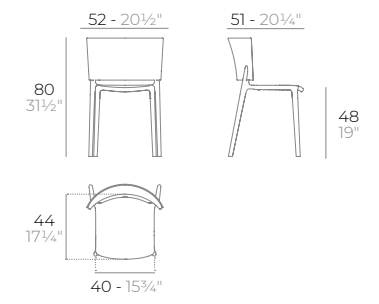

## AFRICA lounge chair.



Basic. Básico.  
**REVOLUTION**  
Recycled plastic from the Mediterranean\*

Lacquered. Lacado.

FABRICS

- Group 1 AB
- Group 1 C
- Group 2



- |            |                  |
|------------|------------------|
| WHITE      | LACQ. WHITE      |
| BLACK      | LACQ. BLACK      |
| ECRU       | LACQ. ANTH.      |
| PURJAI RED | LACQ. PURJAI RED |
| CREMA      | LACQ. CREMA      |
| MODO GREEN | LACQ. MODO GREEN |
| NOTTE BLUE | LACQ. NOTTE BLUE |

2 uds. 20,1 kg 0,63 m<sup>3</sup>  
2 uds. 44,2 lb 22,3 ft<sup>3</sup>

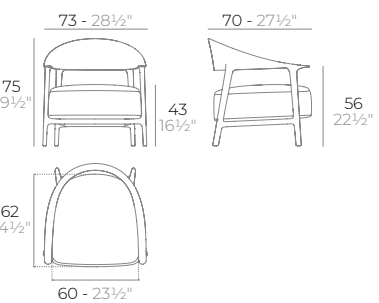

## DELTA chair with arms.



Basic. Básico.  
**REVOLUTION**  
Recycled plastic from the Mediterranean\*

Lacquered. Lacado.



- |        |             |
|--------|-------------|
| WHITE  | LACQ. WHITE |
| BLACK  | LACQ. BLACK |
| ECRU   | LACQ. RED   |
| RED    | LACQ. ANTH. |
| BRONZE |             |

4 uds. 16 kg 0,4 m<sup>3</sup>  
4 uds. 35,3 lb 14,1 ft<sup>3</sup>

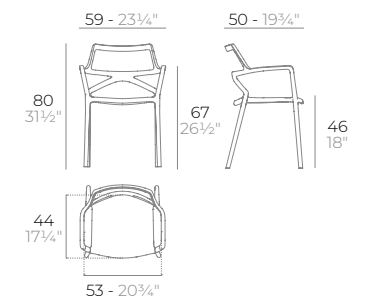

## IBIZA chair



Basic. Básico.  
**REVOLUTION**  
Recycled plastic from the Mediterranean\*



- |        |           |
|--------|-----------|
| WHITE  | MILOS (R) |
| BLACK  | CALA (R)  |
| ECRU   | MANTA (R) |
| PICKLE |           |

4 uds. 23,7 kg 0,32 m<sup>3</sup>  
4 uds. 52,2 lb 11,2 ft<sup>3</sup>

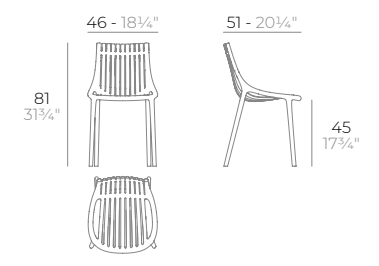

## IBIZA armchair



Basic. Básico.  
**REVOLUTION**  
Recycled plastic from the Mediterranean\*



- |        |           |
|--------|-----------|
| WHITE  | MILOS (R) |
| BLACK  | CALA (R)  |
| ECRU   | MANTA (R) |
| PICKLE |           |

4 uds. 25,7 kg 0,51 m<sup>3</sup>  
4 uds. 56,8 lb 17,9 ft<sup>3</sup>

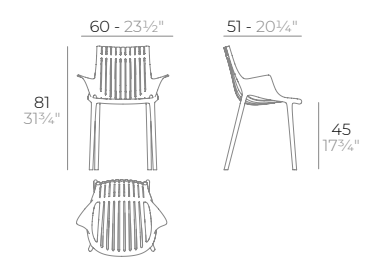

## IBIZA chair with arms



Basic. Básico.  
**REVOLUTION**  
Recycled plastic from the Mediterranean\*



- |        |           |
|--------|-----------|
| WHITE  | MILOS (R) |
| BLACK  | CALA (R)  |
| ECRU   | MANTA (R) |
| PICKLE |           |

4 uds. 25,3 kg 0,38 m<sup>3</sup>  
4 uds. 55,7 lb 13,6 ft<sup>3</sup>

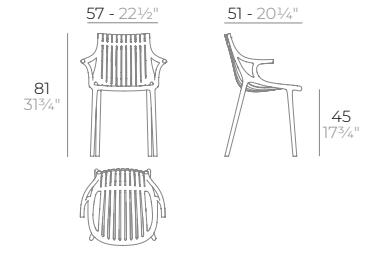

## IBIZA lounge chair



Basic. Básico.  
**REVOLUTION**  
Recycled plastic from the Mediterranean\*



- |        |           |
|--------|-----------|
| WHITE  | MILOS (R) |
| BLACK  | CALA (R)  |
| ECRU   | MANTA (R) |
| PICKLE |           |

4 uds. 38,7 kg 0,93 m<sup>3</sup>  
4 uds. 85,3 lb 32,7 ft<sup>3</sup>

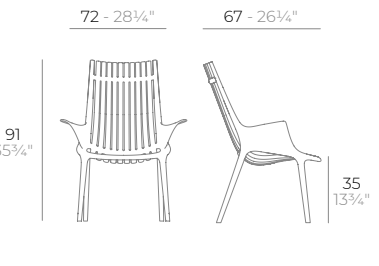

\*In our VONDOM Revolution range, we manufacture our products using recycled plastic, from the Mediterranean, extending it's life and enhancing it's real value. Due to the origin of this raw material slight natural imperfections may appear, which gives every piece it's own personality and spirit. \*En las colecciones de VONDOM Revolution trabajamos con plástico reciclado del mar Mediterráneo, alargamos su vida y potenciamos su valor. El origen de esta materia prima puede causar ligeras imperfecciones naturales que dotan a las piezas de una personalidad y espíritu propios.

**BROOKLYN** chair.



Basic. Básico.

**EVOLUTION**  
Recycled plastic from the Mediterranean\*

Lacquered. Lacado.



- |                                  |                                      |
|----------------------------------|--------------------------------------|
| <input type="checkbox"/> WHITE   | <input type="checkbox"/> LACQ. WHITE |
| <input type="checkbox"/> BLACK   | <input type="checkbox"/> LACQ. BLACK |
| <input type="checkbox"/> ECRU    | <input type="checkbox"/> LACQ. ANTH. |
| <input type="checkbox"/> TORTORA | <input type="checkbox"/> MILOS (R)   |
| <input type="checkbox"/> PICKLE  | <input type="checkbox"/> CALA (R)    |
|                                  | <input type="checkbox"/> MANTA (R)   |

4 uds. 18,6 kg 0,36 m<sup>3</sup>

4 uds. 40,9 lb 12,6 ft<sup>3</sup>

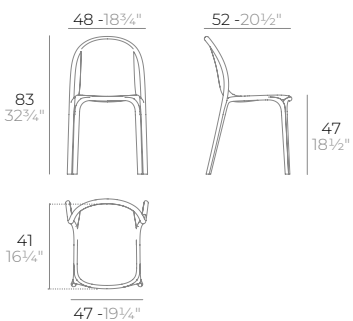

**FAZ CLEAR LEGS** chair.



Basic. Básico.

Lacquered. Lacado.



- |                                 |                                      |
|---------------------------------|--------------------------------------|
| <input type="checkbox"/> WHITE  | <input type="checkbox"/> LACQ. WHITE |
| <input type="checkbox"/> BLACK  | <input type="checkbox"/> LACQ. BLACK |
| <input type="checkbox"/> ECRU   | <input type="checkbox"/> LACQ. RED   |
| <input type="checkbox"/> RED    | <input type="checkbox"/> LACQ. ANTH. |
| <input type="checkbox"/> BRONZE |                                      |

4 uds. 15,2 kg 0,2 m<sup>3</sup>

4 uds. 33,5 lb 6,9 ft<sup>3</sup>

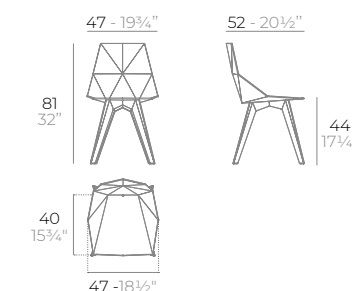

**BROOKLYN** chair with arms.



Basic. Básico.

**EVOLUTION**  
Recycled plastic from the Mediterranean\*

Lacquered. Lacado.



- |                                  |                                      |
|----------------------------------|--------------------------------------|
| <input type="checkbox"/> WHITE   | <input type="checkbox"/> LACQ. WHITE |
| <input type="checkbox"/> BLACK   | <input type="checkbox"/> LACQ. BLACK |
| <input type="checkbox"/> ECRU    | <input type="checkbox"/> LACQ. ANTH. |
| <input type="checkbox"/> TORTORA | <input type="checkbox"/> MILOS (R)   |
| <input type="checkbox"/> PICKLE  | <input type="checkbox"/> CALA (R)    |
|                                  | <input type="checkbox"/> MANTA (R)   |

4 uds. 23,1 kg 0,43 m<sup>3</sup>

4 uds. 50,8 lb 15,3 ft<sup>3</sup>

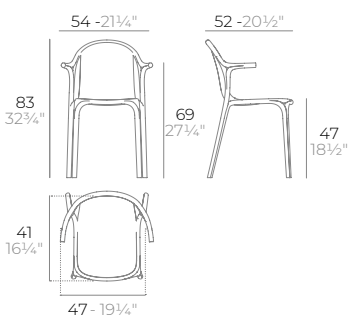

**FAZ CLEAR LEGS** armchair.



Basic. Básico.

Lacquered. Lacado.



- |                                 |                                      |
|---------------------------------|--------------------------------------|
| <input type="checkbox"/> WHITE  | <input type="checkbox"/> LACQ. WHITE |
| <input type="checkbox"/> BLACK  | <input type="checkbox"/> LACQ. BLACK |
| <input type="checkbox"/> ECRU   | <input type="checkbox"/> LACQ. RED   |
| <input type="checkbox"/> RED    | <input type="checkbox"/> LACQ. ANTH. |
| <input type="checkbox"/> BRONZE |                                      |

4 uds. 17,2 kg 0,27 m<sup>3</sup>

4 uds. 37,9 lb 9,7 ft<sup>3</sup>

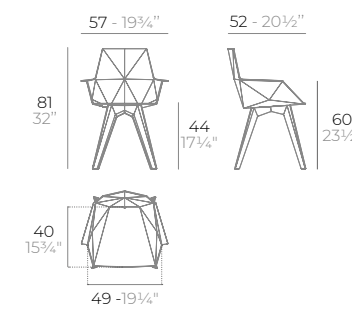

**LOVE** chair.



Basic. Básico.

**EVOLUTION**  
Recycled plastic from the Mediterranean\*

Lacquered. Lacado.



- |                                 |                                      |
|---------------------------------|--------------------------------------|
| <input type="checkbox"/> WHITE  | <input type="checkbox"/> LACQ. WHITE |
| <input type="checkbox"/> BLACK  | <input type="checkbox"/> LACQ. BLACK |
| <input type="checkbox"/> ECRU   | <input type="checkbox"/> LACQ. RED   |
| <input type="checkbox"/> RED    | <input type="checkbox"/> LACQ. ANTH. |
| <input type="checkbox"/> MELON  | <input type="checkbox"/> MILOS (R)   |
| <input type="checkbox"/> ALMOND | <input type="checkbox"/> CALA (R)    |
| <input type="checkbox"/> NAVY   | <input type="checkbox"/> MANTA (R)   |

4 uds. 20,9 kg 0,38 m<sup>3</sup>

4 uds. 46 lb 13,4 ft<sup>3</sup>

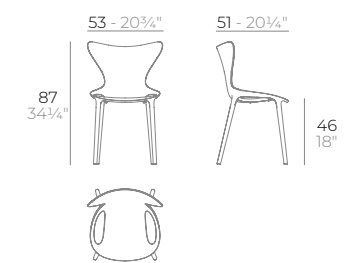

**FAZ INOX. LEGS** chair.



Basic. Básico.

Lacquered. Lacado.



- |                                |                                      |
|--------------------------------|--------------------------------------|
| <input type="checkbox"/> WHITE | <input type="checkbox"/> LACQ. WHITE |
| <input type="checkbox"/> BLACK | <input type="checkbox"/> LACQ. BLACK |
| <input type="checkbox"/> ECRU  | <input type="checkbox"/> LACQ. ANTH. |

- |                                |
|--------------------------------|
| <input type="checkbox"/> WHITE |
| <input type="checkbox"/> BLACK |
| <input type="checkbox"/> ECRU  |

4 uds. 18 kg 0,22 m<sup>3</sup>

4 uds. 39,7 lb 7,9 ft<sup>3</sup>

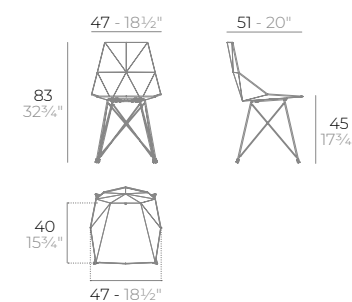

**LOVE** mini chair.



Basic. Básico.

Lacquered. Lacado.



- |                                 |                                      |
|---------------------------------|--------------------------------------|
| <input type="checkbox"/> WHITE  | <input type="checkbox"/> LACQ. WHITE |
| <input type="checkbox"/> BLACK  | <input type="checkbox"/> LACQ. BLACK |
| <input type="checkbox"/> ECRU   | <input type="checkbox"/> LACQ. RED   |
| <input type="checkbox"/> RED    | <input type="checkbox"/> LACQ. ANTH. |
| <input type="checkbox"/> MELON  | <input type="checkbox"/> MILOS (R)   |
| <input type="checkbox"/> ALMOND | <input type="checkbox"/> CALA (R)    |
| <input type="checkbox"/> NAVY   | <input type="checkbox"/> MANTA (R)   |

4 uds. 11,4 kg 0,19 m<sup>3</sup>

4 uds. 25,2 lb 6,9 ft<sup>3</sup>

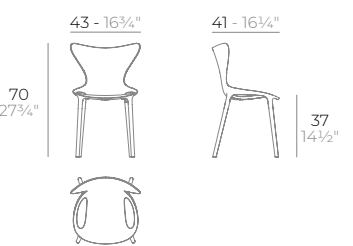

**FAZ INOX. LEGS** armchair.



Basic. Básico.

Lacquered. Lacado.



- |                                |                                      |
|--------------------------------|--------------------------------------|
| <input type="checkbox"/> WHITE | <input type="checkbox"/> LACQ. WHITE |
| <input type="checkbox"/> BLACK | <input type="checkbox"/> LACQ. BLACK |
| <input type="checkbox"/> ECRU  | <input type="checkbox"/> LACQ. ANTH. |

- |                                |
|--------------------------------|
| <input type="checkbox"/> WHITE |
| <input type="checkbox"/> BLACK |
| <input type="checkbox"/> ECRU  |

4 uds. 20 kg 0,27 m<sup>3</sup>

4 uds. 44,1 lb 9,7 ft<sup>3</sup>

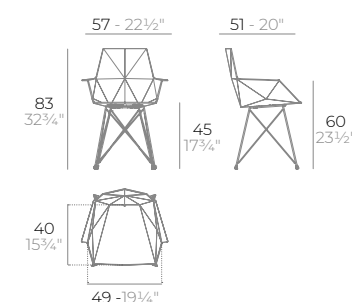

\*In our VONDOM Revolution range, we manufacture our products using recycled plastic, from the Mediterranean, extending it's life and enhancing it's real value. Due to the origin of this raw material slight natural imperfections may appear, which gives every piece it's own personality and spirit.  
\*En las colecciones de VONDOM Revolution trabajamos con plástico reciclado del mar Mediterráneo, alargamos su vida y potenciamos su valor. El origen de esta materia prima puede causar ligeras imperfecciones naturales que dotan a las piezas de una personalidad y espíritu propios.

FAZ WOOD chair.



Basic. Básico.

Lacquered. Lacado.

- WHITE
- BLACK
- ECRU
- LACQ. WHITE
- LACQ. BLACK
- LACQ. ANTH.

- WHITE
- BLACK

- WOOD 1
- WOOD 2

4 uds. 15,2 kg 0,27 m<sup>3</sup>

4 uds. 33,5 lb 9,4 ft<sup>3</sup>

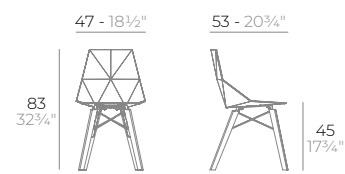

FAZ WOOD armchair.



Basic. Básico.

Lacquered. Lacado.

- WHITE
- BLACK
- ECRU
- LACQ. WHITE
- LACQ. BLACK
- LACQ. ANTH.

- WHITE
- BLACK

- WOOD 1
- WOOD 2

4 uds. 21,6 kg 0,39 m<sup>3</sup>

4 uds. 47,5 lb 13,6 ft<sup>3</sup>

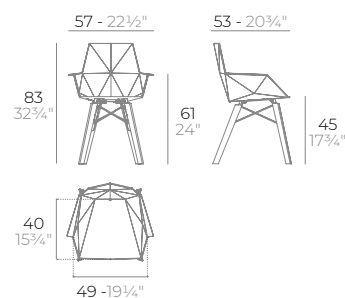

VASES armchair.



Basic. Básico.

Lacquered. Lacado.

- WHITE
- BLACK
- ECRU
- RED
- BRONZE
- LACQ. WHITE
- LACQ. BLACK
- LACQ. RED
- LACQ. ANTH.

- WHITE
- BLACK
- ECRU
- RED
- BRONZE

4 uds. 16,4 kg 0,52 m<sup>3</sup>

4 uds. 36,2 lb 18,5 ft<sup>3</sup>

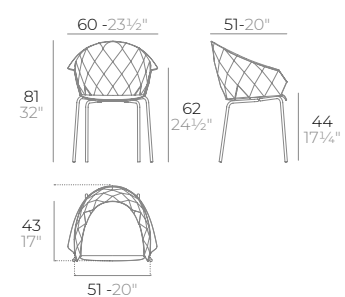

SABINAS armchair.



Basic. Básico.

Lacquered. Lacado.

- WHITE
- BLACK
- ECRU
- RED
- NAVY
- LACQ. WHITE
- LACQ. BLACK
- LACQ. ANTH.
- LACQ. RED

- LACQ. WHITE
- LACQ. BLACK
- LACQ. ANTH.
- LACQ. RED

4 uds. 20,2 kg 0,47 m<sup>3</sup>

4 uds. 44,4 lb 16,6 ft<sup>3</sup>

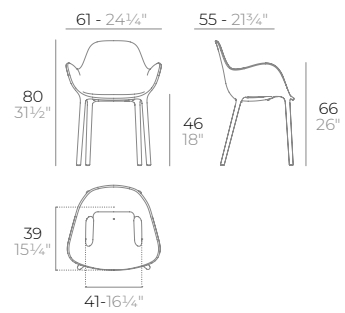

LA PEDRERA armchair.



Basic. Básico.

REVOLUTION  
Recycled plastic from the Mediterranean\*

Lacquered. Lacado.

- WHITE
- BLACK
- ECRU
- RED
- ALMOND

- LACQ. WHITE
- LACQ. BLACK
- LACQ. RED
- LACQ. ANTH.
- MILOS (R)
- CALA (R)
- MANTA (R)

4 uds. 28,6 kg 0,47 m<sup>3</sup>

4 uds. 63 lb 16,7 ft<sup>3</sup>

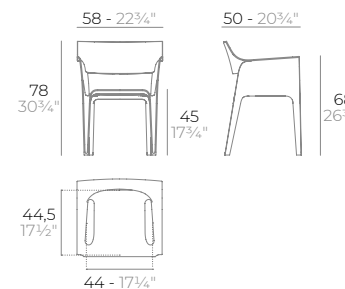

VOXEL armchair.



Basic. Básico.

Lacquered. Lacado.

- WHITE
- BLACK
- ECRU
- RED
- NAVY

- LACQ. WHITE
- LACQ. BLACK
- LACQ. RED
- LACQ. ANTH.

4 uds. 27,2 kg 0,46 m<sup>3</sup>

4 uds. 60 lb 16,3 ft<sup>3</sup>

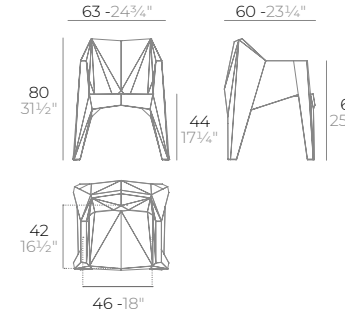

VOXEL chair.



Basic. Básico.

Lacquered. Lacado.

- WHITE
- BLACK
- ECRU
- RED
- NAVY

- LACQ. WHITE
- LACQ. BLACK
- LACQ. RED
- LACQ. ANTH.

4 uds. 25,5 kg 0,42 m<sup>3</sup>

4 uds. 56,2 lb 14,7 ft<sup>3</sup>

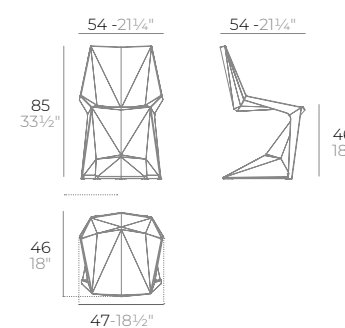

VOXEL mini chair.



Basic. Básico.

Lacquered. Lacado.

- WHITE
- BLACK
- ECRU
- RED
- ALMOND

- LACQ. WHITE
- LACQ. BLACK
- LACQ. RED
- LACQ. ANTH.

4 uds. 13,6 kg 0,21 m<sup>3</sup>

4 uds. 30 lb 7,5 ft<sup>3</sup>

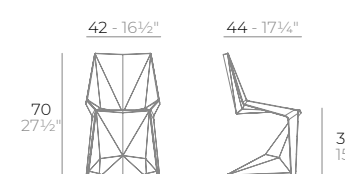

QUARTZ folding chair.



Basic. Básico.

- WHITE
- BLACK
- ECRU

4 uds. 21,1 kg 0,16 m<sup>3</sup>  
4 uds. 46,5 lb 5,7 ft<sup>3</sup>

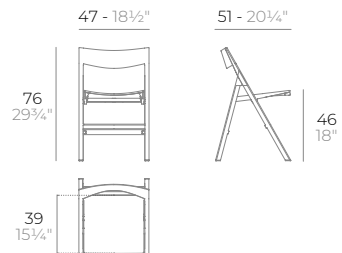

- stackable
- UNE-EN 581-1/2/3
- Fire proof UNE EN 1021 IMO A.652 UNI 9175 BS 5852
- light exposure ISO 4892-2

QUARTZ chair.



Basic. Básico.

Lacquered. Lacado.

- WHITE
- BLACK
- ECRU
- BRONZE
- TORTORA
- LACQ. WHITE
- LACQ. BLACK
- LACQ. ANTH.

4 uds. 15,1 kg 0,32 m<sup>3</sup>  
4 uds. 33,2 lb 11,5 ft<sup>3</sup>

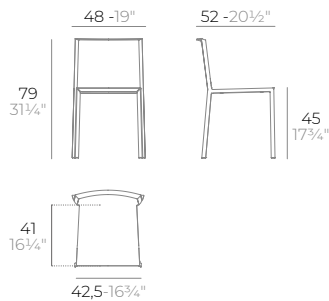

- stackable 16 max.
- cushion available pag. 185
- Fire proof UNE EN 1021 IMO A.652 UNI 9175 BS 5852
- light exposure ISO 4892-2

QUARTZ chair with arms.



Basic. Básico.

Lacquered. Lacado.

- WHITE
- BLACK
- ECRU
- BRONZE
- TORTORA
- LACQ. WHITE
- LACQ. BLACK
- LACQ. ANTH.

4 uds. 15,4 kg 0,38 m<sup>3</sup>  
4 uds. 34 lb 13,5 ft<sup>3</sup>

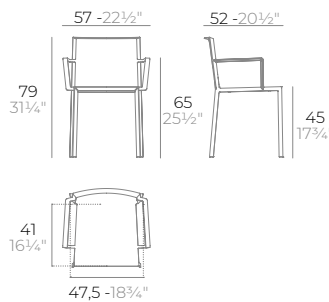

- stackable 10 max.
- cushion available pag. 185
- UNE-EN 581-1/2/3
- BIFMA ANSI/BIFMA X5.4
- Fire proof UNE EN 1021 IMO A.652 UNI 9175 BS 5852
- light exposure ISO 4892-2

KIMONO chair.



Basic. Básico.

- OPAQUE WHITE
- OPAQUE BLACK
- CLEAR CRYSTAL
- CLEAR FUME
- CLEAR AMBAR

4 uds. 19,6 kg 0,53 m<sup>3</sup>  
4 uds. 43,2 lb 18,8 ft<sup>3</sup>

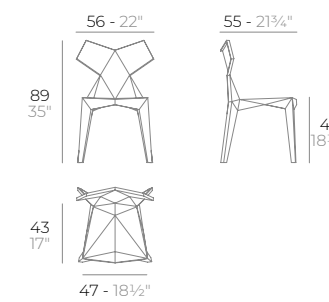

- stackable 6 max.
- cushion available pag. 185
- UNE-EN 581-1/2/3
- BIFMA ANSI/BIFMA X5.4
- Fire proof UNE EN 1021 IMO A.652 UNI 9175 BS 5852
- light exposure ISO 4892-2

KES chair.



Basic. Básico.

Lacquered. Lacado.

- WHITE
- BLACK
- ECRU
- PICKLE
- GRAY

- LACQ. WHITE
- LACQ. BLACK
- LACQ. ANTH.

4 uds. 24,3 kg 0,35 m<sup>3</sup>  
4 uds. 53,6 lb 12,2 ft<sup>3</sup>

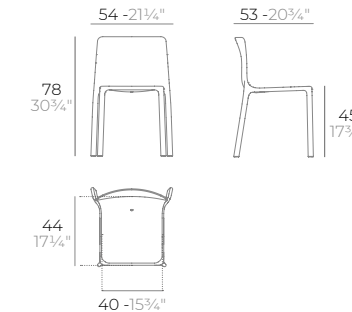

- stackable 12 max.
- cushion available pag. 185
- UNE-EN 581-1/2/3
- BIFMA ANSI/BIFMA X5.4
- Fire proof UNE EN 1021 IMO A.652 UNI 9175 BS 5852
- light exposure ISO 4892-2

KES chair with arms.



Basic. Básico.

Lacquered. Lacado.

- WHITE
- BLACK
- ECRU
- PICKLE
- GRAY

- LACQ. WHITE
- LACQ. BLACK
- LACQ. ANTH.

4 uds. 22,3 kg 0,39 m<sup>3</sup>  
4 uds. 49,2 lb 13,9 ft<sup>3</sup>

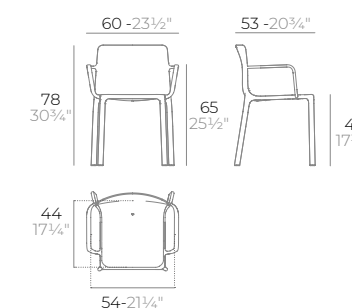

- stackable 8 max.
- cushion available pag. 185
- UNE-EN 581-1/2/3
- BIFMA ANSI/BIFMA X5.4
- Fire proof UNE EN 1021 IMO A.652 UNI 9175 BS 5852
- light exposure ISO 4892-2

SPRITZ chair.



Basic. Básico.

- WHITE
- BLACK
- ECRU
- MOSTAZA
- BRONZE

4 uds. 20 kg 0,34 m<sup>3</sup>  
4 uds. 44,1 lb 11,9 ft<sup>3</sup>

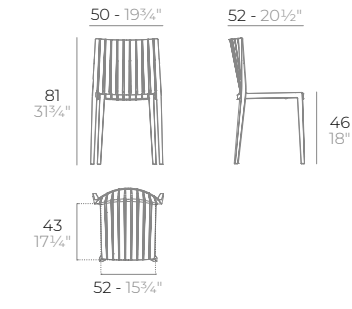

- stackable 10 max.
- cushion available pag. 185
- UNE-EN 581-1/2/3
- BIFMA ANSI/BIFMA X5.4
- Fire proof UNE EN 1021 IMO A.652 UNI 9175 BS 5852
- light exposure ISO 4892-2

SPRITZ chair with arms.



Basic. Básico.

- WHITE
- BLACK
- ECRU
- MOSTAZA
- BRONZE

4 uds. 23 kg 0,39 m<sup>3</sup>  
4 uds. 50,7 lb 13,7 ft<sup>3</sup>

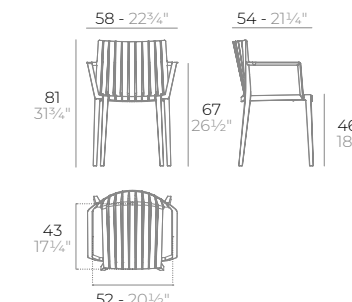

- stackable 8 max.
- cushion available pag. 185
- UNE-EN 581-1/2/3
- Fire proof UNE EN 1021 IMO A.652 UNI 9175 BS 5852
- light exposure ISO 4892-2

SPRITZ armchair.



Basic. Básico.



- WHITE
- BLACK
- ECRU
- MOSTAZA
- BRONZE

4 uds. 34 kg 0,44 m<sup>3</sup>  
4 uds. 75 lb 15,7 ft<sup>3</sup>

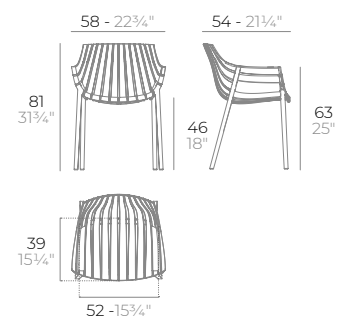

SPRITZ lounge chair.



Basic. Básico.



- WHITE
- BLACK
- ECRU
- MOSTAZA
- BRONZE

4 uds. 26 kg 0,46 m<sup>3</sup>  
4 uds. 57,3 lb 16,3 ft<sup>3</sup>

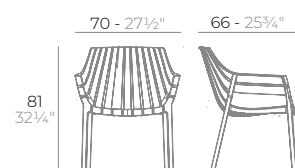

SPRITZ sofa.



Basic. Básico.



- WHITE
- BLACK
- ECRU
- MOSTAZA
- BRONZE

4 uds. 47 kg 1,03 m<sup>3</sup>  
4 uds. 103,6 lb 36,3 ft<sup>3</sup>

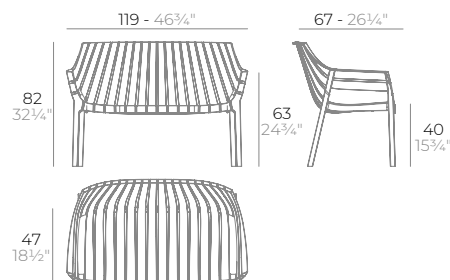

WALL-STREET armchair.



Basic. Básico.

Lacquered. Lacado.



- WHITE
- BLACK
- ECRU
- RED
- BRONZE
- LACQ. WHITE
- LACQ. BLACK
- LACQ. RED
- LACQ. ANTH.

2 uds. 20,5 kg 0,5 m<sup>3</sup>  
2 uds. 45,1 lb 17,6 ft<sup>3</sup>

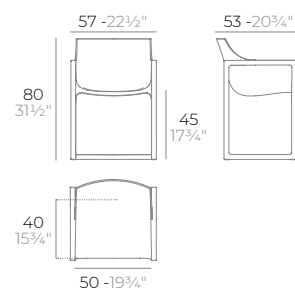

SOLID chair.



Basic. Básico.



- WHITE
- BLACK
- ECRU
- BRONZE

4 uds. 21,1 kg 0,34 m<sup>3</sup>  
4 uds. 46,4 lb 12,1 ft<sup>3</sup>

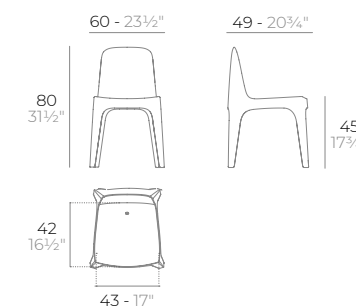

SOLID armchair.



Basic. Básico.



- WHITE
- BLACK
- ECRU
- BRONZE

4 uds. 34,4 kg 0,49 m<sup>3</sup>  
4 uds. 75,9 lb 17,3 ft<sup>3</sup>

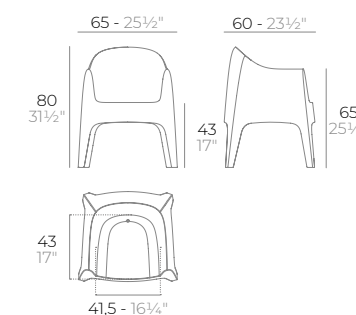

SOLID lounge chair.



Basic. Básico.



- WHITE
- BLACK
- ECRU
- BRONZE

4 uds. 54,4 kg 0,93 m<sup>3</sup>  
4 uds. 119,9 lb 32,8 ft<sup>3</sup>

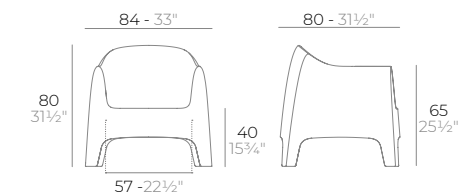

SOLID sofa.



Basic. Básico.



- WHITE
- BLACK
- ECRU
- BRONZE

4 uds. 130,2 kg 1,88 m<sup>3</sup>  
4 uds. 287 lb 66,6 ft<sup>3</sup>

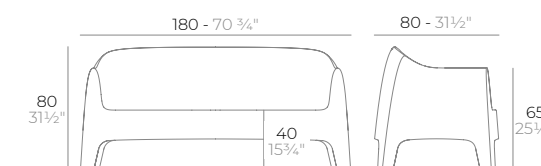

AFRICA stool.



H.76cm

Basic. Básico.

Lacquered. Lacado.

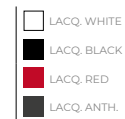
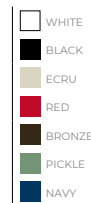

4 uds. 23,9 kg 0,4 m³

4 uds. 52,6 lb 14 ft³

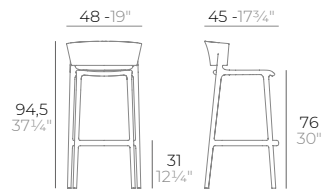

H.66cm

Basic. Básico.

Lacquered. Lacado.

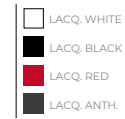
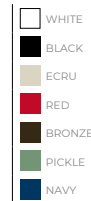

4 uds. 22,4 kg 0,36 m³

4 uds. 49,3 lb 12,8 ft³

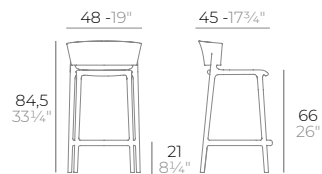

VOXEL stool.



Basic. Básico.

Lacquered. Lacado.

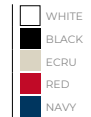

4 uds. 24,6 kg 0,36 m³

4 uds. 54,2 lb 12,8 ft³

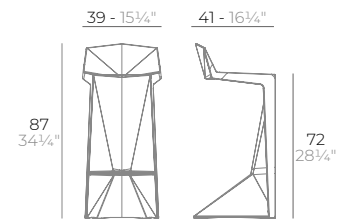

IBIZA stool.



H.76cm

Basic. Básico.

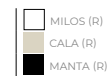

4 uds. 27,5 kg 0,36 m³

4 uds. 60,6 lb 12,8 ft³

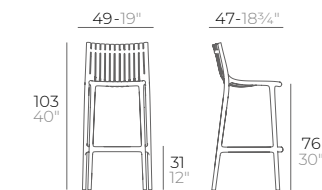

H.66cm

Basic. Básico.

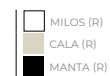

4 uds. 27,3 kg 0,34 m³

4 uds. 60,2 lb 12,1 ft³

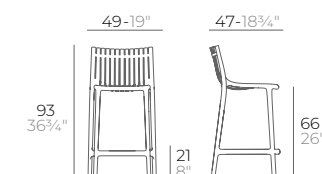

FAZ stool.



H.75cm

Basic. Básico.

Lacquered. Lacado.

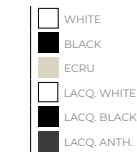

4 uds. 27,2 kg 0,33 m³

4 uds. 60 lb 11,6 ft³

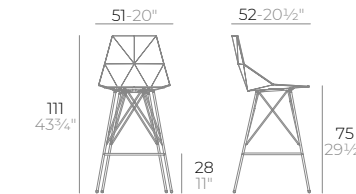

H.66cm

Basic. Básico.

Lacquered. Lacado.

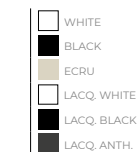

4 uds. 24 kg 0,49 m³

4 uds. 52,9 lb 17,3 ft³

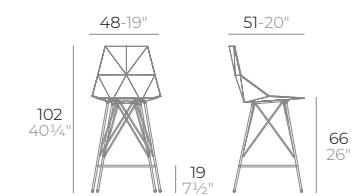

FAZ arm-stool.



H.75cm

Basic. Básico.

Lacquered. Lacado.

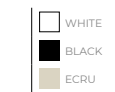
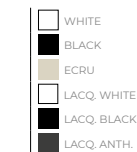

4 uds. 30 kg 0,49 m³

4 uds. 66,1 lb 17,2 ft³

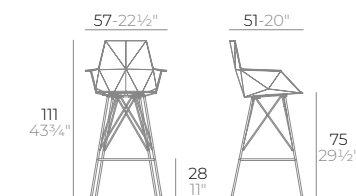

H.66cm

Basic. Básico.

Lacquered. Lacado.

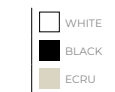
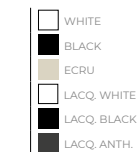

4 uds. 26 kg 0,49 m³

4 uds. 57,3 lb 17,3 ft³

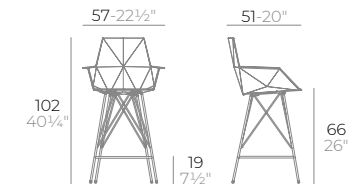

WALL STREET stool.



Basic. Básico.

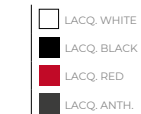
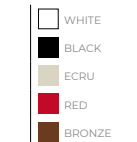

2 uds. 12,9 kg 0,33 m³

2 uds. 28,5 lb 11,6 ft³

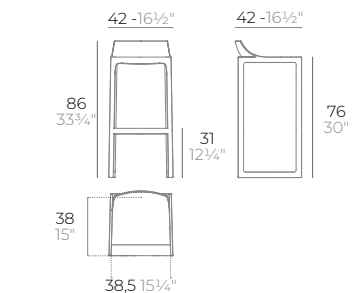

VASES bar stool.

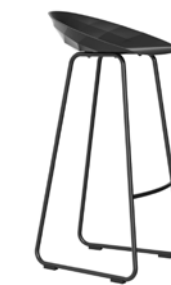

Basic. Básico.

Lacquered. Lacado.

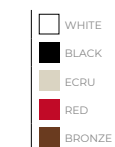
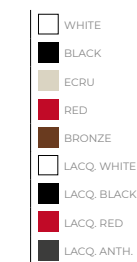

2 uds. 9,1 kg 0,29 m³

2 uds. 20 lb 10,3 ft³

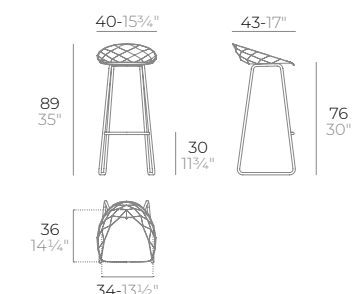

FAZ WOOD stool.



Basic. Básico.

Lacquered. Lacado.

- WHITE
- BLACK
- ECRU
- LACQ. WHITE
- LACQ. BLACK
- LACQ. ANTH.

- WHITE
- BLACK

- WOOD 1
- WOOD 2

4 uds. 30,5 kg 0,48 m<sup>3</sup>

4 uds. 67,3 lb 17 ft<sup>3</sup>

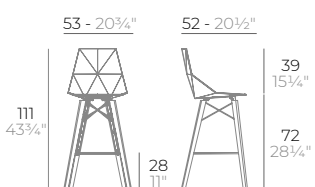

Basic. Básico.

Lacquered. Lacado.

- WHITE
- BLACK
- ECRU
- LACQ. WHITE
- LACQ. BLACK
- LACQ. ANTH.

- WHITE
- BLACK

- WOOD 1
- WOOD 2

4 uds. 25,2 kg 0,44 m<sup>3</sup>

4 uds. 55,6 lb 15,6 ft<sup>3</sup>

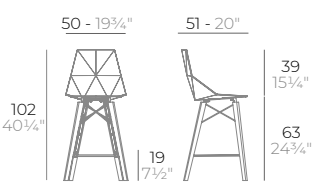

FAZ WOOD arm-stool.



H.75cm

Basic. Básico.

Lacquered. Lacado.

- WHITE
- BLACK
- ECRU
- LACQ. WHITE
- LACQ. BLACK
- LACQ. ANTH.

- WHITE
- BLACK

- WOOD 1
- WOOD 2

4 uds. 26 kg 0,54 m<sup>3</sup>

4 uds. 57,3 lb 19,1 ft<sup>3</sup>

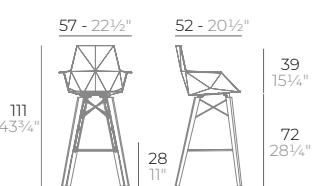

H.66cm

Basic. Básico.

Lacquered. Lacado.

- WHITE
- BLACK
- ECRU
- LACQ. WHITE
- LACQ. BLACK
- LACQ. ANTH.

- WHITE
- BLACK

- WOOD 1
- WOOD 2

4 uds. 25,2 kg 0,44 m<sup>3</sup>

4 uds. 55,6 lb 15,6 ft<sup>3</sup>

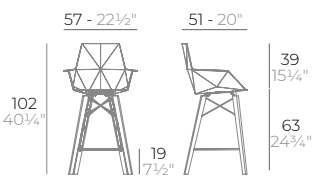

BROOKLYN stool.



H.76cm

Basic. Básico.

Lacquered. Lacado.

- WHITE
- BLACK
- ECRU
- RED
- TORTORA
- PICKLE

- LACQ. WHITE
- LACQ. BLACK
- LACQ. RED
- LACQ. ANTH.

4 uds. 20,2 kg 0,35 m<sup>3</sup>

4 uds. 44,5 lb 12,2 ft<sup>3</sup>

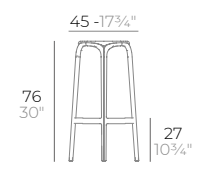

H.66cm

Basic. Básico.

Lacquered. Lacado.

- WHITE
- BLACK
- ECRU
- RED
- TORTORA
- PICKLE

- LACQ. WHITE
- LACQ. BLACK
- LACQ. RED
- LACQ. ANTH.

4 uds. 16,5 kg 0,31 m<sup>3</sup>

4 uds. 36,4 lb 11 ft<sup>3</sup>

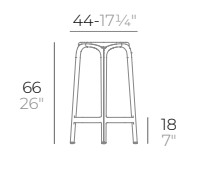

SPRITZ stool.



H.75cm

Basic. Básico.

- WHITE
- BLACK
- ECRU
- MOSTAZA
- BRONZE

4 uds. 22 kg 0,35 m<sup>3</sup>

4 uds. 48,5 lb 12,2 ft<sup>3</sup>

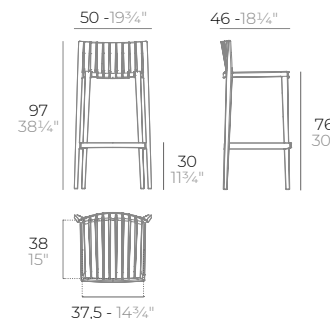

Pack 2 Stools + Table.  
Pack 2 taburetes + mesa.  
(2x 56019 + 1x 56018)

H.66cm

Basic. Básico.

- WHITE
- BLACK
- ECRU
- MOSTAZA
- BRONZE

4 uds. 21,8 kg 0,32 m<sup>3</sup>

4 uds. 48,1 lb 11,1 ft<sup>3</sup>

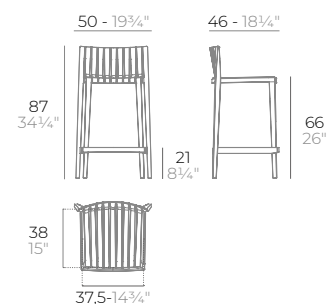

Pack 2 Stools + Table.  
Pack 2 taburetes + mesa.  
(2x 56020 + 1x 56018)



SUN LOUNGERS  
TUMBONAS

SPRITZ sun lounger.



Basic. Básico.  
(Price/unit in 12 units package)

- WHITE
- GREY
- ECRU
- BRONZE

4 uds. 74 kg 1,2 m<sup>3</sup>

4 uds. 163,1 lb 42,3 ft<sup>3</sup>

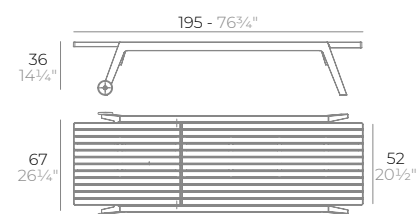

Basic. Básico.  
(Price/unit in 4 units package)

4 uds. 106,6 kg 1,34 m<sup>3</sup>

4 uds. 235 lb 47,5 ft<sup>3</sup>





**AFRICA sun lounger.**



Basic. Básico.  
(Price/unit in 12 units package)

Basic. Básico.  
(Price/unit in 4 units package)

Optional.

Spare Canvas Kit (batyline fabric)  
Kit lona de recambio (tejido batyline)

Price per unit  
Precio unidad

Basic colours  
Colores básicos

- WHITE
- GREY
- ECRU



discover more!  
conoce más!

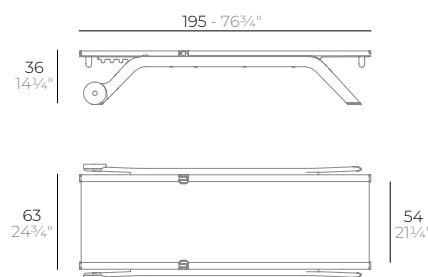

**IBIZA sun lounger's table.**



Basic. Básico.

- WHITE
- BLACK
- ECRU
- PICKLE

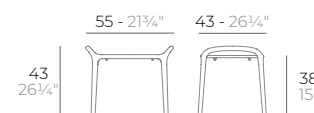

**IBIZA sun lounger.**



Basic. Básico.

**REVOLUTION**  
Recycled plastic from the Mediterranean\*

- stackable
- UNE-EN 581-1/2/3
- BIFMA ANSI/BIFMA X5.4
- Fire proof UNE EN 1021 IMO A.652 UNI 9175 BS 5852
- light exposure ISO 4892-2

- WHITE
- ECRU
- MILOS (R)
- CALA (R)
- MANTA (R)

4 uds. 71,7 kg 1,17 m<sup>3</sup>  
4 uds. 158,1 lb 41,3 ft<sup>3</sup>

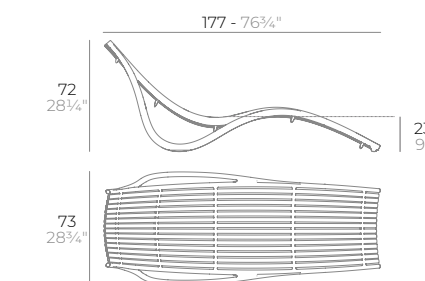

**TABLES  
MESAS**

**IBIZA side table / low stool**



Basic. Básico.

**REVOLUTION**  
Recycled plastic from the Mediterranean\*

- stackable
- Fire proof UNE EN 1021 IMO A.652 UNI 9175 BS 5852
- light exposure ISO 4892-2

- WHITE
- BLACK
- ECRU
- PICKLE
- MILOS (R)
- CALA (R)
- MANTA (R)

4 uds. 15,3 kg 0,22 m<sup>3</sup>  
4 uds. 33,8 lb 7,7 ft<sup>3</sup>

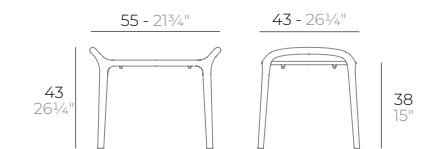

**VOXEL sun lounger.**



Basic. Básico.  
(Price/unit in 12 units package)

Basic. Básico.  
(Price/unit in 4 units package)

Optional.

Spare Canvas Kit (batyline fabric)  
Kit lona de recambio (tejido batyline)

Price per unit  
Precio unidad

Basic colours  
Colores básicos

- WHITE
- GREY
- ECRU



4 uds. 88,4 kg 1,2 m<sup>3</sup>  
4 uds. 194,8 lb 42,2 ft<sup>3</sup>

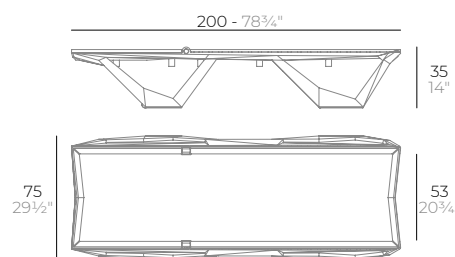

**VOXEL sun lounger's table.**



Basic. Básico.

- WHITE
- GREY
- ECRU

4 uds. 9 kg 0,04 m<sup>3</sup>  
4 uds. 19,8 lb 1,6 ft<sup>3</sup>

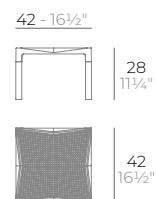

**VOXEL sun lounger table.**



Basic. Básico.

- stackable
- Fire proof UNE EN 1021 IMO A.652 UNI 9175 BS 5852
- light exposure ISO 4892-2

- WHITE
- GRAY
- ECRU

4 uds. 9 kg 0,04 m<sup>3</sup>  
4 uds. 19,8 lb 1,6 ft<sup>3</sup>

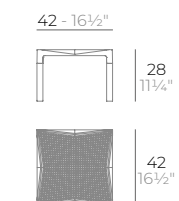

**SOLID coffee table.**



Basic. Básico.

- stackable max. 6
- Fire proof UNE EN 1021 IMO A.652 UNI 9175 BS 5852
- light exposure ISO 4892-2

- WHITE
- BLACK
- ECRU

4 uds. 41,3 kg 0,58 m<sup>3</sup>  
4 uds. 91 lb 20,5 ft<sup>3</sup>

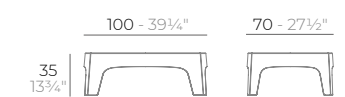

**SOLID dinning table.**



Basic. Básico.

- stackable max. 6
- Fire proof UNE EN 1021 IMO A.652 UNI 9175 BS 5852
- light exposure ISO 4892-2

- WHITE
- BLACK
- ECRU

4 uds. 44,4 kg 1,39 m<sup>3</sup>  
4 uds. 97,9 lb 49 ft<sup>3</sup>

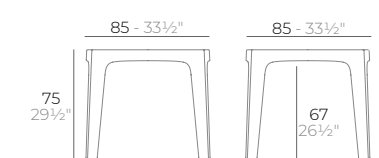

\*In our VONDOM Revolution range, we manufacture our products using recycled plastic, from the Mediterranean, extending it's life and enhancing it's real value. Due to the origin of this raw material slight natural imperfections may appear, which gives every piece it's own personality and spirit.

\*En las colecciones de VONDOM Revolution trabajamos con plástico reciclado del mar Mediterráneo, alargamos su vida y potenciamos su valor. El origen de esta materia prima puede causar ligeras imperfecciones naturales que dotan a las piezas de una personalidad y espíritu propios.

Price per unit  
Precio unidad

WHITE  
BLACK  
ECRU  
BRONZE  
MOSTAZA

Packaging  
Embalaje

Stackable  
Apilable

Leg's colors - Color de estructura

WHITE ECRU BLACK

Table Top finishes - Acabado de tablero

HPL Black edge  
HPL Borde negro

HPL Solid Core

SPRITZ sun lounger table.



4 uds. 10,8 kg 0,04 m<sup>3</sup>  
4 uds. 23,8 lb 1,5 ft<sup>3</sup>

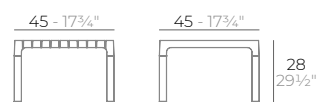

QUARTZ MESA. Table. Table. Tisch. Tavolo.



Ø59 cm  
2 ud - 18,5 kg 0,1 m<sup>3</sup> - 33,4 lb 3,42 ft<sup>3</sup>

Ø69 cm  
2 ud - 21,5 kg 0,1 m<sup>3</sup> - 50 lb 3,6 ft<sup>3</sup>

Ø79 cm  
2 ud - 25 kg 0,11 m<sup>3</sup> - 55 lb 3,84 ft<sup>3</sup>

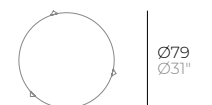
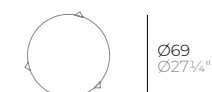

SPRITZ sun lounger table.



4 uds. 20,3 kg 0,08 m<sup>3</sup>  
4 uds. 44,8 lb 2,8 ft<sup>3</sup>

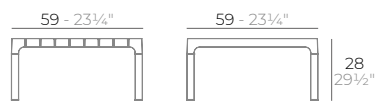

Ø79 cm  
2 ud - 29 kg 0,14 m<sup>3</sup> - 63 lb 4,66 ft<sup>3</sup>

Ø90 cm  
2 ud - 32,7 kg 0,15 m<sup>3</sup> - 72 lb 4,9 ft<sup>3</sup>

Ø100 cm  
2 ud - 37 kg 0,16 m<sup>3</sup> - 82 lb 5,2 ft<sup>3</sup>

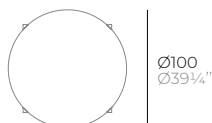
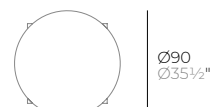
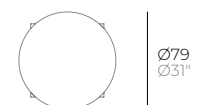

SPRITZ coffee table.



4 uds. 21,1 kg 0,08 m<sup>3</sup>  
4 uds. 46,6 lb 2,9 ft<sup>3</sup>

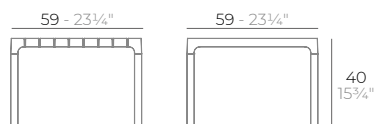

59x59 cm  
2 ud - 12,5 kg 0,12 m<sup>3</sup> - 28 lb 4,23 ft<sup>3</sup>

69x69 cm  
2 ud - 27,5 kg 0,13 m<sup>3</sup> - 61 lb 4,41 ft<sup>3</sup>

79x79 cm  
2 ud - 32 kg 0,13 m<sup>3</sup> - 70 lb 4,66 ft<sup>3</sup>

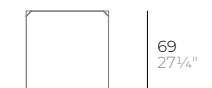

SPRITZ coffee table.



4 uds. 31,8 kg 0,13 m<sup>3</sup>  
4 uds. 70,1 lb 4,6 ft<sup>3</sup>

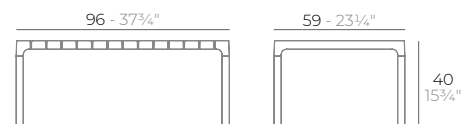

SPRITZ bar table.



1 ud. 10,7 kg 0,28 m<sup>3</sup>  
1 ud. 23,5 lb 9,8 ft<sup>3</sup>

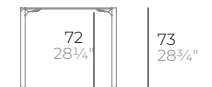
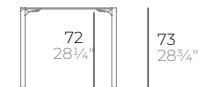
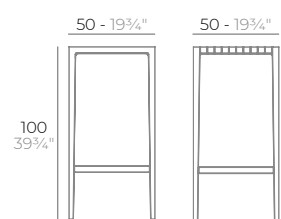

**FRAME ALUMINIUM dining table.**

	<p>60x60x74 cm 23½"x23½"x29¼"</p> <p>HPL 12 kg 0,06 m³ - 26 lb 2,12 ft³</p>
	<p>70x70x74 cm 27½"x27½"x29¼"</p> <p>HPL 14 kg 0,08 m³ - 31 lb 2,83 ft³</p>
	<p>80x80x74 cm 31½"x31½"x29¼"</p> <p>HPL 17 kg 0,10 m³ - 37 lb 3,53 ft³</p>
	<p>90x90x74 cm 35½"x35½"x29¼"</p> <p>HPL 20 kg 0,13 m³ - 43 lb 4,59 ft³</p>
	<p>100x100x74 cm 39¼"x39¼"x29¼"</p> <p>HPL 23 kg 0,16 m³ - 50 lb 5,65 ft³</p>
	<p>120x120x74 cm 47¼"x47¼"x29¼"</p> <p>HPL 30 kg 0,23 m³ - 67 lb 8,12 ft³</p>

**FRAME ALUMINIUM high table.**

	<p>140x60x105 cm 55"x23½"x41¼"</p> <p>HPL 22 kg 0,14 m³ - 48 lb 4,95 ft³</p>
	<p>200x60x105 cm 78¾"x23½"x41¼"</p> <p>HPL 29 kg 0,20 m³ - 62 lb 7,06 ft³</p>

**FRAME ALUMINIUM coffee table.**

	<p>100x100x32 cm 39¼"x39¼"x12½"</p> <p>HPL 21 kg 0,17 m³ - 45 lb 6 ft³</p>
	<p>160x100x32 cm 63"x39¼"x12½"</p> <p>HPL 31 kg 0,26 m³ - 68 lb 9,18 ft³</p>

Table Top finishes - Acabado de tablero		
HPL Black edge HPL Borde negro	HPL Solid Core	DEKTON® Table top Sobre DEKTON®

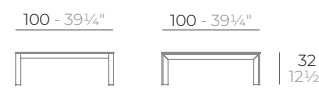
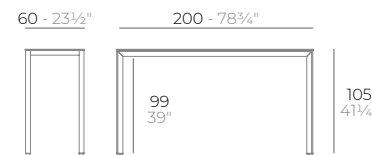
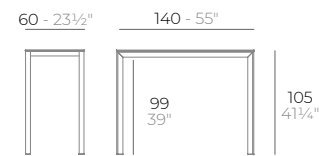
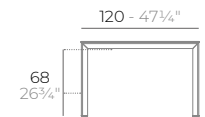
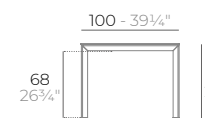
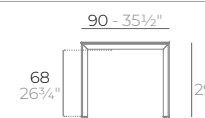
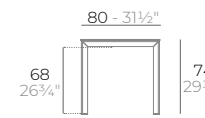
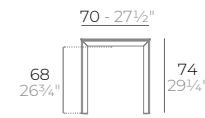
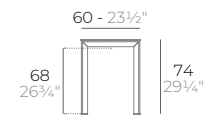

**FRAME ALUMINIUM lounge table.**





	<p>160x80x74 cm 63"x31½"x29¼"</p> <p>HPL 28 kg 0,21 m³ - 62 lb 7 ft³</p>
	<p>160x90x74 cm 63"x35½"x29¼"</p> <p>HPL 30 kg 0,23 m³ - 66 lb 8,12 ft³</p>
	<p>160x100x74 cm 63"x39¼"x29¼"</p> <p>HPL 33 kg 0,26 m³ - 71 lb 9,18 ft³</p>
	<p>180x80x74 cm 70¾"x31½"x29¼"</p> <p>HPL 31 kg 0,23 m³ - 67 lb 8,12 ft³</p>
	<p>200x90x74 cm 78¾"x35½"x29¼"</p> <p>HPL 36 kg 0,3 m³ - 80 lb 10,6 ft³</p>
	<p>200x100x74 cm 78¾"x39¼"x29¼"</p> <p>HPL 40 kg 0,33 m³ - 86 lb 11,7 ft³</p>
	<p>250x100x74 cm 98½"x39¼"x29¼"</p> <p>HPL 0,4 m³ - 12,2 ft³</p>
	<p>300x120x74 cm 118"x47¼"x29¼"</p> <p>HPL 69 kg 0,6 m³ - 150 lb 21,2 ft³</p>

Table Top finishes - Acabado de tablero		
HPL Black edge HPL Borde negro	HPL Solid Core	DEKTON® Table top Sobre DEKTON®



**FAZ WOOD dining table.**

Leg's colors - Color de estructura  
 WOOD 1 WOOD 2  
 WHITE BLACK ECRU  
 Table Top finishes - Acabado de tablero  
 HPL Black edge HPL Borde negro HPL Solid Core DEKTON® Table top Sobre DEKTON®

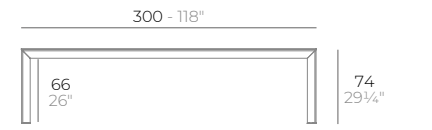
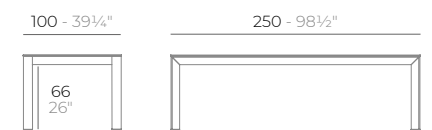
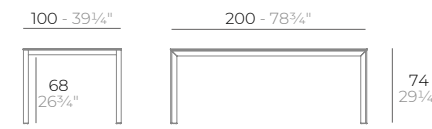
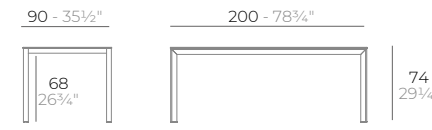
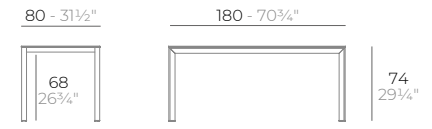
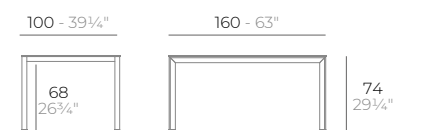
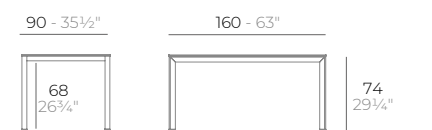
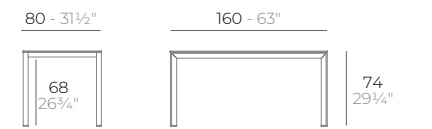

**60x60x74 cm**  
 23½"x23½"x29¼"  
 4u. HPL 44kg 0,67m³ - 97lb 23,7ft³

**70x70x74 cm**  
 27½"x27½"x29¼"  
 4u. HPL 52kg 0,68m³ - 114lb 24ft³

**80x80x74 cm**  
 31½"x31½"x29¼"  
 4u. HPL 60kg 0,69m³ - 133lb 24,5ft³



**Ø60x74 cm**  
 Ø23½"x29¼"  
 4u. HPL 40kg 0,67m³ - 88lb 23,7ft³

**Ø70x74 cm**  
 Ø27½"x29¼"  
 4u. HPL 46kg 0,68m³ - 101lb 24ft³

**Ø80x74 cm**  
 Ø31½"x29¼"  
 4u. HPL 53kg 0,69m³ - 116lb 24,5ft³

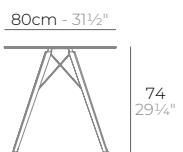
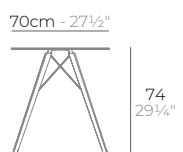
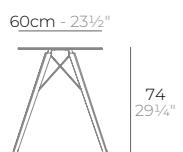

**FAZ WOOD high table.**



**50x50x105 cm**  
 19¾"x19¾"x41¼"  
 4u. HPL 43kg 0,72m³ - 95lb 25,5ft³

**60x60x105 cm**  
 23½"x23½"x41¼"  
 4u. HPL 49kg 0,72m³ - 108lb 25,5ft³

**Ø50x105 cm**  
 Ø19¾"x41¼"  
 4u. HPL 40kg 0,72m³ - 89lb 25,5ft³

**Ø60x105 cm**  
 Ø23½"x41¼"  
 4u. HPL 45kg 0,72m³ - 99lb 25,5ft³

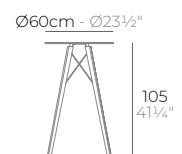
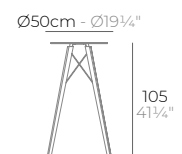
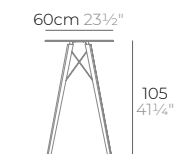
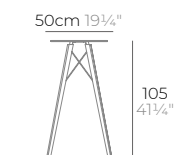

**FAZ WOOD lounge table.**



**90x90x74 cm**  
 35½"x35½"x29¼"  
 1u. HPL 27kg 0,18m³ - 60lb 6,5ft³

**100x100x74 cm**  
 39¼"x39¼"x29¼"  
 1u. HPL 31kg 0,22m³ - 68lb 7,8ft³

**Ø120x74 cm**  
 Ø47¼"x29¼"  
 1u. HPL 35kg 0,31m³ - 77lb 10,9ft³

**Ø140x74 cm**  
 Ø55"x29¼"  
 1u. HPL 41kg 0,41m³ - 89lb 14,5ft³

**200x90x74 cm**  
 78¾"x35½"x29¼"  
 1u. HPL 47kg 0,38m³ - 103lb 13,4ft³

**200x100x74 cm**  
 78¾"x39¼"x29¼"  
 1u. HPL 50kg 0,41m³ - 110lb 14,6ft³

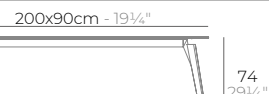
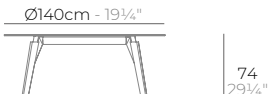
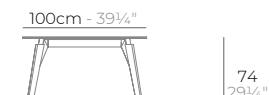
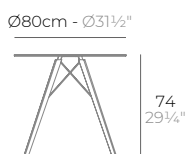
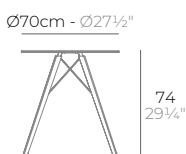
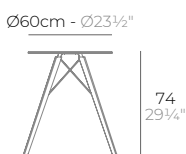

Fijo Fixed Abatible Collapsible top Fijo para vidrio Fixed for glass

**FAZ Low Table 3P**



Ø65x50 cm  
 Ø25½"x19¾"  
 4 ud - 15,6 kg 0,14 m³ - 13,2 lb 4,94 ft³

- Tableteros disponibles Available table tops
- Ø50 cm Ø19¼" 50 x 50 cm 19¼" x 19¼"
  - Ø59 cm Ø23¼" 59 x 59 cm 23¼" x 23¼"
  - Ø69 cm Ø27¼"

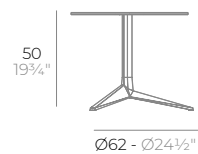

Fijo Fixed Abatible Collapsible top Fijo para vidrio Fixed for glass

**FAZ Dining Table Double 3P**



112x58 cm  
 44½"x22¾"  
 1 ud - 8,8 kg 0,10 m³ - 19,58 lb 3,52 ft³

- 119 x 69 cm 46¾" x 27¼"

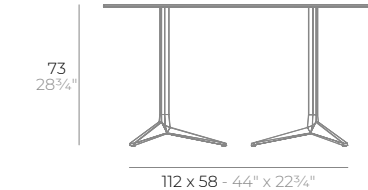

**FAZ Low Table 4P**



Ø80x50 cm -  
 Ø31½"x19¾"  
 4 ud - 23 kg 0,24m³ - 15,65 lb 8,47 ft³

- Ø79 cm Ø31" 69 x 69 cm 27¼" x 27¼"
- Ø89 cm Ø37" 79 x 79 cm 31" x 31"
- Ø100 cm Ø39¼" 89 x 89 cm 37" x 37"

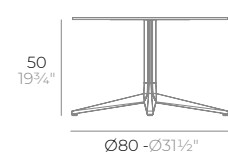

**FAZ Dining Table Double 4P**



138x59 cm  
 54¼"x23¼"  
 1 ud - 13 kg - 0,12 m³ - 28,72 lb 4,23 ft³

- 158 x 79 cm 62¼" x 31"

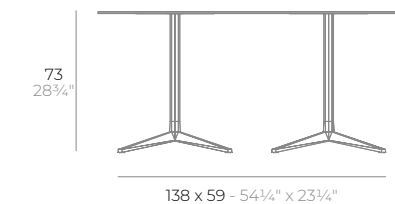

**FAZ Low Table 4P+**



Ø96,5x50 cm  
 Ø37¾"x19¾"  
 4 ud - 29,6 kg 0,34 m³ - 65,30 lb 12 ft³

- Ø100 cm Ø39¼" 100 x 100 cm 39¼" x 39¼"
- Ø120 cm Ø47¼"

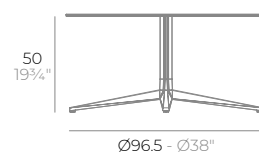

**FAZ High Table 3P**



Ø65x105 cm  
 Ø25½"x41¼"  
 4 ud - 15,7 kg 0,14 m³ - 15,43 lb 4,9 ft³

- Ø50 cm Ø19¼" 50 x 50 cm 19¼" x 19¼"
- Ø59 cm Ø23¼" 59 x 59 cm 23¼" x 23¼"

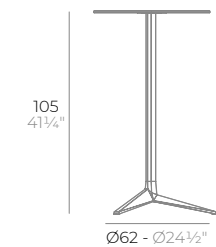

**FAZ Dining Table 3P**



Ø65x73 cm  
 Ø25½"x28¾"  
 4 ud - 15,6 kg 0,14 m³ - 14,33 lb 4,94 ft³

- Ø50 cm Ø19¼" 50 x 50 cm 19¼" x 19¼"
- Ø59 cm Ø23¼" 59 x 59 cm 23¼" x 23¼"
- Ø69 cm Ø27¼"

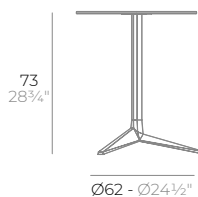

**FAZ High Table 4P**



Ø80x105 cm  
 Ø31½"x41¼"  
 4 ud - 26,1 kg 0,31 m³ - 17,47 lb 10,9 ft³

- 69 x 69 cm 27¼" x 27¼"

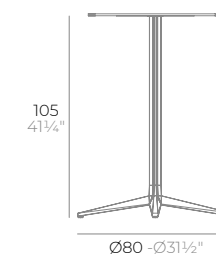

**FAZ Dining Table 4P**



Ø80x73 cm  
 Ø31½"x28¾"  
 4 ud - 24,2 kg 0,24 m³ - 14,42 lb 8,5 ft³

- Ø79 cm Ø31" 69 x 69 cm 27¼" x 27¼"
- Ø89 cm Ø37" 79 x 79 cm 31" x 31"
- Ø100 cm Ø39¼" 89 x 89 cm 37" x 37"

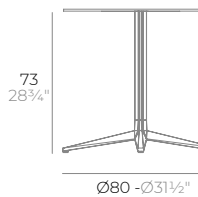

**FAZ Dining Table 4P+**



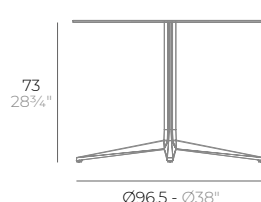

Ø96,5x73 cm  
 Ø37¾"x28¾"  
 4 ud - 30,8 kg 0,34 m³ - 67,88 lb 12 ft³

- Ø100 cm Ø39¼" 100 x 100 cm 39¼" x 39¼"
- Ø120 cm Ø47¼"





FAZ Table Tops

- 

Ø50 cm - Ø19¼"  
 2 ud - 5,6 kg 0,02 m³ - 12,3 lb 0,58 ft³
- 

Ø59 cm - Ø23½"  
 2 ud - 7,8 kg 0,02 m³ - 17,2 lb 0,58 ft³
- 

Ø69 cm - Ø27¼"  
 2 ud - 10,6 kg - 0,22 m³ - 23,3 lb 0,77 ft³
- 

Ø79 cm - Ø31"  
 2 ud - 13,8 kg 0,03 m³ - 23,3 lb 1 ft³
- 

Ø89 cm - Ø35"  
 2 ud - 17,6 kg - 0,04 m³ - 38,8 lb 1,25 ft³
- 

Ø100 cm - Ø39¼"  
 2 ud - 22,2 kg - 0,04 m³ - 48,9 lb 1,5 ft³
- 

Ø120 cm - Ø47¼"  
 2 ud - 37,4 kg 0,07 m³ - 82,4 lb 1,9 ft³

- 

50x50 cm - 19¼"x19¼"  
 2 ud - 7 kg 0,02 m³ - 15,4 lb 0,58 ft³
- 

59x59 cm - 23¼"x23¼"  
 2 ud - 9,8 kg 0,02 m³ - 21,6 lb 0,58 ft³
- 

69x69 cm - 27¼"x27¼"  
 2 ud - 13,4 kg - 0,02 m³ - 61,59 lb 0,77 ft³
- 

79x79 cm - 31"x31"  
 2 ud - 17,6 kg - 0,03 m³ - 77,6 lb 1 ft
- 

89x89 cm - 35"x35"  
 2 ud - 22,4 kg - 0,03 m³ - 98,7 lb 1,25 ft³
- 

100x100 cm - 39¼" x 39¼"  
 2 ud - 28,2 kg 0,04 m³ - 62,1 lb 1,5 ft³

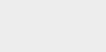
- 

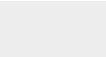
119x69 cm - 46¾"x27¼"  
 2 ud - 11,5 kg 0,02 m³ - 25,5 lb 0,35 ft³
- 

158x79cm - 62¼" x 31"  
 2 ud - 17,6 kg 0,02 m³ - 38,7 lb 0,35 ft³

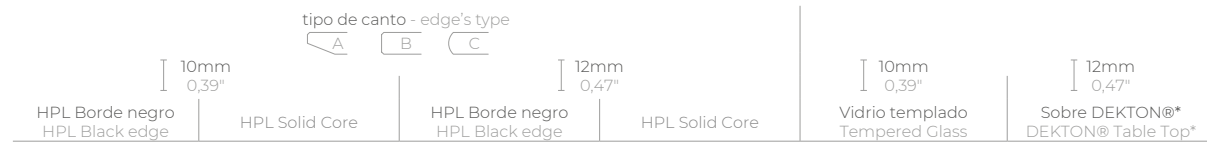

HPL SOLID CORE FINISHES



HPL BLACK-EDGE FINISHES

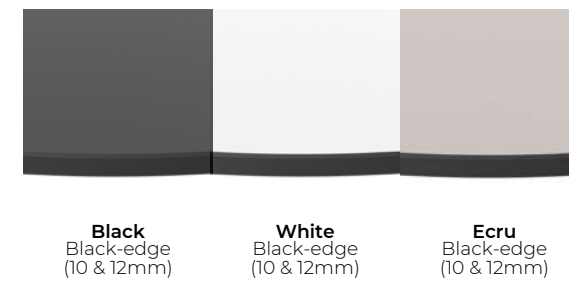

DEKTON CERAMIC SURFACES



GLASS SURFACES



HPL EDGES

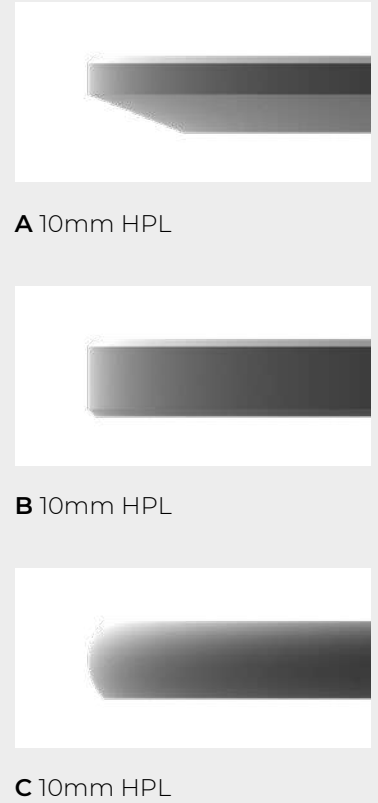

\*Dekton's table tops are not available for collapsable table bases.  
 \*Los tableros Dekton no están disponibles para piés de mesa abatibles.

Fijo Fixed Abatible Collapsible top Fijo para vidrio Fixed for glass

Tableros disponibles Available table tops

### MARI-SOL Low Table 3P

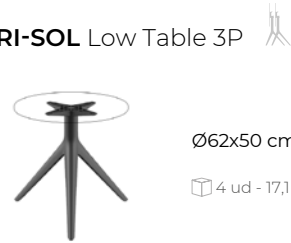

Ø62x50 cm - Ø24½"x19¾"

4 ud - 17,1 kg 0,22 m³ - 37,75 lb 7,84 ft³

- Ø50 cm Ø19¼" 50 x 50 cm 19¼" x 19¼"
- Ø59 cm Ø23¼" 59 x 59 cm 23¼" x 23¼"
- Ø69 cm Ø27¼"

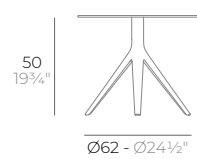

### MARI-SOL Low Table 4P



Ø80x50 cm - Ø31½"x19¾"

4 ud - 22,4 kg 0,23 m³ - 49,52 lb 8,34 ft³

- Ø79 cm Ø31" 69 x 69 cm 27¼" x 27¼"
- Ø89 cm Ø37" 79 x 79 cm 31" x 31"
- Ø100 cm Ø39¼" 89 x 89 cm 37" x 37"

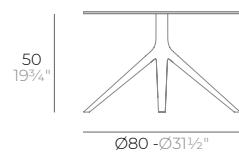

### MARI-SOL Low Table 4P+



Ø96,5x50 cm - Ø37¾"x19¾"

4 ud - 29,6 kg 0,57 m³ - 65,30 lb 20,31 ft³

- Ø100 cm Ø39¼" 100 x 100 cm 39¼" x 39¼"
- Ø120 cm Ø47¼"

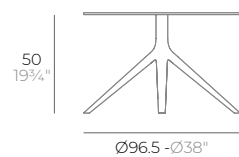

### MARI-SOL Dining Table 3P



Ø62x73 cm - Ø24½"x28¾"

4 ud - 18,7 kg 0,22 m³ - 41,34 lb 7,84 ft³

- Ø50 cm Ø19¼" 50 x 50 cm 19¼" x 19¼"
- Ø59 cm Ø23¼" 59 x 59 cm 23¼" x 23¼"
- Ø69 cm Ø27¼"

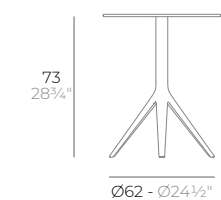

### MARI-SOL Dining Table 4P



Ø80x73 cm - Ø31½"x28¾"

4 ud - 24,2 kg 0,23 m³ - 53,46 lb 8,34 ft³

- Ø79 cm Ø31" 69 x 69 cm 27¼" x 27¼"
- Ø89 cm Ø37" 79 x 79 cm 31" x 31"
- Ø100 cm Ø39¼" 89 x 89 cm 37" x 37"

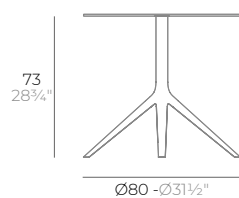

### MARI-SOL Dining Table 4P+



Ø96,5x73 cm - Ø37¾"x28¾"

4 ud - 30,8 kg 0,57 m³ - 67,88 lb 20,31 ft³

- Ø100 cm Ø39¼" 100 x 100 cm 39¼" x 39¼"
- Ø120 cm Ø47¼"

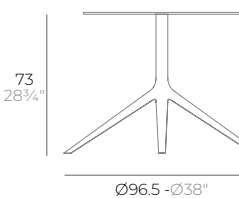

Fijo Fixed Abatible Collapsible top Fijo para vidrio Fixed for glass

Tableros disponibles Available table tops

### MARI-SOL Dining Table double 3P



112x58 cm - 44½"x22¾"

1 ud - 9,6 kg 0,11 m³ - 21,18 lb 4,14 ft³

119 x 69 cm 46¾" x 27¼"

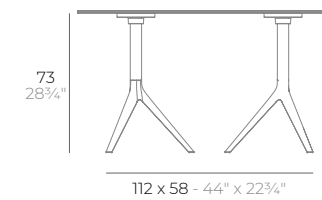

### MARI-SOL Dining Table double 4P



138x59 cm - 54¼"x23¼"

1 ud - 13 kg 0,17 m³ - 28,54 lb 6,16 ft³

158 x 79 cm 62¼" x 31"

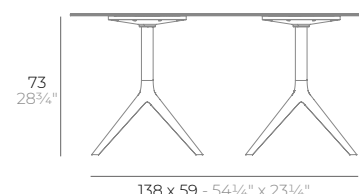

### MARI-SOL High Table 3P

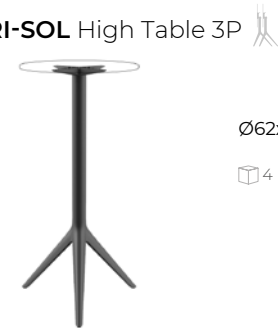

Ø62x105 cm - Ø24½"x41¼"

4 ud - 21,6 kg 0,22 m³ - 47,62 lb 7,84 ft³

- Ø50 cm Ø19¼" 50 x 50 cm 19¼" x 19¼"
- Ø59 cm Ø23¼" 59 x 59 cm 23¼" x 23¼"

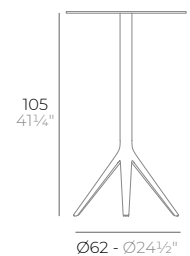

### MARI-SOL High Table 4P



Ø80x105 cm - Ø31½"x41¼"

4 ud - 26,9 kg 0,23 m³ - 59,38 lb 8,34 ft³

69 x 69 cm 27¼" x 27¼"

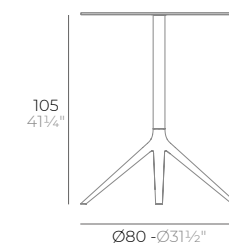



MARI-SOL Table Tops

- 

Ø50 cm - Ø19¼"  
2 ud - 5,6 kg 0,02 m³ - 12,3 lb 0,58 ft³
- 

Ø59 cm - Ø23½"  
2 ud - 7,8 kg 0,02 m³ - 17,2 lb 0,58 ft³
- 

Ø69 cm - Ø27¼"  
2 ud - 10,6 kg - 0,22 m³ - 23,3 lb 0,77 ft³
- 

Ø79 cm - Ø31"  
2 ud - 13,8 kg 0,03 m³ - 23,3 lb 1 ft³
- 

Ø89 cm - Ø35"  
2 ud - 17,6 kg - 0,04 m³ - 38,8 lb 1,25 ft³
- 

Ø100 cm - Ø39¼"  
2 ud - 22,2 kg - 0,04 m³ - 48,9 lb 1,5 ft³
- 

Ø120 cm - Ø47¼"  
2 ud - 37,4 kg 0,07 m³ - 82,4 lb 1,9 ft³

- 

50x50 cm - 19¼"x19¼"  
2 ud - 7 kg 0,02 m³ - 15,4 lb 0,58 ft³
- 

59x59 cm - 23¼"x23¼"  
2 ud - 9,8 kg 0,02 m³ - 21,6 lb 0,58 ft³
- 

69x69 cm - 27¼"x27¼"  
2 ud - 13,4 kg - 0,02 m³ - 61,59 lb 0,77 ft³
- 

79x79 cm - 31"x31"  
2 ud - 17,6 kg - 0,03 m³ - 77,6 lb 1 ft
- 

89x89 cm - 35"x35"  
2 ud - 22,4 kg - 0,03 m³ - 98,7 lb 1,25 ft³
- 

100x100 cm - 39¼" x 39¼"  
2 ud - 28,2 kg 0,04 m³ - 62,1 lb 1,5 ft³

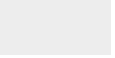
- 

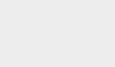
119x69 cm - 46¾"x27¼"  
2 ud - 11,5 kg 0,02 m³ - 25,5 lb 0,35 ft³
- 

158x79cm - 62¼" x 31"  
2 ud - 17,6 kg 0,02 m³ - 38,7 lb 0,35 ft³

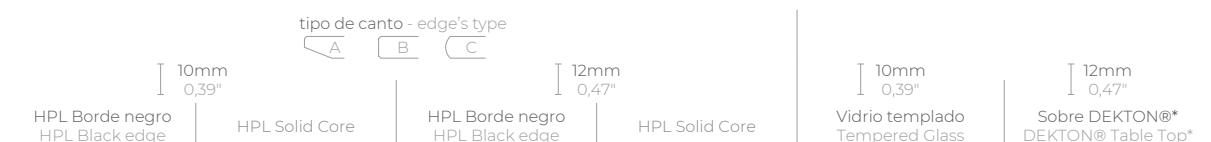

HPL SOLID CORE FINISHES

<b>White</b> Solid Core (10 & 12mm)	<b>Castoro Fiber 7006</b> Solid Core (10mm)	<b>Traffic Gray 7008</b> Solid Core (10mm)	<b>Modo Green 7003</b> Solid Core (10mm)	<b>Notte Blue 7001</b> Solid Core (10mm)
<b>Crema 7007</b> Solid Core (10mm)	<b>Piombo Gray 7005</b> Solid Core (10mm)	<b>British Gray 7009</b> Solid Core (10mm)	<b>Cacao 7004</b> Solid Core (10mm)	<b>Purjai Red 7002</b> Solid Core (10mm)
<b>Marmo Gioia 7101</b> Solid Core (10mm)	<b>Yule Brown 7105</b> Solid Core (10mm)	<b>Pulpis Gray 7104</b> Solid Core (10mm)	<b>Yule Gray 7102</b> Solid Core (10mm)	<b>Kandia Black 7103</b> Solid Core (10mm)
<b>Oak 1 7301</b> Solid Core (10mm)	<b>Oak 2 7302</b> Solid Core (10mm)			

HPL BLACK-EDGE FINISHES

<b>Black</b> Black-edge (10 & 12mm)	<b>White</b> Black-edge (10 & 12mm)	<b>Ecru</b> Black-edge (10 & 12mm)

DEKTON CERAMIC SURFACES

<b>Entzo</b> Dekton (12mm)	<b>Danae</b> Dekton (12mm)	<b>Kelya</b> Dekton (12mm)

GLASS SURFACES

<b>Glass</b> (10mm)

HPL EDGES

**A 10mm HPL**

**B 10mm HPL**

**C 10mm HPL**

\*Dekton's table tops are not available for collapsible table bases.  
\*Los tableros Dekton no están disponibles para pies de mesa abatibles.



**DELTA** table base h: 50 cm



Ø62x50 cm - Ø24½"x19¾"  
 4 ud - 16,4 kg 0,11 m³ - 36,28 lb 4,06 ft³

Available table tops  
Tableros disponibles

- Ø50 cm Ø19¾" 50 x 50 cm 19¾" x 19¾"
- Ø59 cm Ø23¾" 59 x 59 cm 23¾" x 23¾"
- Ø69 cm Ø27¼" 59 x 59 cm 23¾" x 23¾"

**DELTA** table base h: 73 cm



Ø62x73 cm - Ø24½"x28¾"  
 4 ud - 16,6 kg 0,13 m³ - 10,97 lb 4,56 ft³

- Ø50 cm Ø19¾" 50 x 50 cm 19¾" x 19¾"
- Ø59 cm Ø23¾" 59 x 59 cm 23¾" x 23¾"
- Ø69 cm Ø27¼" 59 x 59 cm 23¾" x 23¾"

**DELTA** table base h: 105 cm



Ø62x105 cm - Ø24½"x41¾"  
 4 ud - 20,3 kg 0,11 m³ - 15,51 lb 4,06 ft³

- Ø50 cm Ø19¾" 50 x 50 cm 19¾" x 19¾"
- Ø59 cm Ø23¾" 59 x 59 cm 23¾" x 23¾"

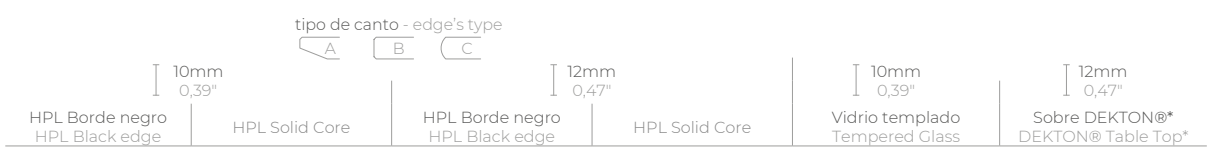

- Ø50 cm - Ø19¾"  
2 ud - 5,6 kg 0,01 m³ - 12,3 lb 0,35 ft³
- Ø59 cm - Ø23¾"  
2 ud - 7,8 kg 0,01 m³ - 17,2 lb 0,35 ft³
- Ø69 cm - Ø27¼"  
2 ud - 10,6 kg - 0,02 m³ - 23,3 lb 0,70 ft³

- 50x50 cm - 19¾"x19¾"  
2 ud - 7 kg 0,01 m³ - 15,4 lb 0,35 ft³
- 59x59 cm - 23¾"x23¾"  
2 ud - 9,8 kg 0,01 m³ - 21,6 lb 0,35 ft³

**HPL SOLID CORE FINISHES**

**HPL BLACK-EDGE FINISHES**

--	--	--

**DEKTON CERAMIC SURFACES**

--	--	--

**GLASS SURFACES**

--

**HPL EDGES**

A 10mm HPL

B 10mm HPL

C 10mm HPL

\*Dekton's table tops are not available for collapsible table bases.  
 \*Los tableros Dekton no están disponibles para pies de mesa abatibles.

**FIESTA** 120cm counter with working area.

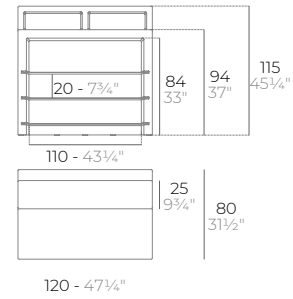

1 ud - 52 kg 1,23 m<sup>3</sup> - 114,6 lb 43,3 ft<sup>3</sup>

- Optional.
- 2 HPL Shelves Set  
Set de 2 estantes HPL
  - HPL Solid Core - Counter Top  
Cubre Barra HPL Solid Core
  - HPL Black Edge - Counter Top  
Cubre Barra HPL Borde Negro
  - 8 Caster Set  
Set 8 ruedas ø40 mm
  - Bluetooth Sound System Pack 200W

**FIESTA** 180cm counter.

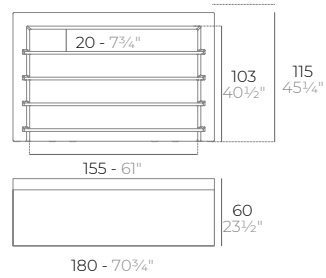

1 ud - 65,5 kg 1,48 m<sup>3</sup> - 144,3 lb 52,2 ft<sup>3</sup>

- Optional.
- 2 HPL Shelves Set  
Set de 2 estantes HPL
  - HPL Solid Core - Counter Top  
Cubre Barra HPL Solid Core
  - HPL Black Edge - Counter Top  
Cubre Barra HPL Borde Negro
  - 8 Caster Set  
Set 8 ruedas ø40 mm
  - Bluetooth Sound System Pack 200W

**FIESTA** curved counter.

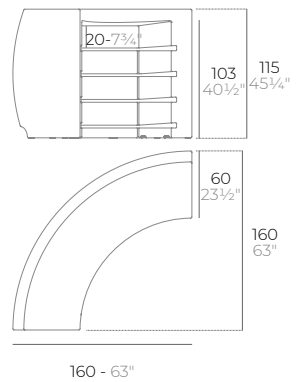

1 ud - 75,9 kg 2,94 m<sup>3</sup> - 167,4 lb 104 ft<sup>3</sup>

- Optional.
- 2 HPL Shelves Set  
Set de 2 estantes HPL
  - HPL Solid Core - Counter Top  
Cubre Barra HPL Solid Core
  - HPL Black Edge - Counter Top  
Cubre Barra HPL Borde Negro
  - 8 Caster Set  
Set 8 ruedas ø40 mm
  - Bluetooth Sound System Pack 200W

SETTING EXAMPLES - EJEMPLOS DE CONFIGURACIÓN

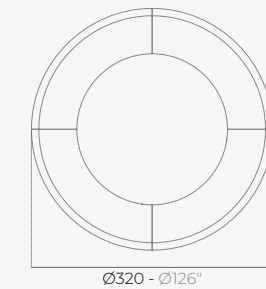

4 x 56002 Barra curva - Curved counter

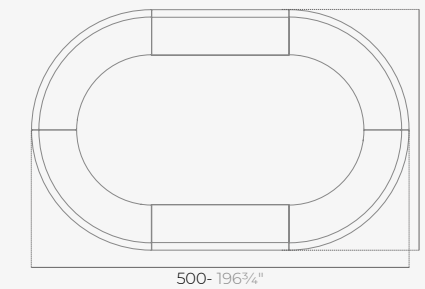

2 x 56001 180 Barra - 180 Counter  
4 x 56002 Barra curva - Curved counter

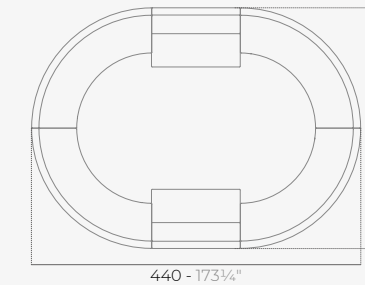

2 x 56023 120 Barra - 120 Counter  
4 x 56002 Barra curva - Curved counter

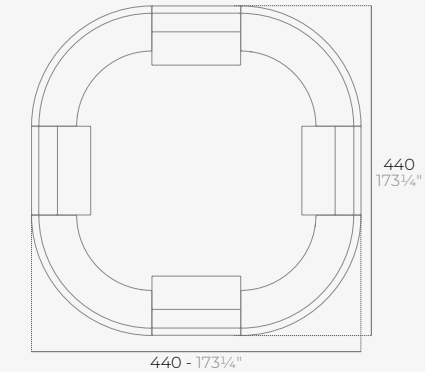

4 x 56023 120 Barra - 120 Counter  
4 x 56002 Barra curva - Curved counter

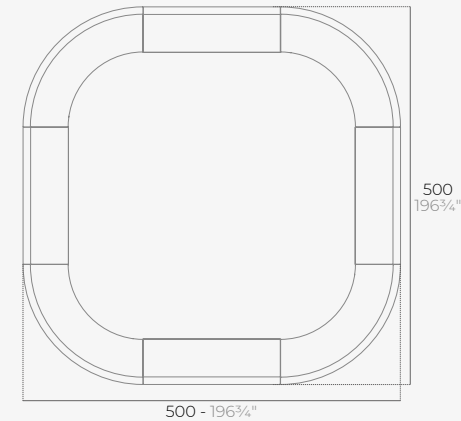

4 x 56001 180 Barra - 180 Counter  
4 x 56002 Barra curva - Curved counter

Básico / Basic	Lacado / Lacquered	LED Blanco / White	LED RGBW Cable / Cable	Batería / Battery	LED RGBW DMX* Cable / Cable	Batería / Battery
----------------	--------------------	-----------------------	---------------------------	-------------------	--------------------------------	-------------------

**FAZ center counter**

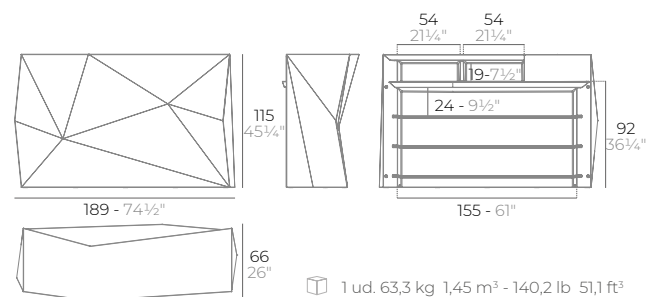

- Optional.
- 2 HPL Shelves Set**  
Set de 2 estantes HPL
- HPL Solid Core - Counter Top**  
Cubre Barra HPL Solid Core
- HPL Black Edge - Counter Top**  
Cubre Barra HPL Borde Negro
- 8 Caster Set**  
Set 8 ruedas ø40 mm
- Bluetooth Sound System Pack 200W**

Básico / Basic	Lacado / Lacquered	LED Blanco / White	LED RGBW Cable / Cable	Batería / Battery	LED RGBW DMX* Cable / Cable	Batería / Battery
----------------	--------------------	-----------------------	---------------------------	-------------------	--------------------------------	-------------------

**FAZ center counter with ice bucket**

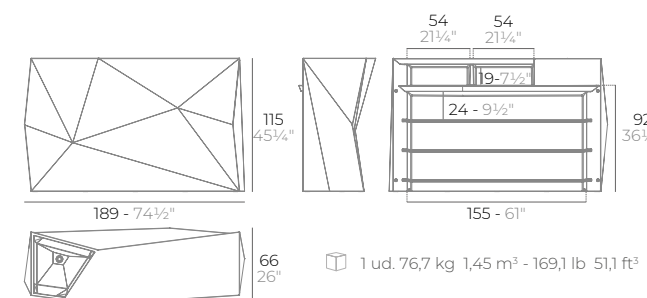

- Optional.
- 2 HPL Shelves Set**  
Set de 2 estantes HPL
- HPL Solid Core - Counter Top**  
Cubre Barra HPL Solid Core
- HPL Black Edge - Counter Top**  
Cubre Barra HPL Borde Negro
- 8 Caster Set**  
Set 8 ruedas ø40 mm
- Bluetooth Sound System Pack 200W**

**FAZ side counter**

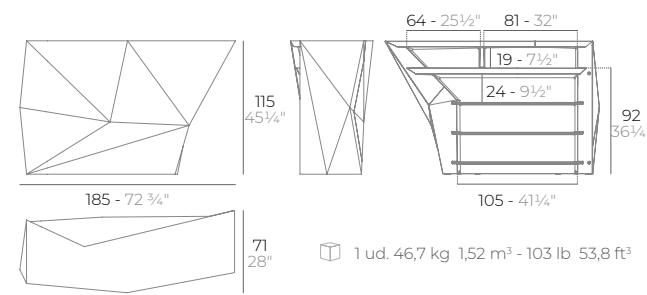

- Optional.
- 2 HPL Shelves Set**  
Set de 2 estantes HPL
- HPL Solid Core - Counter Top**  
Cubre Barra HPL Solid Core
- HPL Black Edge - Counter Top**  
Cubre Barra HPL Borde Negro
- 8 Caster Set**  
Set 8 ruedas ø40 mm
- Bluetooth Sound System Pack 200W**

**FAZ corner counter**

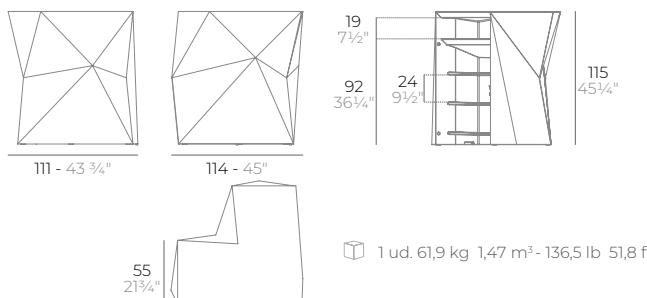

- Optional.
- 2 HPL Shelves Set**  
Set de 2 estantes HPL
- HPL Solid Core - Counter Top**  
Cubre Barra HPL Solid Core
- HPL Black Edge - Counter Top**  
Cubre Barra HPL Borde Negro
- 8 Caster Set**  
Set 8 ruedas ø40 mm
- Bluetooth Sound System Pack 200W**

**SETTING EXAMPLES - EJEMPLOS DE CONFIGURACIÓN**

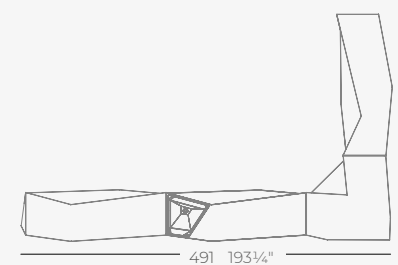

- 1 x 54113 Barra Central Counter Bar
- 1 x 54114 Barra Central Cubitera Counter Ice Bucket
- 1 x 54112 Barra Esquina Corner Bar
- 1 x 54111 Barra Lateral Single Bar

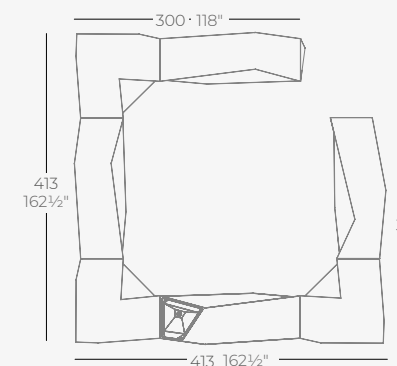

- 2 x 54113 Barra Central Counter Bar
- 1 x 54114 Barra Central Cubitera Counter Ice Bucket
- 3 x 54112 Barra Esquina Corner Bar
- 1 x 54111 Barra Lateral Single Bar

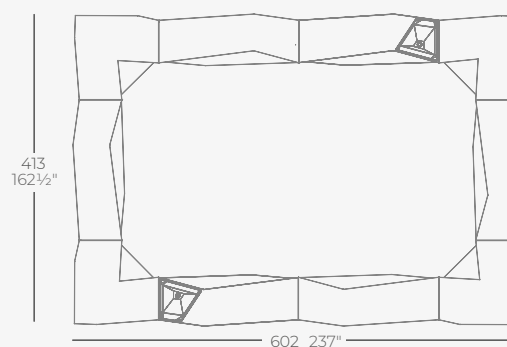

- 4 x 54113 Barra Central Counter Bar
- 2 x 54114 Barra Central Cubitera Counter Ice Bucket
- 4 x 54112 Barra Esquina Corner Bar

Básico / Basic     Lacado / Lacquered    LED Blanco / White    LED RGBW Cable / Cable    Bateria / Battery    LED RGBW DMX\* Cable / Cable    Bateria / Battery

**VELA double counter.**

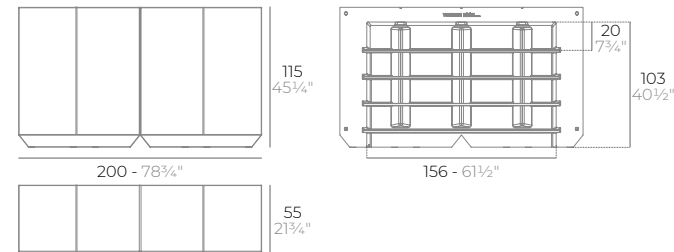

1 ud. 72,6 kg 1,44 m<sup>3</sup> - 160,1 lb 50,8 ft<sup>3</sup>

- Optional.
- 2 HPL Shelves Set  
Set de 2 estantes HPL
  - HPL Solid Core - Counter Top  
Cubre Barra HPL Solid Core
  - HPL Black Edge - Counter Top  
Cubre Barra HPL Borde Negro
  - 8 Caster Set  
Set 8 ruedas ø40 mm
  - Bluetooth Sound System Pack 200W

Básico / Basic     Lacado / Lacquered    LED Blanco / White    LED RGBW Cable / Cable    Bateria / Battery    LED RGBW DMX\* Cable / Cable    Bateria / Battery

**VELA catering counter.**

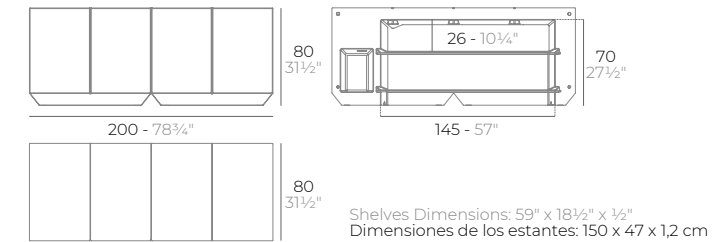

1 ud. 72,1 kg 1,63 m<sup>3</sup> - 159 lb 57,4 ft<sup>3</sup>

- Optional.
- 2 HPL Shelves Set  
Set de 2 estantes HPL
  - HPL Solid Core - Counter Top  
Cubre Barra HPL Solid Core
  - HPL Black Edge - Counter Top  
Cubre Barra HPL Borde Negro
  - 8 Caster Set  
Set 8 ruedas ø40 mm
  - Bluetooth Sound System Pack 200W

**VELA single counter**

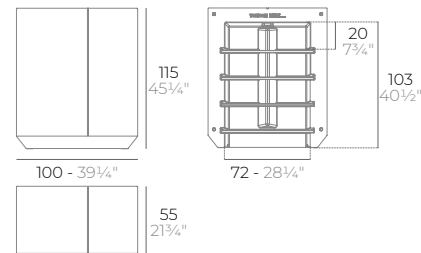

1 ud. 40,6 kg 0,73 m<sup>3</sup> - 89,6 lb 25,9 ft<sup>3</sup>

- Optional.
- 2 HPL Shelves Set  
Set de 2 estantes HPL
  - HPL Solid Core - Counter Top  
Cubre Barra HPL Solid Core
  - HPL Black Edge - Counter Top  
Cubre Barra HPL Borde Negro
  - 8 Caster Set  
Set 8 ruedas ø40 mm
  - Bluetooth Sound System Pack 200W

**VELA catering counter with ice bucket.**

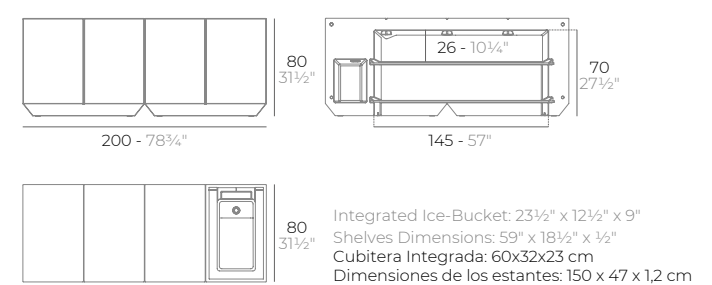

1 ud. 0,1 kg 1,63 m<sup>3</sup> - 0,2 lb 57,4 ft<sup>3</sup>

- Optional.
- 2 HPL Shelves Set  
Set de 2 estantes HPL
  - HPL Solid Core - Counter Top  
Cubre Barra HPL Solid Core
  - HPL Black Edge - Counter Top  
Cubre Barra HPL Borde Negro
  - 8 Caster Set  
Set 8 ruedas ø40 mm
  - Bluetooth Sound System Pack 200W

**VELA counter's door with hinge.**



1 ud. 20,9 kg 0,5 m<sup>3</sup> - 46,1 lb 17,6 ft<sup>3</sup>

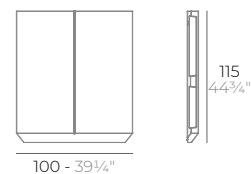

MARQUIS table lamp.



Europe plug  
USA plug

Europe plug  
USA plug

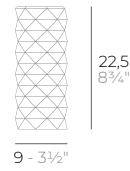

GATSBY CYLINDER. Table lamp.



Europe plug  
USA plug

Europe plug  
USA plug

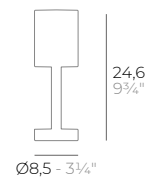

GATSBY PRISMA. Table lamp.



Europe plug  
USA plug

Europe plug  
USA plug

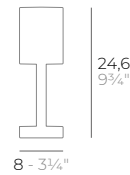

12 hours of battery \*

5 colors of light \*

3 light intensities

tactile switch

wireless DMX system \*

The Table Lamps are preset with a DMX address. (Channels 13 / 14 / 15 / 16)  
If you want to create zones and control them separately you must communicate this before confirming the order.  
DMX Transmitter Required (not included).

Las lámparas de mesa vienen con una dirección DMX asignada. (Canales 13 / 14 / 15 / 16)  
Para crear zonas y controlarlas independientemente, es necesario asignar otras direcciones DMX a las lámparas de mesa. Debe indicarse en la confirmación del pedido.  
Controlador DMX Necesario (no incluido).

AFRICA CHAIR  
65036

AFRICA ARMCHAIR  
65005

BROOKLYN CHAIRS  
65037, 65038

DELTA CHAIR  
66026

FAZ CHAIRS  
(WOOD, CLEAR, INOX.)  
54294, 54063, 54045, 54295,  
54062, 54044

IBIZA CHAIR  
65040

IBIZA ARMCHAIR  
65041

IBIZA CHAIR WITH ARMS  
65044

IBIZA LOUNGE CHAIR  
65039

KES CHAIRS  
64018, 64017

KIMONO CHAIR  
54299

LA PEDRERA  
65004

LOVE CHAIR  
65042

QUARTZ CHAIRS  
54194, 54195

SABINAS ARMCHAIR  
45012

SOLID CHAIR  
55024

SOLID ARMCHAIR  
55027

SOLID LOUNGE CHAIR  
55023

SOLID SOFA  
55022

SPRITZ ARMCHAIR  
56017

SPRITZ CHAIR &  
CHAIR WITH ARMS  
56016, 56015

SPRITZ LOUNGE CHAIR  
56024

SPRITZ SOFA  
56025

SPRITZ STOOL  
56019, 56020

SPRITZ SUN LOUNGER  
56027

VASES ARMCHAIR  
47070

VOXEL CHAIR  
51033

VOXEL ARMCHAIR  
51031

WALLSTREET ARMCHAIR  
65006



# COLORS, FABRICS & FINISHES

PRODUCT COLORS	__ 188
TABLE TOPS	__ 192
OUTDOOR UPSHOLSTERY	__ 194
PRODUCTS AND FINISHES	__ 204
TECHNICAL INFORMATION	__ 216

**Basic.** Básico.

**Lacquered.** Lacado.



White 2001



Steel 2005



Anthracite 2006



Black 2002



Ecreu 2003



Crema 2017



Taupé 2004



Bronze 2008



Ice 2101



Beige 2007



Modo Green 2016



Khaki 2009



Notte Blue 2018



Purjai Red 2015



Red 2014



Orange 2019



White 3101



Steel 3105



Anthracite 3106



Black 3102



Ecreu 3103



Taupé 3104



Modo Green 3116



Khaki 3109



Crema 3117



Beige 3107



Champagne 3115



Bronze 3108



Notte Blue 3118



Purjai Red 3113



Red 3114



Orange 3111

**Basic injection.**  
Básico inyección.



White 4001



Ecru 4003



Tortora 4004



Gray 4005



Navy 4013



Almond 4017



Pickle 4018



Melon 4015



Red 4014



Mostaza 4016



Bronze 4008



Black 4002



Crema 4021



Modo Green 4020



Purjai Red 4019



Notte Blue 4022

**Clear PC.**  
PC translúcido.



Cristal 4101



Fume 4103



Zaphire 4106



Amber 4102



Opaque White PC 4105



Opaque Black PC 4104

**Powder Coated Aluminium.**  
Aluminio lacado al horno.



White 5001



British Gray 5038



Traffic Gray 5037



Black 5002



Ecru 5003



Crema 5036

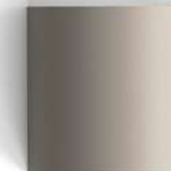

Castoro Fiber 5035



Cacao 5033



Notte Blue 5030



Modo Green

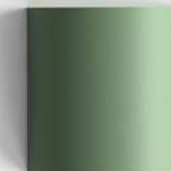

Pickle 5020

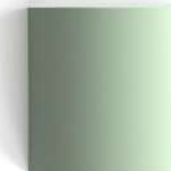

Almond 5019



Red 5014



Purjai Red 5031



Melon 5018



Mostaza 5016

**Ash Wood.**   
Madera de fresno.



Wood 1 9001



Wood 2 9002



Natural Teak 9003



Weathered Teak 9004

**Teak Wood.**   
Madera de Teca



TABLE  
TOPS

**HPL Solid Core.**  
HPL Solid Core



**White 7000**  
Solid Core  
(10 & 12mm)



**Castoro Fiber 7006**  
Solid Core  
(10mm)



**Traffic Gray 7008**  
Solid Core  
(10mm)



**Modo Green 7003**  
Solid Core  
(10mm)

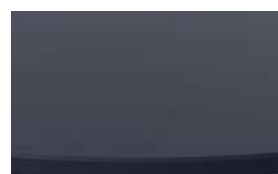

**Notte Blue 7001**  
Solid Core  
(10mm)



**Crema 7007**  
Solid Core  
(10mm)



**Piombo Gray 7005**  
Solid Core  
(10mm)



**British Gray 7009**  
Solid Core  
(10mm)



**Cacao 7004**  
Solid Core  
(10mm)



**Purjai Red 7002**  
Solid Core  
(10mm)



**Marmo Canova 7101**  
Solid Core  
(10mm)



**Yule Brown 7105**  
Solid Core  
(10mm)



**Pulpis Gray 7104**  
Solid Core  
(10mm)



**Yule Gray 7102**  
Solid Core  
(10mm)



**Kandia Black 7103**  
Solid Core  
(10mm)



**Oak 1 7301**  
Solid Core  
(10mm)



**Oak 2 7302**  
Solid Core  
(10mm)

**HPL Black Edge.**  
HPL borde negro.



**Black 7203**  
Black-edge  
(10 & 12mm)



**White 7201**  
Black-edge  
(10 & 12mm)



**Ecrú 7202**  
Black-edge  
(10 & 12mm)

**Glass.**  
Vidrio.



**Glass 8000**  
(10mm)



**White Opaque Glass 8001**  
(Only available for coffee tables)



**Black Opaque Glass 8002**  
(Only available for coffee tables)



**Bronze Smoked Glass 8003**  
(Only available for coffee tables)

**DECKTON®**  
Ceramic Surfaces.



**Entzo 6003**  
Dekton  
(12mm)



**Danae 6002**  
Dekton  
(12mm)



**Kelya 6001**  
Dekton  
(12mm)

**NAUTICAL 1A**

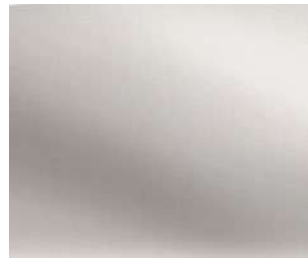

White 1100



Steel 1101

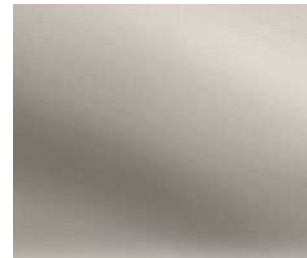

Taupe 1102



Black 1105



Natural 1111



Crema 1103



Bronze 1104

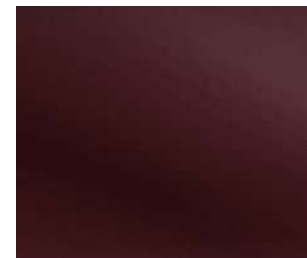

Purjai Red 1106



Notte Blue 1114



Forest 1112



Orange 1113



Red 1108

**SILVERTEX 1B**



White 1219



Steel 1208



Taupe 1209



Anthracite 1210



Natural 1220



Beige 1211



Ecrú 1221



Bronze 1214



Kaki 1218



Forest 1224



Notte Blue 1222



Purjai Red 1223

**HERITAGE 1B**



Papyrus 1530



Granite 1531

**CICO 1C**



Limestone 1701



Gravel 1702



Greywacke 1704



Onix 1705

**SAVANE 1B**



White 1501



Whisper 1502



Tornado 1503



Sandstone 1703



Cranberry 1707



Blueberry 1706

**CREVIN 1B**

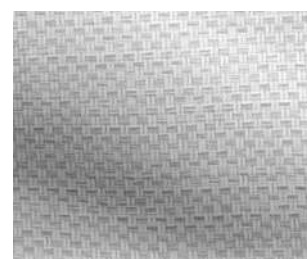

White 1308



Steel 1309



Taupe 1310



Anthracite 1311

**SIESTA 1C**



Siesta 1810



Siesta 1811



Siesta 1812



Siesta 1813



Blue 1301



Deep Blue 1302

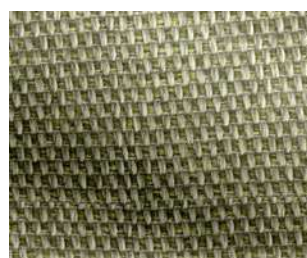

Lemongrass 1303



Melon 1304

**ACAPULCO 1C**



Acapulco 1801



Acapulco 1802



Acapulco 1803



Acapulco 1804



Acapulco 1806



Acapulco 1805

**IKON 1C**

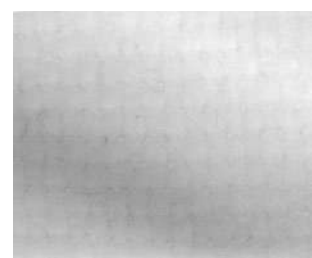

Ikon 1830

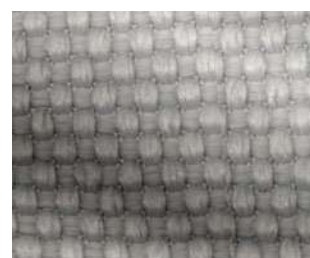

Ikon 1831



Ikon 1832



Ikon 1833



Ikon 1834



Ikon 1835

**VELUM**

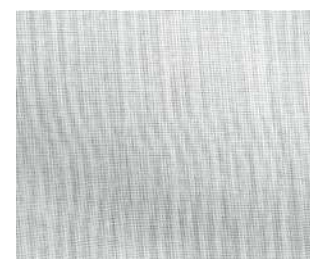

White 1540

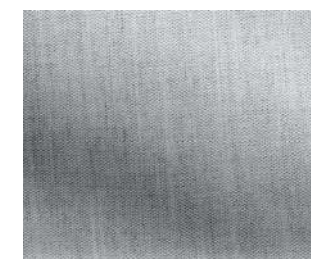

Steel 1541



Steel 1902



Ecrú / Taupe 1904



Bronze 1905



Black 1903

**BATYLINE**

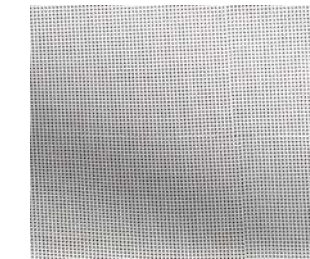

White 1901

**ROOF FABRIC**

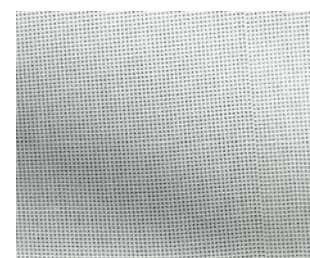

White 1910



Steel 1911



Ecrú 1912



Bronze 1913

**ROOF ROPE**



Snow 1201



Ecrú 1202



Gray 1203



Taupe 1204

**KROLLET 2A**



Krollet 1921



Krollet 1922



Krollet 1923



Krollet 1924



Krollet 1925



Krollet 1926

**HYGGUE 2B**



Hygge 1080



Hygge 1081



Hygge 1082

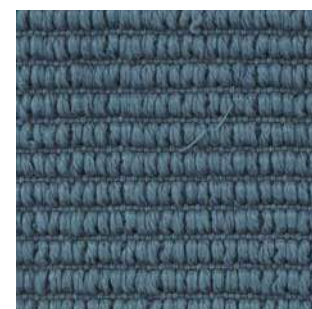

Hygge 1083

**VARM 2B**



Varm 1060



Varm 1061



Varm 1062



Varm 1063



Varm 1064



Varm 1065



Varm 1066



Varm 1067



Varm 1068



Varm 1069



Varm 1070



Varm 1071



Berry 1021

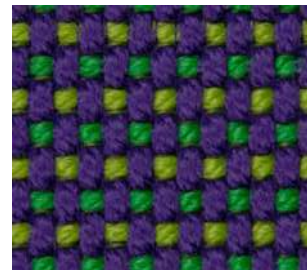

Masai 1018

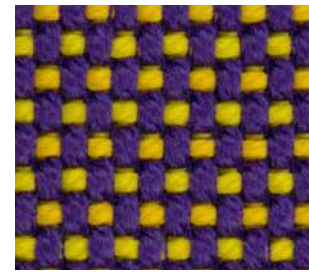

Sunset 1020

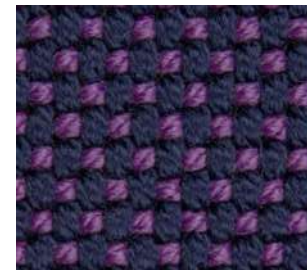

Noa 1026



Pruna 1045

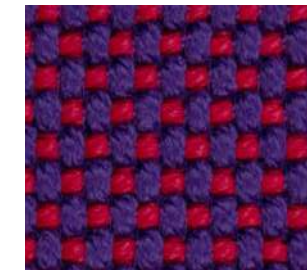

Vera 1019

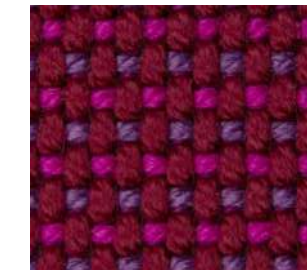

Afrodita 1013



Grana 1046

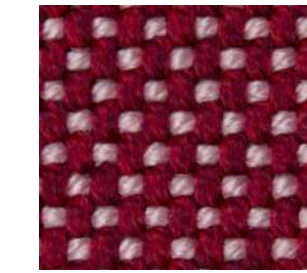

Dahlia 1035

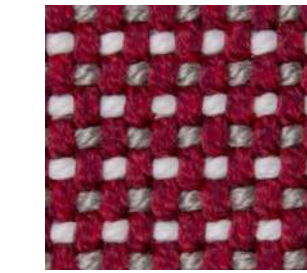

Bacco 1034



Amatista 1011



Galan 1025

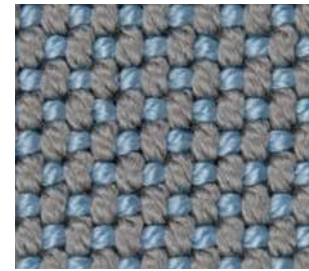

Perla 1006

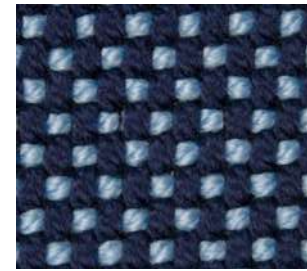

Eclipse 1023

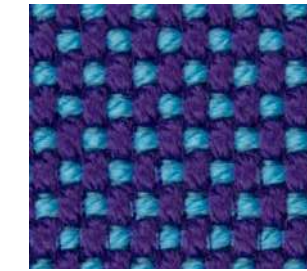

Calipso 1017



Wine 1012

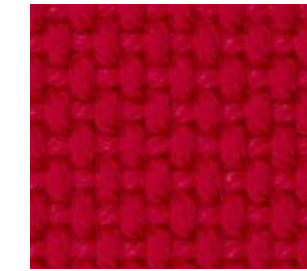

Foc 1052

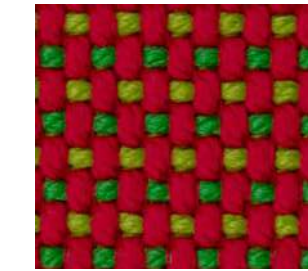

Hestia 1014



Chocolate 1050

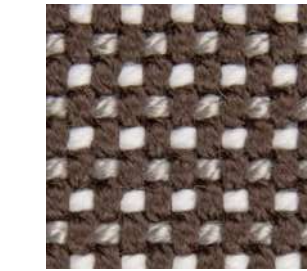

Moka 1010



Night 1024



Ultramar 1002

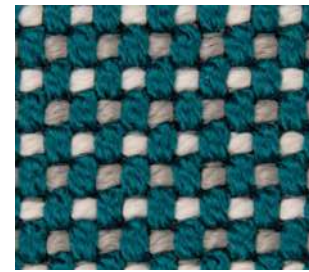

Niord 1015

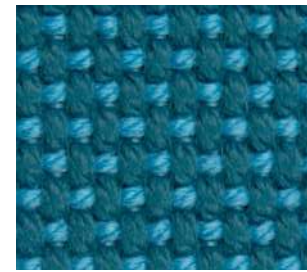

Aquamarina 1003

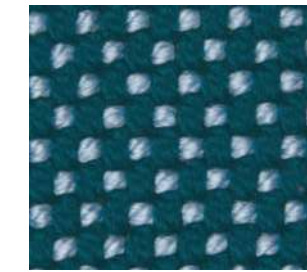

Esmeralda 1016



Ecrú 1047

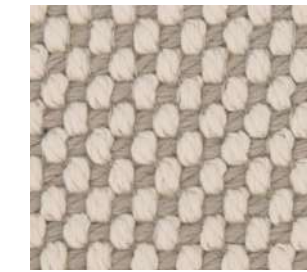

Desert 1033

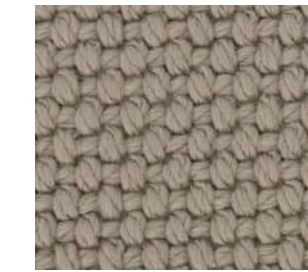

Taupé 1048

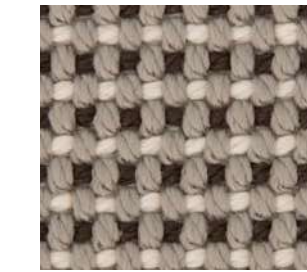

Terra 1039



Duna 1009

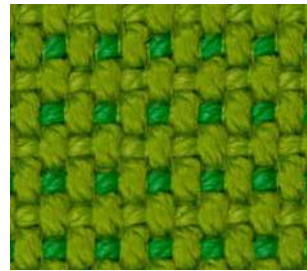

Bosc 1029



Artemisa 1027

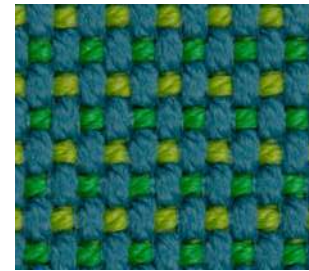

Oceano 1005

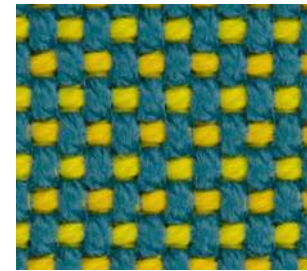

Caribe 1004

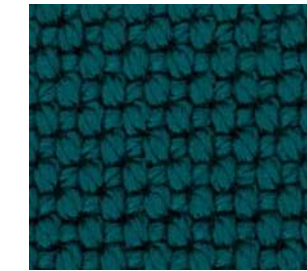

Turquoise 1053

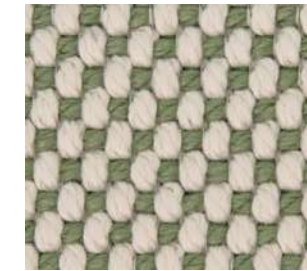

Oasis 1007



Moon 1040

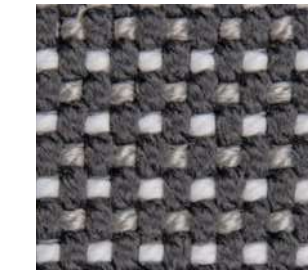

Granito 1008

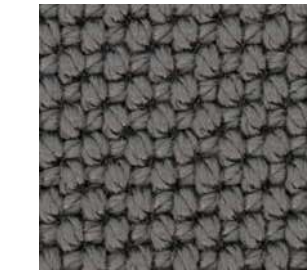

Grey 1043

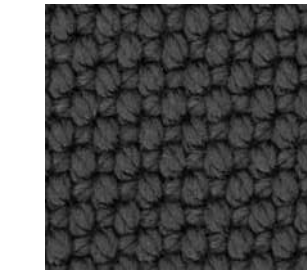

Anthracite 1044



Aguacate 1028

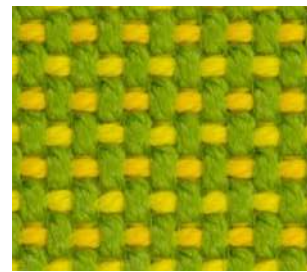

Lima 1030

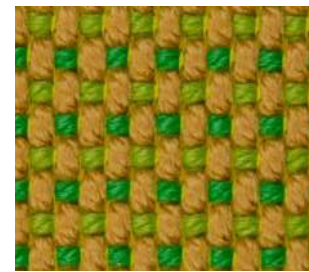

Delhi 1038

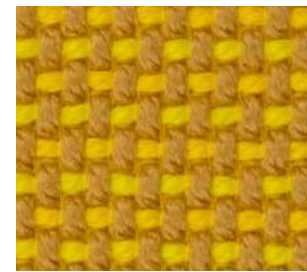

Oro 1031

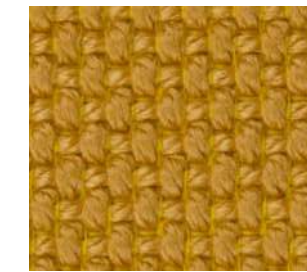

Ocre 1051

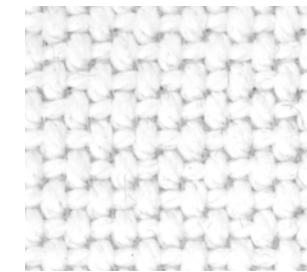

Snow 1041

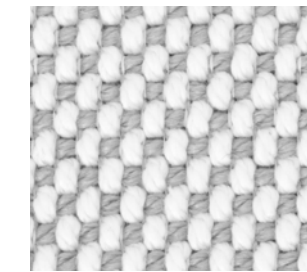

Iceberg 1037

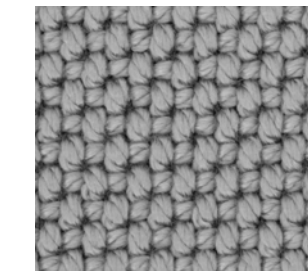

Steel 1042











COLORES. COLORS

COLORES. COLORS

TEJIDOS. FABRICS.

	BÁSICO BASIC														LACADO LACQUERED														INYECCIÓN INJECTION														METAL METAL														HPL	VIDRIO GLASS		DEKTON®	WOOD WOOD		Group 1		Group 2																																																		
	White	Black	Bronze	Steel	Antracite	ModoGreen	Purjaj Red	Beige	Ecru	Crema	Taupe	Khaki	Noite Blue	Ice	Red	Orange	White	Black	Bronze	Steel	Antracite	ModoGreen	Purjaj Red	Beige	Ecru	Crema	Taupe	Khaki	Noite Blue	Champange	Red	Orange	White	Ecru	Black	Red	Melon	Mustard	Pickle	Almond	Noite Blue	Purjaj Red	Modo Green	Cray	Crema	Tortora	Bronze	White Glossy	Black Glossy	Cristal Clear	Ambar clear	Furné clear	Zaphire clear	Milos	Cala	Mantia	White	Ecru	Black	Red	Melon	Mustard	Picle	Almond	Noite Blue	Purjaj Red	Modo Green	Traffic Cray	Crema	Castoro Fiber	British Cray	Cacao	SOLID CORE	BLACK EDGE	Ice	Bronze Smoked	White Opaque	Black Opaque	DEKTON TABLE TOP	WOOD1	WOOD2	TEAK	WEATHERED	TA	TB	TC	DRALÓN	SUNVISON	BATYLINE	ROPES	VELLUM																								
Vela Lamps																																																																																																																			
Vela Bar	●	●	●	●	●	●	●	●	●	●	●	●	●	●	●	●	●	●	●	●	●	●	●	●	●	●	●	●	●	●	●	●	●																																																																																		
Venus Planters	●	●	●	●	●	●	●	●	●	●	●	●	●	●	●	●	●	●	●	●	●	●	●	●	●	●	●	●	●	●	●	●	●																																																																																		
Vertex Collection	●	●	●	●	●	●	●	●	●	●	●	●	●	●	●	●	●	●	●	●	●	●	●	●	●	●	●	●	●	●	●	●	●																																																																																		
Vertex Tables	●	●	●	●	●	●	●	●	●	●	●	●	●	●	●	●	●	●	●	●	●	●	●	●	●	●	●	●	●	●	●	●	●																																																																																		
Vineyard Collection																																																																																																																			
Vineyard Daybed + fabric roof																																																																																																																			
Vineyard Daybed + woven rope top																																																																																																																			
Voxel Chair																●	●			●													○	●	●	●					●												○	●	●	●	●	●	●	●	●	●	●	●	●	●	●	●	●	●	●	●	●																																										
Voxel Mini																																	○	●	●	●					●																																																																										
Voxel Sun Lounger																																	○	●							●																																																																										
Wall Street Collection																●	●			●													○	●	●	●																																																																															
Wing Collection	●	●	●	●	●	●	●	●	●	●	●	●	●	●	●	●	●	●	●	●	●	●	●	●	●	●	●	●	●	●	●	●	●																																																																																		

# TECHNICAL INFORMATION



# EN | TECHNICAL INFORMATION

## Finishes & Extras Furniture

All our products are suitable for indoor and outdoor use.

### BASIC

Matte finish.

### LACQUERED

High gloss lacquered.

### TWO-TONE LACQUERED

High gloss lacquered finish in two different colors. To avoid possible damage we do not recommend stacking the product.

### EXTRAS / OPTIONS

### WHITE LED

White internally lit unit with LED technology. Available only in matte ice white finish.

### RGBW LED

Unit with internal lighting with RGBW LED technology and remote control unit for switching colors. Available only in matte ice white finish. Remote control included.

### RGBW LED DMX

Unit with internal lighting with RGBW LED technology and remote control unit for switching colors. Also controlled by DMX-1024 (wireless), enabling communication between one or more products simultaneously via the DMX transmitter (not included). There are two options to choose from: Professional XLR DMX and Home WIFI DMX.

Both options are available in various configurations:

1\* DMX Wireless Standard Configuration.

2\* DMX Wireless Customized Configuration.

### WITH BATTERY

### RGBW LED BATTERY

Unit with internal lighting with battery-powered RGBW LED technology. Includes charger and remote control for switching colors and charger. Available only in matte ice white finish.

### RGBW LED DMX BATTERY

Unit with internal lighting with RGBW LED technology supplied by a battery (includes charger and remote control unit for switching colors). Also controlled by DMX-1024 (wireless), enabling communication between one or more products simultaneously via the DMX transmitter (not included). There are two options to choose from: Professional XLR DMX and Home WIFI DMX.

Both options can have 2 different configurations:

1\* DMX Wireless Standard Configuration.

2\* DMX Wireless Customized Configuration.

## Finishes & Extras Nanos

Mini products made out of polyethylene resin. Item suitable for indoor and outdoor use.

### NANO BASIC

Matte finish. The Ice matte finish can be illuminated.

### NANO LACQUERED

High gloss lacquered.

### EXTRAS / OPTIONS

### NANO WHITE LED

Compact ice-colored unit with white LED lighting. For interior use only.

### NANO RGBW LED WITH BATTERY (CHRISMY)

Compact ice-colored unit with white LED lighting. For interior use only. Charger and batteries included. (Includes remote control unit for changing color).

## Finishes & Extras Pots & Planters

Pots and planters made out of a single walled polyethylene resin. Item suitable for outdoor use.

### SIMPLE

Matte finish.

### LACQUERED SIMPLE

High gloss lacquered.

### BASIC

Matte finish.

The Ice matte finish can be illuminated.

### SELF-WATERING SYSTEM

This system provides the plant with water whenever the plant needs it, this mechanism has an indicator that alerts us when the plant needs to be watered.

Available in matte and lacquered finishes only for indoor use.

Not recommended for outdoors. Due to the drainage, the indicator will not work properly.

### LACQUERED

High gloss lacquered.

This self-watering system is included in the basic finish collections.

### EXTRAS / OPTIONS

### WHITE LED

White internally lit unit with LED technology. Available only in matte ice white finish.

### RGBW LED

Unit with internal lighting with RGBW LED technology and remote control unit for switching colors. Available only in matte ice white finish. Remote control included.

### RGBW LED DMX

Unit with internal lighting with RGBW LED technology and remote control unit for switching colors. Also controlled by DMX-1024 (wireless), enabling communication between one or more products simultaneously via the DMX transmitter (not included). There are two options to choose from: Professional XLR DMX and Home WIFI DMX.

Both options are available in various configurations:

1\* DMX Wireless Standard Configuration.

2\* DMX Wireless Customized Configuration.

### WITH BATTERY

### RGBW LED BATTERY

Unit with internal lighting with battery-powered RGBW LED technology. Includes charger and remote control for switching colors and charger. Available only in matte ice white finish.

### RGBW LED DMX BATTERY

Unit with internal lighting with RGBW LED technology supplied by a battery (includes charger and remote control unit for switching colors). Also controlled by DMX-1024 (wireless), enabling communication between one or more products simultaneously via the DMX transmitter (not included). There are two options to choose from: Professional XLR DMX and Home WIFI DMX. (Remote control included).

Both options can have 2 different configurations:

1\* DMX Wireless Standard Configuration.

2\* DMX Wireless Customized Configuration.

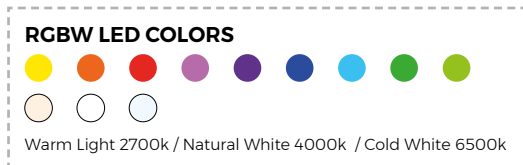

## Bluetooth Sound System

Connect your smartphone or tablet via Bluetooth to the built in speakers.

- Sound systems 200W Dual component.

- Bluetooth Ready v.4.0.

- Input: AUX Jack 3,5 mm.

- USB Charger for portable gadget - Output 5V= 1500mA

## Lightining

### POWER SUPPLY

### LED WHITE

- Simple color LEDs 4500 K

- 720 - 2800 LM Max. (Models subject to availability)

- 12 - 72 W Max. (Models subject o availability)

- Power supply: Mean Well / Class 2 / IN: 100-240V AC / 50-60Hz

- IEE: Class A

- IP65 / applicable for wet areas.

- Ta: 40°C

- 4-5 m. white cable Ho5RN-F 2G1 mm2 + Plug (EU - AUS - UK) 

- 4-5 m. white cable SJTW - 2 x AWG18 + Plug (USA) 

- CE / RoHS / UL



### NANO LED WHITE

- Simple color LEDs 4500 K

- 40 LM

- 14 W Max.

- Wall Power supply: IN: 100-240V AC / 50-60Hz

- IEE: Class A

- IP20 / indoor use only

- Ta: 35°C

- 2 Meters transparent cable with hand switch + EU Plug 

- CE / RoHS

### RGBW LED

- Multicolor LEDs RGBW

- Controller RF433 Mhz / 10-15 meters range

- 450 - 1100 LM Max. (Models subject to availability)

- 16 - 72 W Max. (Models subject to availability)

- Power supply: Mean Well / Class 2 / IN: 100-240V AC / 50-60Hz

- IEE: Class A

- IP65 / applicable for wet areas.

- Ta: 40°C

- 4-5 m. white cable Ho5RN-F 2G1 mm2 + Plug (EU - AUS - UK) 

- 4-5 m. white cable SJTW - 2 x AWG18 + Plug (USA) 

- CE / RoHS / UL



### RGBW LED DMX

- Multicolor LEDs RGBW

- Controller RF433 Mhz / 10-15 meters range

- DMX 1024 decoder / 2.4Ghz wireless signal/ compatible with IOS or Android & Professional Installations.

- DMX 1024 decoder / 2.4 Ghz wireless signal.

-Home WiFi DMX wireless controller, compatible with IOS and Android (not included)

-Professional DMX wireless controller, connector XLR (not included)

- 450 - 1100 LM Max. (Models subject to availability)

- 12 - 72 W Max. (Models subject to availability)

- Power supply: Mean Well / Class 2 / IN: 100-240V AC / 50-60Hz

- IEE: Class A

- IP65 / applicable for wet areas.

- Ta: 40°C

- 4-5 m. white cable Ho5RN-F 2G1 mm2 + Plug (EU - AUS - UK) 

- 4-5 m. white cable SJTW - 2 x AWG18 + Plug (USA) 

- CE / RoHS / UL



### BATTERY

### BATTERY RGBW LED

- Multicolor LEDs RGBW

- Controller RF433 Mhz / 10-15 meters range

- 450 - 1100 LM Max. (depending on the model)

- 12 - 72 W Max. (depending on the model)

- Li-ion Battery 5.2.19 Ah (depending on the model) 12V / 6-8 h autonomy / Load 5h - 500 cycles

- Charger: 1.5A - 4A (depending on the model) IN: 100-240V AC / 50-60Hz

- IEE: Class A / CE / RoHS / IP65 (Suitable for wet areas)

- Ta: 40°C

### BATTERY RGBW LED DMX

- Multicolor LEDs RGBW

- Controller RF433 Mhz / 10-15 meters range

- DMX 1024 decoder / 2.4 Ghz wireless signal.

-Home WiFi DMX wireless controller, compatible with IOS and Android (not included)

-Professional DMX wireless controller, connector XLR (not included)

- Li-ion Battery 5.2 - 19 Ah (depending on the model) 12V / 6-8 h autonomy / Load 5h - 500 cycles

- Charger: 1.5A - 4A (depending on the model) IN: 100-240V AC / 50-60Hz

- 1100 LM Max. (Models subject to availability)

- 12 - 72 W Max. (Models subject to availability)

- IEE: Class A / CE / RoHS / IP65 (Suitable for wet areas)

- Ta: 40°C

### BATTERY NANO LED RGBW

- Multicolor LEDs

- Controller RF433 Mhz / 10-15 meters range

- 40 - 100 LM Max.

- 1.5 W Max.

- Li-ion Battery 2 Ah / 5V / 6-8 h autonomy / Load 5h / IN: 100-240V AC / 50-60Hz

- IEE: Class A / CE / RoHS / IP65 (Suitable for wet areas)

- Ta: 40°C

### LED WHITE TABLE LAMPS

- Single LED Warm White 2700k°

- ON/OFF & Dimmer tactile

- 0.8W (Battery) - 3.3 W Max. (Power supply).

- Li-ion Battery 3000 mA 4.2V / 12 h autonomy / Load 4h - 500 cycles

- USB Charger 5v DC 1A / IN: 100-240V AC / 50-60Hz

- Ta: 40°C

- IEE: Class A++ / IP54 / CE

### RGBW LED TABLE LAMPS

- 5 LEDs Colors. (Blue / Fucsia / Amber / Turquoise / Warm White 2700k°)

- ON/OFF & Dimmer tactile

- 0.8W (Battery) - 3.3 W Max. (Power supply).

- Li-ion Battery 3000 mA 4.2V / 12 h autonomy / Load 4h - 500 cycles

- USB Charger 5v DC 1A / IN: 100-240V AC / 50-60Hz

- Ta: 40°C

- IEE: Class A+ / IP54 / CE

### RGBW LED DMX TABLE LAMPS

- 5 LEDs Colors. (Blue / Fucsia / Amber / Turquoise / Warm White 2700k°)

- ON/OFF & Dimmer tactile

- DMX 1024 decoder / 2.4 Ghz wireless signal.

-Home WiFi DMX wireless controller, compatible with IOS and Android (not included)

-Professional DMX wireless controller, connector XLR (not included)

- 0.8W (Battery) - 3.3 W Max. (Power supply).

- Li-ion Battery 3000 mA 4.2V / 12 h autonomy / Load 4h - 500 cycles

- USB Charger 5v DC 1A / IN: 100-240V AC / 50-60Hz

- Ta: 40°C

- IEE: Class A+ / IP54 / CE



# EN | TECHNICAL INFORMATION

## Material Features

### POLYPROPYLENE

- Material: Polypropylene resin with glass fiber , UV stabilizer.
- Process: injection moulding.
- Shock resistant.
- Light weight.
- 100% recyclable.

### POLYETHYLENE

- Material: Resin. Linear low-density poethylene. UL94 HB.
- Process: Rotational Moulding.
- Resistant to UVI. Fattore UV8, equivalent to 8.000 hours of Florida sunlight.
- Resistant to extreme temperatures (-60°C to + 80°C) / (-76°F to 176°F)
- Shock Resistant.
- Light weight
- The planters are easily drilled to make draining holes.
- Recyclable 100%.

### POLYCARBONATE

- Material: Polycarbonate resin. Low viscosity, high strength.
- Process: Injection Moulding.
- Shock Resistant.
- Light weight
- Recyclable 100%.

### ALUMINIUM (TABLE BASE)

- Material: AISI12 (EN AC-44100).
- Process: Cast aluminum.
- Shock Resistant.
- Recyclable 100%.
- Powder coated cast aluminum.

### ALUMINUM (PROFILE)

- Material: 6060 (AlMgSi.3.3206,A96060).
- Process: Aluminum extrusion.
- Shock Resistant.
- Recyclable 100%.
- Lacquered.

### TEAK WOOD

- Premium Indonesian teak is durable and exceptionally resistant to the elements
- Natural Teak weathers to a soft, silver-grey patina over time due to the effects of sun and moisture
- **Please check the web for maintenance and care of teak**

### WEATHERED TEAK WOOD

- Premium Indonesian teak is durable and exceptionally resistant to the elements
- Weathered Teak's hand-applied, wire-brush finish offers an already weathered look
- **Please check the web for maintenance and care of teak**

### PADDED FOAM

Polyurethane foam is suitable for outdoor use and in areas with high humidity.

Perfectly waterproof, high drying capacity, comfortable and easily cleaned.

Properties	Unit	Value	Specifications
Composition	-	100% Polyester	-
Maximum temperature	°C	110.0	±1.0
Manufacturing process	Dry carded and ternal drying		
Recyclability	100%, without additives or binding agents		

Other caractherics:

- It does not absorb or retain moisture.
- It is not affected by mould, insects or rodents.
- It does not cause irritation to the skin or the mucous membranes.

### POLYURETHANE FOAM (UPHOLSTERED FURNITURE)

Furniture made produced with Polyurethane foam injected. The foam has high resilience and durability. The flexible Polyurethane foam is covered with a elastic cellular net that keeps the original product's shape after its use. Prevents fungal and bacterial growth.

Mechanical properties.

- Tensile strength resistance: between 3 & 10 (Kp/cm2)
- Compression resistance: between 1,5 & 9 (Kp/cm2)
- Shear strength resistance: between 1 & 5 (Kp/cm2)
- Modulus of elasticity: between 40 & 200 (Kp/cm2)

Fire Retardant certificates: UNE EN 1021-1:15 & UNE EN 1021-2:15, IMO – ANNEX 1 – PART 8 (MARITIME FIRE SAFETY STANDARDS), UNI 9175:2010, BS 5852:06.

## Table Tops Features

### DEKTON®

Ceramic surface with high resistance, suitable for indoor and outdoor use.

				Kelya	Entzo	Danae
				46	45	55
Flexural tensile strength or modulus of rapture	UNE EN ISO 10545-4	Average flexural resistance	N/mm2	46	45	55
		Average break load	N	2548	2313	2356
		Average break strength	N	14966	13559	13818
Water absorption, apparent porosity, density	UNE EN ISO 10545-3	Water absorption by boiling	%	0	0,1	0,1
		Water absorption by vacuum	%	0,1	0,1	0,1
		Open porosity	%	0,2	0,2	0,2
		Aparent relative density	g/cm3	2,51	2,61	2,53
		Aparent density	g/cm3	2,50	2,61	2,52
Resistance to deep abrasion	UNE EN ISO 10545-6	Wear volume	mm3	125	106	115
Impact resistance	UNE EN ISO 10545-5	Coefficient of restitution (COR)	-	0,85	0,85	0,85
Determination of linear thermal expansion	UNE EN ISO 10545-8	Expansion 30-100°C	°C-1	6,5 · 10-6	5,1 · 10-6	6,3 · 10-6
Thermal shock resistance	UNE EN ISO 10545-9	Damage	-	ULA (no damage)	ULA (no damage)	ULA (no damage)
Moisture expansion	UNE EN ISO 10545-10	Expansion max	mm/m	0,1	0,1	0,1
		Expansion mid	mm/m	0,0	0,0	0,0
Frost resistance	UNE EN ISO 10545-12	Damage	-	ULA (no damage)	ULA (no damage)	ULA (no damage)

### HPL / SOLID CORE

HPL Tabletops for Mari-sol, Faz and Delta table bases thickness is 10mm ± 0.55.

Thickness	ISO 4586 ½	mm	13 ± 0.55	
Density	ISO 1183	Kg/m3	1400 - 1500	
Absorción de agua	ISO 4586 ½	%	Weight	2.0 max.
			Thickness	2.0 max.
Estabilidad dimensional a altas temperaturas	ISO 4586 ½	%	Long.	0.25 max.
			Trans.	0.55 max.
Hardness	ASTM D 785	HR E	97 ca	
Resistencia a la flexión	ISO 178	MPa	Long.	145 min
			MPa	Trans

### GLASS

Security tempered glass. Thickness: 10 mm.

Technical Features	Units	Value
Resistant to soft body impact		2(B)2
Resistance against suddne temperature changes	K	40
Resistant to wind, snow and large weight	mm	10
Sound insulation	dB	34 (-1,-3)
Thermal Properties		
Thermal Transmittance (value U)	W/(m2K)	5.6
Light Transmission tV		0.53
Light Refletion pV		0.06/0.06
Solar Transmission tE		0.52
Solar Reflection pE		0.06/0.06

## Fabricts Features

Fabric	Weight Peso	Flame Resistance	Resistance	Color Fastness	Composition	Maintenance	Symbols
<b>Nautical.</b> Soft acrylic outdoor fabric with leather-like texture.	657 gr/m2	EN 1021 CAL TB 117 IMO MSC 307 NFPA 260 DIN 4102 B2 FMVSS 302 ONORM A 3800 TEIL 1	>100.000 cycles	XENOTEST DIN 54004/NTC 1479 ASTM D-4329/ CFFA-2 c2	Vinyl Coating, 100% Polyester Backing	Clean using a cotton cloth with neutral soap 1/9 water solution. Rub dry with a clean cloth and let dry.	
<b>Silvertex.</b> Soft-shiny acrylic outdoor fabric.	685 gr/m2	EN 1021 CAL TB 117 IMO MSC 307 DIN 4102 B2 NF P 92-503 / M2 UNE 23.727-90 IR/ M2 UNI 9175 NFPA 260	>300.000 cycles	>7 - DIN 54004 NTC 1479 (UV outdoor) 4 - ISO 105B04	Vinyl Coating, 100% Polyester Backing	Clean using a cotton cloth with neutral soap 1/9 water solution. Rub dry with a clean cloth and let dry.	
<b>Savane.</b> An irregular weave reveals its textural beauty. Suited naturally to all outdoor furnitures.	400 gr/m2	EN 1021 CAL TB 117 NFPA 260 BS 5852	50.000 cycles	(UV indoor) 8/8 - ISO 105B02 (UV outdoor) 4-5 - ISO 105B04	100% Acrylic	Clean using a cotton cloth with 1/5 household bleach solution. Remove all bleach residues with water. Rub dry with a clean cloth and let dry.	
<b>Dralon.</b> Basic acrylic outdoor fiber for contract products' cushions.	185 gr/m2	BS 5852 EN 1021 BS7176 Low hazard	25.000 cycles	(UV indoor) 6-7/8 - ISO 105B02 (water) 5 - ISO 105E03/02/01	100% Acrylic	Clean using a cotton cloth with neutral soap solution. Rub dry with a clean cloth and let dry.	
<b>Crevin.</b> Upholstery fabric with a medium size and elegant weave. 40% made with recycled PET.	520 gr/m2	EN 1021 BS 5852 CAL TB 117 NFPA 260	60.000 cycles	(water) 4-5 - ISO 105E03/02/01 (UV outdoor) >6 - ISO 105B04	40% Recycled PET 60% PP	Clean using a cotton cloth with 1/5 household bleach solution. Remove all bleach residues with water. Rub dry with a clean cloth and let dry.	
<b>Heritage.</b> Made using 50% of recycled plastics.	335 gr/m2	BS 5852 UNE 1021 CAL TB 117 NFPA 260	25.000 cycles	(UV indoor) 7-8/8 - ISO 105B02 (UV outdoor) 5/5 - ISO 105B04	50% Recycled acrylic, 47% Sunbrella acrylic, 3% PE	Clean using a cotton cloth with neutral soap solution. Rub dry with a clean cloth and let dry.	
<b>Velum.</b> Lightweight and semi-transparent fabrics for curtains. .	165 gr/m2	BS 5852 UNE 1021 CAL TB 117 NFPA 260	-	(UV indoor) 8/8 - ISO 105B02 (UV outdoor) 4-5 - ISO 105B04	100% Acrylic	Clean using a cotton cloth with 1/5 household bleach solution. Remove all bleach residues with water. Rub dry and let dry.	
<b>Batyline.</b> breathable acrylic mesh used on sun loungers and sunroofs.	500 gr/m2	EN 1021 1-2 EN 13501 - 1 DIN 4102 B1 NFP 92-507 CAL TB 117 IMO MSC 307 NFPA 260	>120.000 cycles	4/5 ASTM G154	Polyester fibre protected with PVC coating.	Wash the mesh with a mild liquid detergent and fresh water, using a soft bristle brush. Batyline mesh has anti-fungal treatment where the moist will have no effect on it.	
<b>Cico.</b> Cozy fabric with an elegant look and soft touch.	423 gr/m2	BS 5852 UNE 1021 CAL TB 117	25.000 cycles	(UV indoor) 7/8 - ISO 105B02 (UV outdoor) 4/5 - ISO 105B04	100% Polypropylene	Clean using a cotton cloth with neutral soap solution. Rub dry with a clean cloth and let dry.	
<b>Siesta.</b> Cozy fabric with an elegant look and soft touch.	500 gr/m2	UNE 1021 CAL TB 117	60.000 cycles	-	100% Polypropylene	Clean using a cotton cloth with neutral soap solution. Rub dry with a clean cloth and let dry.	
<b>Acapulco.</b> Cozy fabric with an elegant look and soft touch.	500 gr/m2	BS 5852 UNE 1021 CAL TB 117	>30.000 cycles	-	100% Polypropylene	Clean using a cotton cloth with neutral soap solution. Rub dry with a clean cloth and let dry.	
<b>Ikon 36.</b> Cozy fabric with an elegant look and soft touch.	650 gr/m2	BS 5852 CAL TB 117	30.000 cycles	-	100% Polypropylene	Clean using a cotton cloth with neutral soap solution. Rub dry with a clean cloth and let dry.	
<b>Kroilet.</b> Elegant fabric with a pleasant touch and great comfort.	985 gr/m2	BS 5852 CAL TB 117	40.000 cycles	-	94% PP + 6 % PC S.D.		
<b>Varm.</b> Cozy fabric with a pleasant touch and great comfort.	850 gr/m2	CAL TB 117 IMO MSC 307 BS 5852	60.000 cycles	Factor 7UV UNI EN ISO 20105-B02	100% Polypropylene		
<b>Hygge.</b> Cozy fabric with a pleasant touch and great comfort.	910 gr/m2	CAL TB 117 IMO MSC 307 BS 5852	60.000 cycles	Factor 7UV UNI EN ISO 20105-B02	100% Polypropylene	The whashing podwer should not contain oxidizing agents o brightening agents. In case of dropped liquid or water on the fbric remove all spills immediately but not the rub. Gently blot liquid spills with a clean dry cloth	
<b>Glad.</b> Premium fabric with a wide range of colours	975 gr/m2	CAL TB 117 IMO MSC 307 BS 5852	30.000 cycles	Factor 7UV UNI EN ISO 20105-B02	100% Polypropylene		

**DMX Wireless**

DMX 512 (Digital Multiplex) is a mechanism used for the electronic control of entertainment lighting, enabling communication between the control-table, our own lights and light sources. You can create customized and special environments. This allowed to control every Vondom product independently or in groups.

**There are 2 different DMX Wireless, depending on our customer needs:**

**DMX WIRELESS PROFESSIONAL XLR PACK**

Vondom DMX Wireless Professional XLR you can control all LED RGBW VONDOM pieces from your Mix Tables, PC+software, Domotic panels, etc.

1\* DMX Wireless Standard Configuration

Preset three separate Family products: POTS, LAMPS & FURNITURE.

2\* DMX Wireless Customized Configuration

You can send us your customized special environment that you want to control independently and we will set it up.

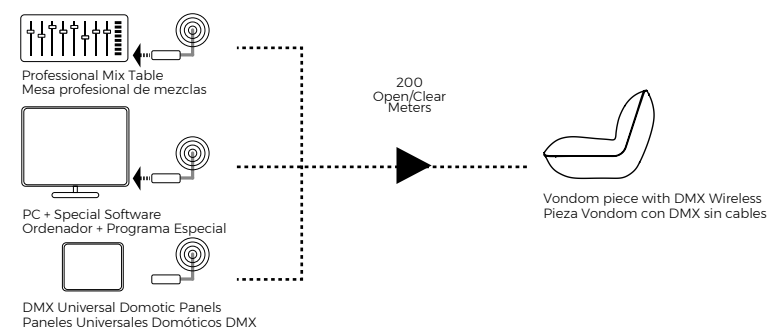

**2\* Example of DMX Wireless Professional Customized Configuration**

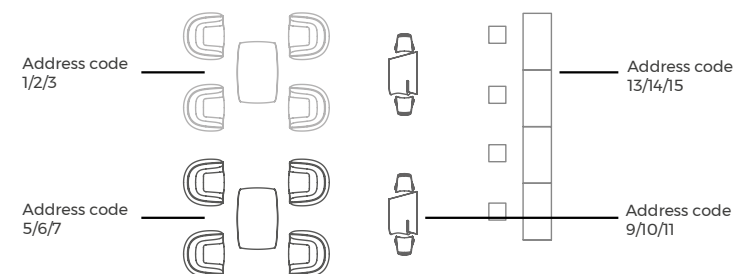

**DMX IS FUN!**

**DMX WIRELESS HOME WIFI PACK**

Vondom DMX Wireless Home Wi-Fi Pack is a WI-FI access point to control all LED RGBW VONDOM items with your IOS or Android devices.

1\* DMX Wireless Standard Configuration

Preset three separate Family products: PLANTERS, LAMPS & FURNITURE.

2\* DMX Wireless Customized Configuration

You can send us your customized requirements in order to control individually each item/group and we will set it up. (Max. 8 rooms).

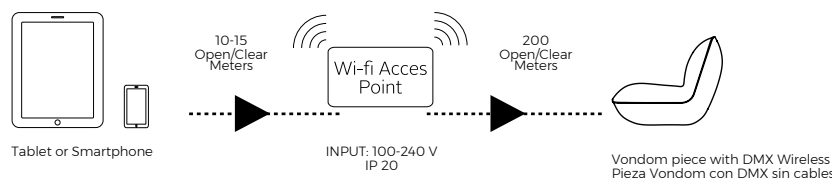

**2\* Example of DMX Wireless Home Customized Configuration**

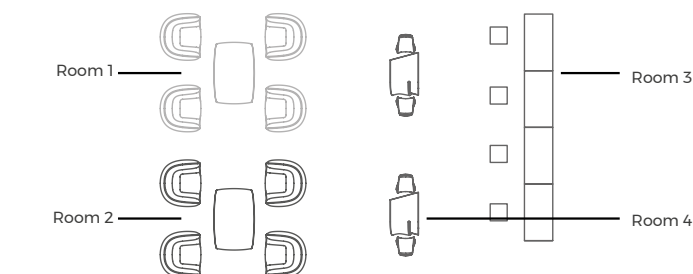

**MAINTENANCE & SAFETY GENERAL**

Our productions are manufactured according to ISO 9001:2008 quality and ISO 14001:2004 environmental quality, by using high quality materials we guarantee long life of our products.

In order to provide a durable and safe use to the product, please follow the following recommendations:

- Continuous exposure to the sun (especially with the dark colors) can cause burning injuries by direct contact with your skin. To avoid this, please check the temperature of the furniture in case of long-term exposure to the sun.
- Place the item on a flat surface to avoid uncontrolled movements.
- Keep the item far from excessive heat sources.
- The product is not a toy. To avoid accidents, do not to allow children to play with it.
- Keep furniture away dust to keep it clean, if cleaning is required we recommended the use of pressure washers, such as KARCHER'S and/or domestic degreasing cleaner periodically. Never use abrasive or corrosive products.
- To preserve the product, we recommend the usage of VONDOM cover for every item.
- In the case of lacquered products, we recommended car wax every 2 or 3 months, as it will avoid the appearance of possible scratches.
- Outdoor cushions are available only some models. We recommended you clean them periodically with a cloth and basic soap and water.
- Clean the stainless steel parts with appropriate products.
- When changing bulbs, please make sure the cord is not connected to the main power.
- If cords suffer any damage, they must be changed exclusively by the manufacturer or by a professional.
- If the RGBW LED stops working, please do not handle it. Contact the manufacturer or your distributor immediately.



**CLEANING GENERAL**

Vondom Outdoor Furniture cleans easily and stays impeccable.

Steps for clean outdoor furniture:

1. Spray the degreaser over the dirty surface.
  2. Rub it with a damp cloth.
  3. Rinse with abundant water with pressure washer.
- Cautions! Don't use pressure washer for cushions and lacquered finish items.
4. Dry it outside and enjoy our products.

We hope you enjoy our products. If you need any further information, please contact our CUSTOMER SERVICE department by calling **+34 96 239 84 86** or sending us an e-mail to **info@vondom.com**.

**Remote Control Instructions**

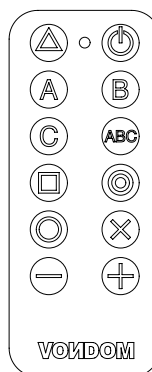

- △ Repeat last order (Re-send order)
- ⏻ ON / OFF
- A/B/C Groups ( A = Furniture and furnishings / B = Planters & Pots / C = Lamps ) can be customized, 3 maximum items.
- ABC Controls all groups simultaneously
- Automatic color change
- Memory Button (for programming custom colors) (consult "advanced functions")
- Programmed colors
- ⊗ Warm White 2700K / Natural White 4000k / Cool White 6500k
- +/- More / less (speed or intensity)

- Remote Control Battery: CR2032
- RF Controller: 433 Mhz / 10-15 meters (30-45 feet) range
- IP20 / indoor use only.

**KEY ICONS**

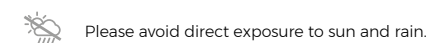

## ES | INFORMACIÓN TÉCNICA

### Acabados y Extras Mobiliario

#### SIMPLE

Acabado mate.

#### LACADO

Acabado lacado brillo.

#### BICOLOR LACADO

Acabado lacado brillo en dos colores diferentes. Para evitar posibles daños no se recomienda apilar el producto.

#### EXTRAS / OPCIONES

#### LED BLANCO

Mobiliario con iluminación de color blanco mediante tecnología LED. Solo disponible en acabado hielo mate.

#### RGBW LED

Mobilario con iluminación interior mediante tecnología LED RGBW y mando a distancia para cambiar de color. Solo disponible en acabado hielo mate.

#### RGBW LED DMX

Mobiliario con iluminación interior mediante tecnología LED RGBW y mando a distancia para cambiar de color. Controlado también por DMX-1024 (wireless), permitiendo la comunicación entre uno o multiples productos simultaneamente mediante el transmisor DMX (no incluido). Hay dos opciones para seleccionar. Professional XLR DMX y Home WIFI DMX.

1º DMX Wireless configuración estandar.

2º DMX Wireless configuración personalizable según el cliente.

#### CON BATERÍA

#### RGBW LED BATTERY

Mobiliario con iluminación interior mediante tecnología LED RGBW, alimentado por una batería. Se incluye mando a distancia para cambiar de color y cargador. Solo disponible en acabado hielo mate.

#### RGBW LED DMX BATTERY

Mobiliario con iluminación interior mediante tecnología LED RGBW, alimentado por una batería (incluye cargador y mando a distancia para cambio de color). Controlado por DMX-1024 (wireless), permitiendo la comunicación entre uno o multiples productos simultaneamente mediante el transmisor DMX (no incluido). Hay dos opciones para seleccionar. Professional XLR DMX y Home WIFI DMX.

Ambas opciones disponen de varias configuraciones:

1º DMX Wireless configuración estandar.

2º DMX Wireless configuración personalizable según el cliente.

### Acabados y Extras Maceteros y Jardineras

#### SIMPLE

Acabado mate.

#### SIMPLE LACADA

Acabado lacado brillo.

#### BASIC

Macetero acabado mate.

#### AUTORRIEGO

Macetero acabado mate con sistema de autorriego.

#### LACADO

Macetero acabado lacado brillo con sistema de autorriego.

#### EXTRAS / OPCIONES

#### LED BLANCO

Maceta con sistema de autorriego con iluminación interior de color blanco mediante tecnología LED. Solo disponible en acabado hielo mate.

#### RGBW LED

Maceta con sistema de autorriego, que incluye iluminación interior mediante tecnología LED RGBW y mando a distancia para cambiar de color. Solo disponible en acabado hielo mate.

#### RGBW LED DMX

Maceta con sistema de autorriego, que incluye iluminación interior mediante tecnología LED RGBW y mando a distancia para cambiar de color. Controlado por DMX-1024 (wireless), permitiendo la comunicación entre uno o multiples productos simultaneamente mediante el transmisor DMX (no incluido). Hay dos opciones para seleccionar. Professional XLR DMX y Home WIFI DMX. Ambas opciones disponen de varias configuraciones:

1º DMX Wireless configuración estandar.

2º DMX Wireless configuración personalizable según el cliente.

#### CON BATERÍA

#### RGBW LED BATTERY

Maceta con sistema autorriego, que incluye iluminación interior mediante tecnología LED RGBW, alimentado por una batería. Se incluye mando a distancia para cambiar de color y cargador. Solo disponible en acabado hielo mate.

#### RGBW LED DMX BATTERY

Maceta con sistema autorriego, que incluye iluminación interior mediante tecnología LED RGBW, alimentado por una batería (incluye cargador y mando a distancia para cambio de color). Controlado por DMX-1024 (wireless), permitiendo la comunicación entre uno o multiples productos simultaneamente mediante el transmisor DMX (no incluido). Hay dos opciones para seleccionar. Professional XLR DMX y Home WIFI DMX.

Ambas opciones disponen de varias configuraciones:

1º DMX Wireless configuración estandar.

2º DMX Wireless configuración personalizable según el cliente.

### Iluminación Información técnica

#### FUENTE DE ALIMENTACIÓN

#### LED BLANCO

- Color simple LEDs 4500 K

- 720 - 2800 LM Máx. (según modelos)

- 12 - 72 W Máx. (según modelos)

- Fuente de alimentación: Mean Well / Class 2 / IN: 100 - 240V AC / 50 - 60Hz

- IEE: Class A

- IP65 / aplicable para zonas húmedas

- Ta: 40°C

- 4-5 m. de cable Blanco Ho5RN-F 2G1 mm2 + Clavija (EU - AUS - UK) ☺ ☹ ☹

- 4-5 m. de cable Blanco SJTW - 2 x AWG18 + Clavija (USA) ⚡

- CE / RoHS / UL



#### NANO LED BLANCO

- Color simple LEDs 4500 K

- 40 LM

- 1,4 W Máx.

- Fuente de alimentación de pared: IN: 100-240V AC / 50-60Hz

- IEE: Clase A

- IP20 / Aplicable para interiores

- 2 m. de cable Transparente con interruptor de mano + Clavija EU ☺

- Ta: 35°C

- CE / RoHS

#### LED RGBW

- Multicolor LEDs RGBW

- Controlador RF433 Mhz / 10-15 metros de alcance

- 450 - 1100 LM Máx. (según modelos)

- 12 - 72 W Máx. (según modelos)

- Fuente de alimentación: Mean Well / Class 2 / IN: 100-240V AC / 50-60Hz

- IEE: Clase A

- IP65 / Aplicable para zonas húmedas

- Ta: 40°C

- 4-5 m. de cable Blanco Ho5RN-F 2G1 mm2 + Clavija (EU - AUS - UK) ☺ ☹ ☹

- 4-5 m. de cable Blanco SJTW - 2 x AWG18 + Clavija (USA) ⚡

- CE / RoHS / UL



#### LED RGBW DMX

- Multicolor LEDs RGBW

- Controlador RF433 Mhz / 10-15 metros de alcance

- Decodificador DMX 1024 / Señal sin cables 2,4 Ghz

-Controlador Home WiFi DMX Sin Cables, compatible con IOS y Android (no incluido)

-Controlador Profesional DMX Sin Cables, conector XLR (no incluido)

- 450 - 1100 LM Máx. (según modelos)

- 12 - 72 W Máx. (según modelos)

- Fuente de alimentación: Mean Well / Class 2 / IN: 100-240V AC / 50-60Hz

- IEE: Clase A

- IP65 / Aplicable para zonas húmedas

- Ta: 40°C

- 4-5 m. de cable Blanco Ho5RN-F 2G1 mm2 + Clavija (EU - AUS - UK) ☺ ☹ ☹

- 4-5 m. de cable Blanco SJTW - 2 x AWG18 + Clavija (USA) ⚡

- CE / RoHS / UL



#### CON BATERÍA

#### LED RGBW BATERIA

- Multicolor LEDs RGBW

- Controlador RF433 Mhz / 10-15 metros de alcance

- 450 - 1100 LM Máx. (según modelos)

- 12 - 72 W Máx (según modelos)

- Batería Li-ion 5.2 - 19 Ah (según modelos) 12V / 6-8 h autonomía / Carga 5h - 500 ciclos /

- Cargador 1,5A - 4A (segun modelos) IN: 100-240V AC / 50-60Hz

- CE / RoHS / IP65 (Aplicable para zonas húmedas)

- Ta: 40°C

#### LED RGBW DMX + BATERIA

- Multicolor LEDs RGBW

- Controlador RF433 Mhz / 10-15 metros de alcance

- Decodificador DMX 1024 / Señal sin cables 2,4 Ghz

-Controlador Home WiFi DMX Sin Cables, compatible con IOS y Android (no incluido)

-Controlador Profesional DMX Sin Cables, conector XLR (no incluido)

- 450 - 1100 LM Máx. (según modelos)

- 12 - 72 W Máx (según modelos)

- Batería Li-ion 5.2 - 19 Ah (según modelos) 12V / 6-8 h autonomía / Carga 5h - 500 ciclos /

- Cargador 1,5A - 4A (segun modelos) IN: 100-240V AC / 50-60Hz

- CE / RoHS / IP65 (Aplicable para zonas húmedas)

- Ta: 40°C

#### NANO LED RGBW BATERIA

- Multicolor LEDs RGBW

- Controlador RF433 Mhz / 10-15 metros de alcance

- 40 - 100 LM Máx - 1,5 W Máx

- Batería Li-ion 2 Ah / 5V / 6-8 h autonomía / Carga 5h /

- Cargador 0,5A IN: 100-240V AC / 50-60Hz

- CE / RoHS / IP65 (Aplicable para zonas húmedas)

- Ta: 40°C

#### LED BLANCO LÁMPARAS DE MESA

- LED Blanco cálido 2700kº

- ON/OFF y Control de intensidad táctil

- 0.8W (Con batería) - 3.3 W Max. (Conectado a la corriente).

- Batería Li-ion 3000 mA 4.2V / 12 h autonomía / Carga 4h - 500 ciclos

- Cargador USB 5v DC 1A / IN: 100-240V AC / 50-60Hz

- Ta: 40°C

- IEE: Clase A++ / IP54 / CE

#### RGBW LED LÁMPARAS DE MESA

- 5 LEDs Colors. (Azul / Fucsia / Ámbar / Turquesa / Blanco cálido 2700kº)

- ON/OFF y Control de intensidad táctil

- 0.8W (Con batería) - 3.3 W Max. (Conectado a la corriente).

- Batería Li-ion 3000 mA 4.2V / 12 h autonomía / Carga 4h - 500 ciclos

- Cargador USB 5v DC 1A / IN: 100-240V AC / 50-60Hz

- Ta: 40°C

- IEE: Clase A+ / IP54 / CE

#### RGBW LED DMX LÁMPARAS DE MESA

- 5 LEDs Colors. (Azul / Fucsia / Ámbar / Turquesa / Blanco cálido 2700kº)

- ON/OFF y Control de intensidad táctil

- Decodificador DMX 1024 / Señal sin cables 2,4 Ghz

-Controlador Home WiFi DMX Sin Cables, compatible con IOS y Android (no incluido)

-Controlador Profesional DMX Sin Cables, conector XLR (no incluido)

- 0.8W (Con batería) - 3.3 W Max. (Conectado a la corriente).

- Batería Li-ion 3000 mA 4.2V / 12 h autonomía / Carga 4h - 500 ciclos

- Cargador USB 5v DC 1A / IN: 100-240V AC / 50-60Hz

- Ta: 40°C

- IEE: Clase A+ / IP54 / CE





# ES | INFORMACIÓN TÉCNICA

## Materiales Características

### POLIPROPILENO

- Material: Resina de polipropileno con fibra de vidrio, Estabilizador UV.
- Proceso: moldeo por inyección.
- Resistente a los golpes.
- Ligero .
- 100% reciclable.

### POLIETILENO

- Material: Resina de . Polietileno lineal de baja densidad. UL94 HB.
- Proceso: Moldeo rotacional.
- Resistente a UVI. Factor UV8, equivalente a 8.000 horas de sol de Florida.
- Resistente a temperaturas extremas (-60°C a +80°C) / ( -76°F to 176°F)
- Resistente a impactos.
- Ligera.
- Reciclable 100%.

### POLICARBONATO

- Material: Resina de policarbonato. Alta resistencia a la rotura.
- Proceso: moldeo por inyección.
- Resistente a los golpes.
- Ligero .
- 100% reciclable.

### ALUMINIO (PIES DE MESA)

- Material: AISI12 (EN ACE-44100)
- Proceso: Fundición de aluminio.
- Resistente a los golpes.
- 100% reciclable.
- Pintado al horno con pintura epoxy.

### ALUMINIO (PERFILERÍA)

- Material: 6060 (AlMgSi,3.3206,A96060).
- Proceso: Extrusión de aluminio.
- Resistente a los golpes.
- 100% reciclable.
- Pintado al horno con pintura epoxy.

### MADERA DE TECA

- La teca indonesia premium es duradera y excepcionalmente resistente a los elementos
- La teca natural se desgasta hasta adquirir una pátina gris plateada suave con el tiempo debido a los efectos del sol y la humedad
- **Por favor consulte en la web el mantenimiento y cuidados de la teca**

### MADERA DE TECA ENVEJECIDA

- La teca indonesia premium es duradera y excepcionalmente resistente a los elementos
- El acabado con cepillo de alambre aplicado a mano de la teca envejecida ofrece un aspecto ya desgastado.

- **Por favor, consulte en la web el mantenimiento y cuidados de la teca**

### RELLENO DE LOS COJINES PARA SILLAS

Espuma de poliuretano ideal para usos exteriores y en zonas con mucha humedad.

Características Técnicas	Unidad	Valor	Tolerancia
Composición	-	100% Poliéster	-
Tipo de fibra	-	Solida, semi-dull	-
Tª máxima de utilización	°C	110.0	±1.0
Proceso de Fabricación	Cardado por vía seca y consolidado térmico.		
Reciclabilidad	100%, en cuanto a que no contiene aditivos ni ligantes.		

Otras Propiedades:

- No absorbe ni retiene humedad, no es putrescible.
- No constituye alimento para insectos ni roedores.
- No desprende partículas durante su manipulación. Es un producto inocuo, no irrita mucosas ni la piel.

### ESPUMA DE POLIURETANO (PRODUCTOS TAPIZADOS)

Mobiliario fabricado en poliuretano flexible inyectado en frío. Este material posee una alta resiliencia y durabilidad. La espuma flexible de poliuretano posee una estructura celular abierta, es un material muy elástico, que cuando se retira la carga a la que haya sido sometida, recupera instantáneamente su forma original. Dificulta el crecimiento de hongos y bacterias.

- Resistencia a la tracción entre 3 y 10 (Kp/cm2)
- Resistencia a la compresión entre 1,5 y 9 (Kp/cm2)
- Resistencia al cizallamiento entre 1 y 5 (Kp/cm2)
- Módulo de elasticidad entre 40 y 200 (Kp/cm2)

Certificados Ignífugos: UNE EN 1021-1:15 & UNE EN 1021-2:15, IMO - ANNEX 1 – PART 8 (MARITIME FIRE SAFETY STANDARDS), UNI 9175:2010, BS 5852:06.

## Sobres de mesa Características

### DEKTON ®

Superficies cerámicas de alta resistencia, apto para uso interior y exterior.

				Kelya	Entzo	Danae
Resistencia a la flexión y carga de rotura.	UNE EN ISO 10545-4	Resistencia flexión media	N/mm2	46	45	55
		Carga de rotura media	N	2548	2313	2356
		Fuerza de rotura media	N	14966	13559	13818
Absorción de agua, porosidad abierta y densidades.	UNE EN ISO 10545-3	Absorción de agua por ebullición	%	0	0,1	0,1
		Absorción de agua por vacío	%	0,1	0,1	0,1
		Porosidad abierta	%	0,2	0,2	0,2
		Densidad relativa aparente	g/cm3	2,51	2,61	2,53
		Densidad aparente	g/cm3	2,50	2,61	2,52
Abrasión profunda.	UNE EN ISO 10545-6	Volumen abrasionado	mm3	125	106	115
Resistencia al impacto.	UNE EN ISO 10545-5	Coefficiente de restitución medio	-	0,85	0,85	0,85
Dilatación térmica lineal.	UNE EN ISO 10545-8	Dilatación entre 30-100°C	°C <sup>-1</sup>	6,5 · 10 <sup>-6</sup>	5,1 · 10 <sup>-6</sup>	6,3 · 10 <sup>-6</sup>
Resistencia a choque térmico.	UNE EN ISO 10545-9	Daño	-	Pasa sin daño	Pasa sin daño	Pasa sin daño
Dilatación por humedad.	UNE EN ISO 10545-10	Expansión máxima	mm/m	0,1	0,1	0,1
		Expansión media	mm/m	0,0	0,0	0,0
Resistencia a la helada.	UNE EN ISO 10545-12	Daño	-	Pasa sin daño	Pasa sin daño	Pasa sin daño

### HPL / SOLID CORE

Tableros prensado a alta presión y alta temperatura.

Grosor	ISO 4586 ½	mm	13 ± 0,55		
Densidad	ISO 1183	Kg/m3	1400 - 1500		
Absorción de agua	ISO 4586 ½	%	Peso	2,0 max.	
			Espesor	2,0 max.	
Estabilidad dimensional a altas temperaturas	ISO 4586 ½	%	Long.	0,25 max.	
			Trans.	0,55 max.	
Dureza	ASTM D 785	HR E	97 ca		
Resistencia a la flexión	ISO 178	MPa	Long.	145 min	
			Trans	135 min	

### VIDRIO

Cristal templado de seguridad. Grosor: 10 mm.

Resistencia al impacto de cuerpo blando		2(B)2
Resistencia contra cambios repentinos de temperatura y diferenciales de temperatura	K	40
Resistencia al viento, nieve, carga permanente e impuesta	mm	10
Atenuación acústica al ruido aéreo directo	dB	34 (-1,-3)
Transmisión térmica (valor U)	W/(m2,K)	5.6
Transmisión luminosa tv		0.53
Reflexión luminosa pV		0.06/0.06
Transmisión energía solar tE		0.52
Reflexión energía solar pE		0.06/0.06

## Fabrics Features

FABRIC TEJIDO	WEIGHT PESO	FLAME RESISTANCE RESIST. IGNIFUGA	RESISTANCE ABRASION	COLOR FASTNESS SOLIDEZ DEL COLOR	COMPOSITION COMPOSICIÓN	MAINTENANCE MANTENIMIENTO	SYMBOLS SÍMBOLOS
<b>Nautical.</b> Suave tela acrílica para exteriores con textura similar al cuero..	657 gr/m2	EN 1021 CAL TB 117 IMO MSC 307 NFPA 260 DIN 4102 B2 FMVSS 302 ÖNORM A 3800 TEIL 1	>100.000 ciclos	XENOTEST DIN 54004/NTC 1479 ASTM D-4329/ CFFA-2 c2	revestimiento de vinilo, 100% Poliester Backing	Limpiar usando un trapo de algodón con jabon neutro diluido en 1/9 partes de agua. Seque con un paño limpio y deje secar.	
<b>Silvertex.</b> Tela de exterior acrílica suave y brillante.	685 gr/m2	EN 1021 CAL TB 117 IMO MSC 307 DIN 4102 B2 NF P 92-503 / M2 UNE 23.727-90 IR/ M2 UNI 9175 NFPA 260	>300.000 ciclos	>7 - DIN 54004 NTC 1479  (UV outdoor) 4 - ISO 105B04	revestimiento de vinilo, 100% Poliester Backing	Limpiar con un paño de algodón con solución de jabón neutro 1/9 de agua. Secar con un paño limpio y dejar secar	
<b>Savane.</b> Un tejido irregular revela su belleza textural. Se adapta naturalmente a todos los muebles de exterior.	400 gr/m2	EN 1021 CAL TB 117 NFPA 260 BS 5852	50.000 ciclos	(UV indoor) 8/8 - ISO 105B02  (UV outdoor) 4-5 - ISO 105B04	100% Acrilico	Limpiar con un paño de algodón con 1/5 de solución de lejía doméstica. Retire todos los residuos de lejía con agua. Seque con un paño limpio y deje secar.	
<b>Dralon.</b> Fibra acrílica básica para exterior para cojines de productos contract.	185 gr/m2	BS 5852 EN 1021 BS7176 Low hazard	25.000 ciclos	(UV indoor) 6-7/8 - ISO 105B02  (water) 5 - ISO 105E03/02/01	100% Acrilico	Limpiar con un paño de algodón con solución jabonosa neutra. Seque con un paño limpio y deje secar.	
<b>Crevin.</b> Tela de tapicería de tamaño medio y trama elegante. 40% fabricado con PET reciclado.	520 gr/m2	EN 1021 BS 5852 CAL TB 117 NFPA 260	60.000 ciclos	(water) 4-5 - ISO 105E03/02/01 (UV outdoor) >6 - ISO 105B04	40% Reciclado PET 60% PP	Limpiar con un paño de algodón con 1/5 de solución de lejía doméstica. Retire todos los residuos de lejía con agua. Seque con un paño limpio y deje secar.	
<b>Heritage.</b> Fabricado con un 50% de plásticos reciclados.	335 gr/m2	BS 5852 UNE 1021 CAL TB 117 NFPA 260	25.000 ciclos	(UV indoor) 7-8/8 - ISO 105B02  (UV outdoor) 5/5 - ISO 105B04	50 <span> </span> % acrílico reciclado, 47 <span> </span> % acrílico Sunbrella, 3 <span> </span> % PE	Limpiar con un paño de algodón con solución jabonosa neutra. Seque con un paño limpio y deje secar.	
<b>Velum.</b> Tejidos ligeros y semitransparentes para cortinas..	165 gr/m2	BS 5852 UNE 1021 CAL TB 117 NFPA 260	-	(UV indoor) 8/8 - ISO 105B02 (UV outdoor) 4-5 - ISO 105B04	100% Acrilico	Limpiar con un paño de algodón con 1/5 de solución de lejía doméstica. Retire todos los residuos de lejía con agua. Frote y deje secar.	
<b>Batylne.</b> Malla acrílica transpirable utilizada en tumbonas y techos solares.	500 gr/m2	EN 1021 1-2 EN 13501 - 1 DIN 4102 B1 NFP 92-507 CAL TB 117 IMO MSC 307 NFPA 260	>120.000 ciclos	4/5 ASTM G154	Fibra de poliéster protegida con revestimiento de PVC.	Lave la malla con un detergente líquido suave y agua dulce, utilizando un cepillo de cerdas suaves. La malla Batylne tiene tratamiento anti hongos donde la humedad no le afectará.	
<b>Cico.</b> Tejido acogedor de aspecto elegante y tacto suave.	423 gr/m2	BS 5852 UNE 1021 CAL TB 117	25.000 ciclos	(UV indoor) 7/8 - ISO 105B02  (UV outdoor) 4/5 - ISO 105B04	100% polipropileno	Limpiar con un paño de algodón con solución jabonosa neutra. Seque con un paño limpio y deje secar.	
<b>Siesta.</b> Tejido acogedor de aspecto elegante y tacto suave.	500 gr/m2	UNE 1021 CAL TB 117	60.000 ciclos	-	100% polipropileno	Limpiar con un paño de algodón con solución jabonosa neutra. Seque con un paño limpio y deje secar.	
<b>Acapulco.</b> Tejido acogedor de aspecto elegante y tacto suave.	500 gr/m2	BS 5852 UNE 1021 CAL TB 117	>30.000 ciclos	-	100% polipropileno	Limpiar con un paño de algodón con solución jabonosa neutra. Seque con un paño limpio y deje secar.	
<b>Ikon 36.</b> Tejido acogedor de aspecto elegante y tacto suave	650 gr/m2	BS 5852 CAL TB 117	30.000 ciclos	-	100% polipropileno	Limpiar con un paño de algodón con solución jabonosa neutra. Seque con un paño limpio y deje secar.	
<b>Krollet.</b> Elegant fabric with a pleasant touch and great comfort.	985 gr/ml	BS 5852 CAL TB 117	40.000 cycles	-	94% PP + 6 <span> </span> % PC S.D.		
<b>Varm.</b> Tejido acogedor de tacto agradable y gran comodidad.	850 gr/m2	CAL TB 117 IMO MSC 307 BS 5852	60.000 cycles	Factor 7UV UNI EN ISO 20105-B02	100% polipropileno	El detergente en polvo no debe contener agentes oxidantes ni abrillantadores. En caso de que caiga líquido o agua sobre la tela, elimine todos los derrames inmediatamente, pero no frote el tejido. Seque suavemente los derrames de líquidos con un paño limpio y seco.	
<b>Hygge.</b> Tejido acogedor de tacto agradable y gran comodidad.	910 gr/m2	CAL TB 117 IMO MSC 307 BS 5852	60.000 cycles	Factor 7UV UNI EN ISO 20105-B02	100% polipropileno		
<b>Glad.</b> Tejido premium con una amplia gama de colores.	975 gr/m2	CAL TB 117 IMO MSC 307 BS 5852	30.000 cycles	Factor 7UV UNI EN ISO 20105-B02	100% polipropileno		

**DMX Sin cables**

DMX 512 (Digital MultipleX), es un protocolo electrónico utilizado en luminotecnia para el control de la iluminación de espectáculos, permitiendo la comunicación entre los equipos de control de luces y las propias fuentes de luz.

DMX Sin Cables. Puedes crear ambientes especiales y personalizados. Permite controlar cada producto Vondom de manera independiente o en grupos.

Hay 2 tipos de DMX Wireless, dependiendo las necesidades del cliente.

**DMX WIRELESS PROFESSIONAL XLR PACK**

Con Vondom DMX Profesional XLR Sin cables se puede controlar todos los productos VONDOM mediante una mesa de mezclas, Ordenadores + Programa, Paneles Domoticos, etc.

1\* DMX Wireless Configuración Estándar

Están preconfiguradas tres Familias independientes: MACETAS, LAMPARAS, MOBILIARIO.

2\* DMX Wireless Configuración Personalizada

Puede indicarnos los productos o grupos que necesita controlar independientemente y nosotros lo configuraremos.

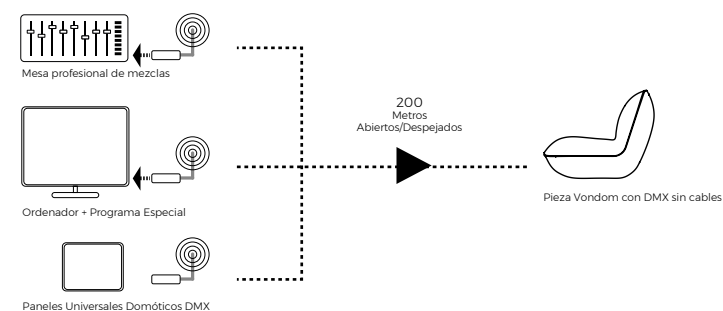

**2\* Ejemplo de configuración personalizada DMX Wireless Professional**

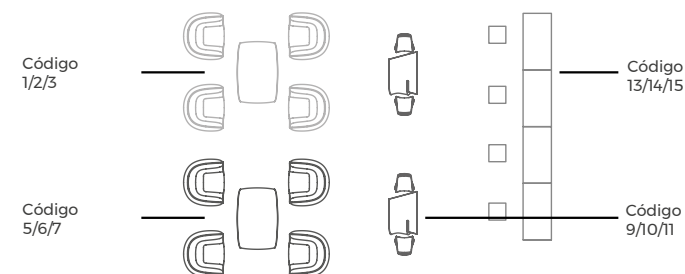

**DMX IS FUN!**

**DMX WIRELESS HOME WIFI PACK**

El paquete Home Wi-Fi Vondom DMX Sin cables es un punto de acceso Wi-Fi con el que controlar todos sus productos VONDOM mediante sus dispositivos IOS o Android.

1\* DMX Wireless Configuración Estándar

Están preconfiguradas tres Familias independientes: MACETAS, LAMPARAS, MOBILIARIO.

2\* DMX Wireless Configuración Personalizada

Puede indicarnos los productos o grupos que necesita controlar independientemente y nosotros lo configuraremos. (Máx. 8 zonas)

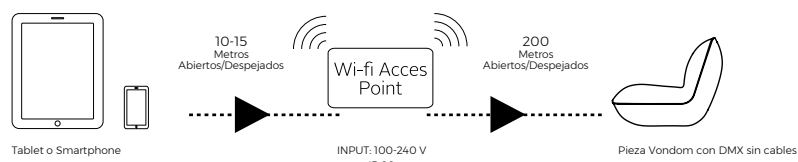

**2\* Ejemplo de configuración personalizada DMX Wireless Home**

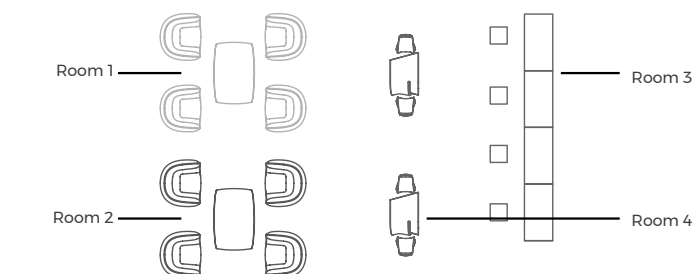

**Control Remoto Instrucciones**

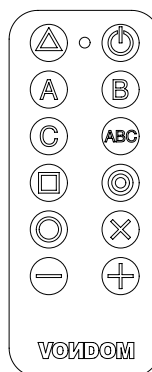

- △ Repetir la última orden (Enviar la orden de nuevo)
- ⏻ on / off
- A/B/C Grupos (A = Mobiliario / B = Macetas / C = Lámparas) Se pueden personalizar, máximo 3.
- ABC Controlar todas los grupos a la vez
- Cambio de color automático
- Botón Memoria (para programar un color personalizado) (consultar las funciones avanzadas)
- Colores programados
- × Blanco cálido 2700K / Blanco natural 4000k / Blanco frío 6500k
- +/- Mas o menos (velocidad o intensidad)

- Pilas para el Control Remoto: CR2032
- Controlador RF 433 Mhz / 10-15 metros de alcance.
- IP20 / Apto solo para uso interior.

**MANTENIMIENTO Y SEGURIDAD GENERAL**

Nuestra producción se rige según las normas de nuestro sistema de aseguramiento de la calidad ISO 9001:2008 y de medio ambiente ISO 14001:2004. Y solamente utilizamos materiales de altísima calidad para garantizar una larga vida útil a los productos.

Para proporcionarle un uso duradero y seguro al producto, por favor siga las siguientes instrucciones:

- La exposición continua al Sol, especialmente los colores oscuros, puede provocar lesiones por contacto con la piel. Tenga la precaución de verificar la temperatura de los muebles antes de su uso en horas de sol extremo.
- Coloque la pieza en una superficie regular y sin pendiente para evitar desplazamientos incontrolados.
- Manténgala alejada de fuentes de calor excesivas.
- El producto no es un juguete. No permita que los niños jueguen con ellos, para evitar accidentes.
- Mantenga sus muebles fuera de fuentes de polvo para mantenerlos limpios. En caso de que se requiera su limpieza se recomienda el uso de sistemas de presión de agua tipo KARCHER y/o desengrasantes domésticos de forma periódica. Nunca utilice productos abrasivos o corrosivos.
- Para una mejor conservación del mobiliario, se aconseja cubrir con fundas para cada uno de los artículos.
- En los productos lacados hay que extremar su cuidado puesto que son más delicadas, no debe utilizar agua a presión ni productos abrasivos o corrosivos. Para ello, es aconsejable aplicar cada 2 ó 3 meses cera de carrocería y así eliminar la aparición de posibles arañazos.
- Existen acolchados aptos para el exterior, disponibles para algunas colecciones. Se recomienda limpiarlos periódicamente utilizando un paño con jabón neutro y agua.
- Limpie las partes de acero inoxidable con productos adecuados.
- En caso de sustituir la bombilla, asegúrese de que el cable no está conectado a la corriente eléctrica.
- Si el cable sufre algún deterioro, debe cambiarse exclusivamente por el fabricante o por un profesional.
- Si el LED dejara de funcionar, no manipular en ningún caso y contactar con el fabricante o distribuidor del producto.

**LIMPIEZA GENERAL**

Vondom Mobiliario de exterior se limpia fácilmente y permanece impecable.

Pasos para limpiar mobiliario the exterior:

1. Pulverice con un quitagrasas la superficie a limpiar.
2. Frote con un paño húmedo y agua.
3. Aclare con abundante agua con un sistema de agua a presión.
- ¡Atención! No use el sistema de agua a presión para acolchados y acabados lacados.
4. Déjalo secar en el exterior.

- Esperemos que disfrute de nuestros productos. Si desea más información no dude en comunicárselo a nuestro departamento de ATENCIÓN AL CLIENTE llamando al **+34 96 239 84 86** o enviando un correo electrónico a [info@vondom.com](mailto:info@vondom.com)

**LEYENDAS**

- Evitar la exposición directa al sol y la lluvia.



**ES |** Las posibles diferencias entre el color original y el color reproducido se deben a la técnica de impresión.

VONDOM se reserva el derecho exclusivo sobre todas las marcas, fotografías y diseños utilizados en sus colecciones, por lo que queda prohibida la fabricación, distribución y/o comercialización de los productos que los contienen, en cualquier medio o soporte.

En particular quedan reservados a favor de su titular los derechos de reproducción total o parcial, la transformación de los mismos y/o su utilización fuera de la esfera privada y con fines comerciales.

VONDOM se reserva el derecho de modificar total o parcialmente sin aviso previo cualquiera de los datos y especificaciones de esta publicación.

Toda la información que aparece en este catálogo referente a dimensiones y capacidades son aproximadas.

© Copyright. 2023. Vondom, S.L.U.

Todos los Derechos a beneficio de VONDOM

**EN |** The possible differences between pictures and real items could be due to the colors in the printing technology process.

VONDOM all rights related to trademarks, pictures and designs are reserved.

All manufacturing distribution and/or trading activities in any media of the products displayed in the collections are prohibited. Specifically those rights about total or partial reproduction, transformation and/or usage in public with commercial purposes.

VONDOM reserves the right to effect any changes or improvements, without notice.

All the information included in this catalogue regarding sizes and capacities are approximated.

© Copyright. 2023. Vondom, S.L.U.

All rights reserved to the order of VONDOM

# VONDOM

vondom.com

## HEAD QUARTERS - FACTORY

VONDOM S.L.U.  
Poligono 6, 16  
46293 - Beneixida, Valencia - Spain  
t.: +34 96 239 84 86 • info@vondom.com

## Latinoamérica

Av. Pdte. Masaryk 42, Rincón del Bosque,  
Polanco V Secc, Miguel Hidalgo  
11580 Ciudad de México, México  
t.: +52 55 11 13 99 73 • +52 55 11 13 99 74  
latam@vondom.com

## USA

VONDOM LLC.  
8803 NW 23rd Street, Miami, FL 33172 - USA  
ph.: +1 786 391 0274 • +1 786 353 9108  
infousa@vondom.com

## China

VONDOM Lifestyle Design Co., Ltd.  
C6-103, No. 700, Wan Rong Road, Jing An  
200072 - Shanghai - China • +86 21 6521 9916  
infochina@vondom.com

**VONDOM**