



VINCENT  
SHEPPARD

outdoor  
collection  
2024

# INDEX

## COLLECTIONS

ANTON	11	MAX	108
BISTRO TABLES	108	MAYA	92
CLEO	46	MIA	153
CLIFF	74	MONA	54
DAVID	76	MORA	92
EDGARD	120	NOA	54
FREYA	54	ODA	12
FRIDA	4	OLAF	109
GIPSY	120	OTTO	169
IVO	132   154	REMI	54
KENZO	153	ROXANNE	109
KODO	20	ROXY	109
LENA	120	ROY	102
LENTO	38	ROZY	111
LEO	64	SAFI	144
LIGHT MY TABLE	92	SAM	11
LILO	53	TIKA	92
LOOP	84	TOUNDRA	74
LLOYD LOOM	156	VOLTA	54
LUCY	134	WICKED	112
MATTEO	130		

DECO CUSHIONS	168
---------------	-----

TECHNICAL INFORMATION	171
-----------------------	-----

FABRICS	174
---------	-----

PRODUCT OVERVIEW	177
------------------	-----

## Finding comfort

Vincent Sheppard has been designing and manufacturing indoor and outdoor furniture with exceptional seating comfort since 1992. The company is worldwide market leader in Lloyd Loom furniture, a technique where kraft paper is twisted around a metal wire and woven into unique furniture pieces.

By constantly challenging itself and its design aesthetics, Vincent Sheppard is able to present young, contemporary furniture collections that answer to all modern needs. We combine a clear focus on quality and comfort with craftsmanship and an age-old technique, and translate these ingredients into qualitative, durable and appealing designs. With a wide variety of indoor as well as outdoor pieces of high quality, Vincent Sheppard is a favourite of many interior aficionados.

**The Vincent Sheppard team**

# FRIDA

A distinctive design with a spacious back, round frame and tactile seat.  
Beautiful from all sides and angles.



LOUNGE CHAIR - DINING CHAIR





FRIDA LOUNGE CHAIR anthracite  
ANTON COFFEE TABLE





FRIDA DINING CHAIR anthracite



FRIDA DINING CHAIR anthracite  
SAM DINING TABLE





FRIDA DINING CHAIR dune white  
NOA DINING TABLE



### FRIDA LOUNGE CHAIR

#### MATERIALS

untreated teak or black stained brushed teak  
polypropylene rope

#### COLOUR



UNTREATED TEAK  
ANTHRACITE ROPE



UNTREATED TEAK  
DUNE WHITE ROPE



BRUSHED TEAK BLACK  
ONYX BLACK ROPE

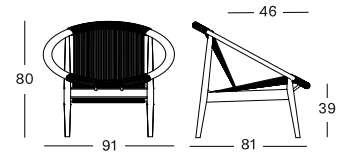

### FRIDA DINING CHAIR

#### MATERIALS

untreated teak  
polypropylene rope

#### COLOUR



UNTREATED TEAK  
ANTHRACITE ROPE



UNTREATED TEAK  
DUNE WHITE ROPE

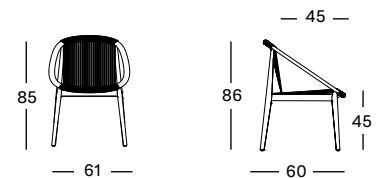

### ANTON SIDE & COFFEE TABLE TEAK

#### MATERIALS

untreated teak

#### DIMENSIONS

- 40,5 cm H x Ø 40 cm
- 34,5 cm H x Ø 70 cm

#### COLOUR



UNTREATED TEAK

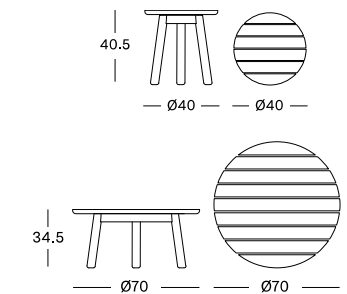

### SAM DINING TABLE

#### MATERIALS

untreated solid teak

#### DIMENSIONS

75 cm H x Ø 120 cm

#### COLOUR



UNTREATED TEAK

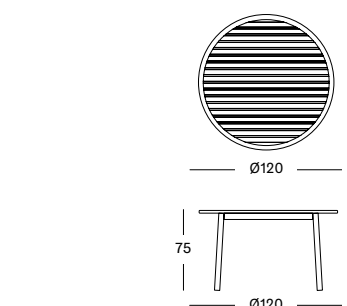



# ODA

Warm teak, textured straps and pillow-like cushions create an ambiance that is both playful and inviting.



LOUNGE CHAIR - LOUNGE SOFA 2,5S - LOUNGE SOFA 3S - SIDE TABLE - COFFEE TABLE









LEFT PAGE: ODA COFFEE TABLES ceramic portland  
RIGHT PAGE: ODA LOUNGE CHAIR







### ODA LOUNGE CHAIR

#### MATERIALS

untreated teak  
polypropylene straps

#### CUSHION

seat 14 cm quick dry foam  
back polyester fibre filling

#### COLOURS



UNTREATED TEAK  
FLAX STRAP

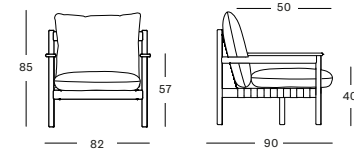

### ODA LOUNGE SOFA 2,5S

#### MATERIALS

untreated teak  
polypropylene straps

#### CUSHIONS

seat 14 cm quick dry foam  
back polyester fibre filling

#### COLOURS



UNTREATED TEAK  
FLAX STRAP

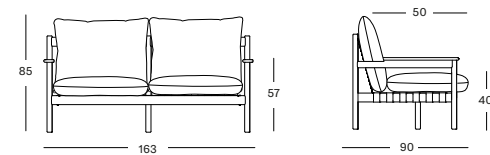

### ODA LOUNGE SOFA 3S

#### MATERIALS

untreated teak  
polypropylene straps

#### CUSHIONS

seat 14 cm quick dry foam  
back polyester fibre filling

#### COLOURS



UNTREATED TEAK  
FLAX STRAP

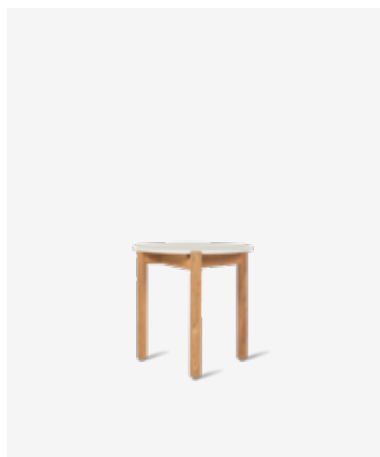
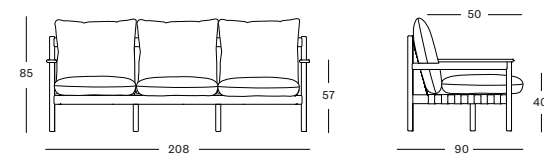

### ODA SIDE TABLE DIA 45

#### MATERIALS

untreated teak  
ceramic

#### DIMENSIONS

45 cm H x Ø 45 cm

#### COLOURS



UNTREATED TEAK  
FLINT CERAMIC



UNTREATED TEAK  
SHARDS CERAMIC



UNTREATED TEAK  
PORTLAND CERAMIC

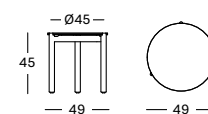

### ODA COFFEE TABLE DIA 68

#### MATERIALS

untreated teak  
ceramic

#### DIMENSIONS

35 cm H x Ø 68 cm

#### COLOURS



UNTREATED TEAK  
FLINT CERAMIC



UNTREATED TEAK  
SHARDS CERAMIC



UNTREATED TEAK  
PORTLAND CERAMIC

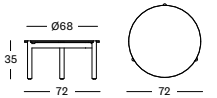

### ODA COFFEE TABLE DIA 90

#### MATERIALS

untreated teak  
ceramic

#### DIMENSIONS

30 cm H x Ø 90 cm

#### COLOURS



UNTREATED TEAK  
FLINT CERAMIC



UNTREATED TEAK  
SHARDS CERAMIC



UNTREATED TEAK  
PORTLAND CERAMIC

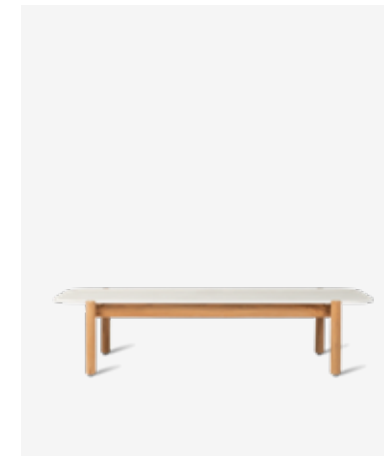
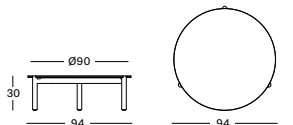

### ODA COFFEE TABLE 129X53

#### MATERIALS

untreated teak  
ceramic

#### DIMENSIONS

30 cm H x 53 cm x 129 cm

#### COLOURS



UNTREATED TEAK  
FLINT CERAMIC



UNTREATED TEAK  
SHARDS CERAMIC



UNTREATED TEAK  
PORTLAND CERAMIC





# KODO

Contemporary outdoor elegance which beckons both comfort and style.  
Designed by Studio Segers



MODULAR SOFA - DEEP SOFA - LOUNGE SOFA - LOUNGE CHAIR - COCOON - ROCKING CHAIR - FOOTREST  
SUNLOUNGER - SIDE TABLE - COFFEE TABLE - DAYBED - DINING CHAIR - DINING TABLE





KODO DEEP SOFA AND MODULAR SOFA dune white  
ROUND COFFEE TABLES dune white | ceramic portland





LEFT PAGE: KODO LOUNGE CHAIR, LOUNGE SOFA AND COFFEE TABLE dune white | ceramic shards  
RIGHT PAGE: KODO ROCKING CHAIR AND SIDE TABLE dune white | ceramic shards







KODO DAYBED fossil grey  
MORA LAMP MEDIUM AND LARGE





KODO LOUNGE CHAIR AND SOFA fossil grey  
KODO COFFEE TABLE AND SIDE TABLE fossil grey | ceramic flint



KODO DINING CHAIR fossil grey  
KODO DINING TABLE fossil grey | ceramic flint





LEFT PAGE: KODO COCOON dune white  
RIGHT PAGE: KODO SUNLOUNGER dune white

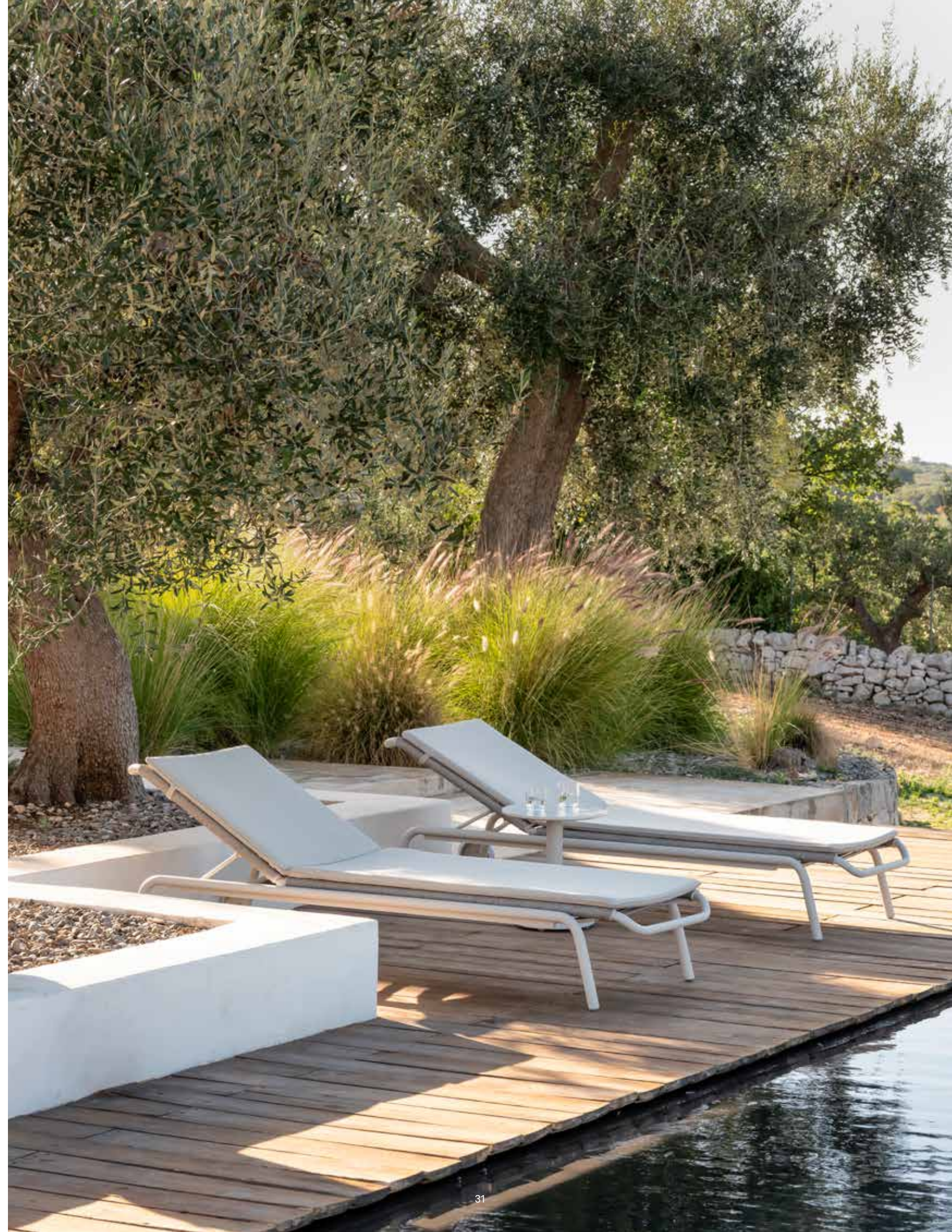





### KODO DINING CHAIR

**MATERIALS**  
powder coated aluminium  
polypropylene rope

**CUSHION**  
seat 4 cm quick dry foam

**COLOURS**  
   
FOSSIL GREY DUNE WHITE

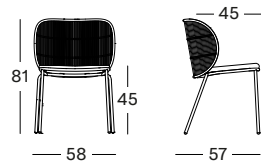

### KODO FOOTREST

**MATERIALS**  
powder coated aluminium

**CUSHION**  
footrest 12 cm quick dry foam

**COLOURS**  
   
FOSSIL GREY DUNE WHITE

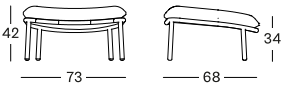

### KODO COCOON

**MATERIALS**  
powder coated aluminium  
polypropylene rope

**CUSHIONS**  
• seat 12 cm quick dry foam + deco 1x (60x60), 2x (40x40)  
• seat 12 cm quick dry foam +back polyester fibre filling and deco 1x (35x50)

**COLOURS**  
   
FOSSIL GREY DUNE WHITE

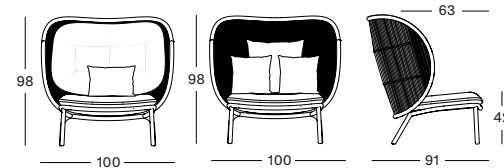

### KODO LOUNGE SOFA

**MATERIALS**  
powder coated aluminium  
polypropylene rope

**CUSHIONS**  
seat 12 cm quick dry foam  
deco 2x (50x50), 3x (40x40)

**COLOURS**  
   
FOSSIL GREY DUNE WHITE

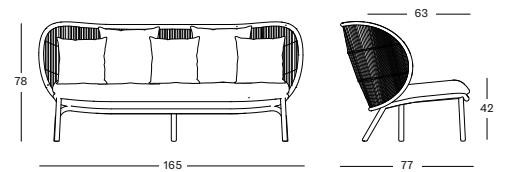

### KODO LOUNGE CHAIR

**MATERIALS**  
powder coated aluminium  
polypropylene rope

**CUSHIONS**  
seat 12 cm quick dry foam  
deco 1x (50x50), 1x (40x40)

**COLOURS**  
   
FOSSIL GREY DUNE WHITE

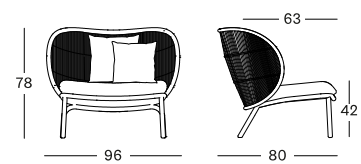

### KODO DAYBED

**MATERIALS**  
powder coated aluminium  
polypropylene rope

**CUSHIONS**  
seat 12 cm quick dry foam  
deco 2x (60x60), 3x (50x50), 2x (40x40)

**COLOURS**  
   
FOSSIL GREY DUNE WHITE

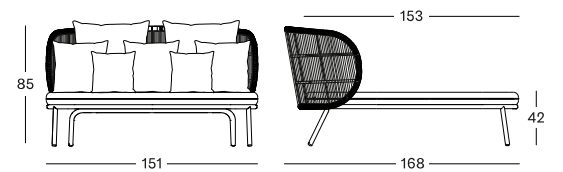

### KODO ROCKING CHAIR

**MATERIALS**  
powder coated aluminium and teak slats  
polypropylene rope

**CUSHIONS**  
• seat 12 cm quick dry foam + deco 1x (60 x 60), 2x (40 x 40)  
• seat 12 cm quick dry foam + back polyester fibre filling and deco 1x (35x50)

**COLOURS**  
   
FOSSIL GREY DUNE WHITE

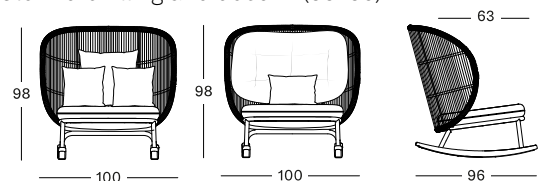

### KODO DINING TABLE

**MATERIALS**  
powder coated aluminium  
ceramic top

**DIMENSIONS**  
210 x 100 cm  
280 x 106 cm

**COLOURS**  
    
FOSSIL GREY FLINT DUNE WHITE SHARDS DUNE WHITE PORTLAND

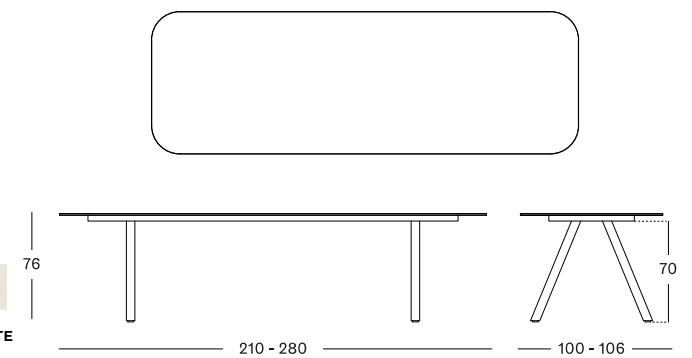





### KODO MODULAR 1 SEATER RIGHT

**MATERIALS**  
powder coated aluminium  
polypropylene rope

**CUSHION**  
seat 14 cm quick dry foam  
back polyester fibre filling

**COLOUR**



DUNE WHITE

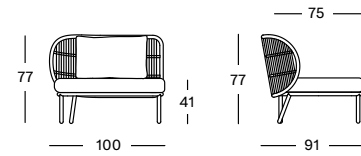

### KODO MODULAR 1 SEATER LEFT

**MATERIALS**  
powder coated aluminium  
polypropylene rope

**CUSHION**  
seat 14 cm quick dry foam  
back polyester fibre filling

**COLOUR**



DUNE WHITE

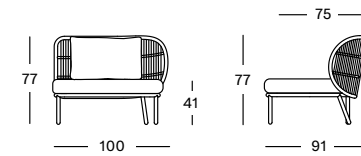

### KODO MODULAR 2 SEATER RIGHT

**MATERIALS**  
powder coated aluminium  
polypropylene rope

**CUSHIONS**  
seat 14 cm quick dry foam  
back polyester fibre filling

**COLOUR**



DUNE WHITE

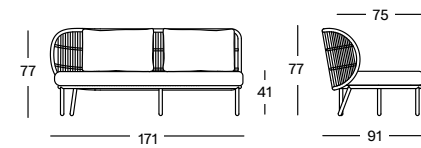

### KODO MODULAR 2 SEATER LEFT

**MATERIALS**  
powder coated aluminium  
polypropylene rope

**CUSHIONS**  
seat 14 cm quick dry foam  
back polyester fibre filling

**COLOUR**



DUNE WHITE

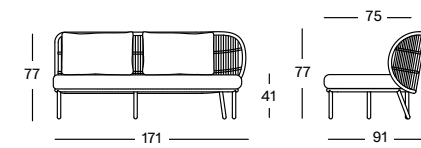

### KODO MODULAR CHAISE LONGUE RIGHT

**MATERIALS**  
powder coated aluminium  
polypropylene rope

**CUSHION**  
seat 14 cm quick dry foam  
back polyester fibre filling

**COLOUR**



DUNE WHITE

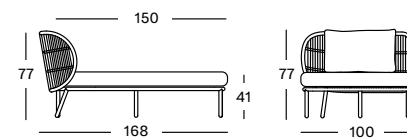

### KODO MODULAR CHAISE LONGUE LEFT

**MATERIALS**  
powder coated aluminium  
polypropylene rope

**CUSHION**  
seat 14 cm quick dry foam  
back polyester fibre filling

**COLOUR**



DUNE WHITE

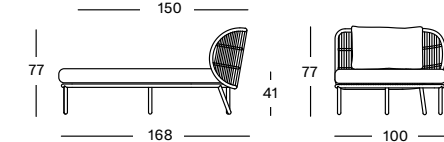

### KODO MODULAR CENTER

**MATERIALS**  
powder coated aluminium  
polypropylene rope

**CUSHIONS**  
seat 14 cm quick dry foam  
back polyester fibre filling

**COLOUR**



DUNE WHITE

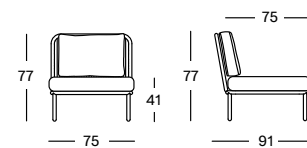

### KODO MODULAR CORNER

**MATERIALS**  
powder coated aluminium  
polypropylene rope

**CUSHIONS**  
seat 14 cm quick dry foam  
back polyester fibre filling

**COLOUR**



DUNE WHITE

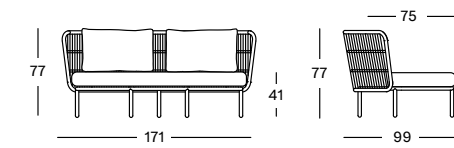





### KODO DEEP SOFA

#### MATERIALS

powder coated aluminium  
polypropylene rope

#### CUSHIONS

seat 14 cm quick dry foam  
back polyester fibre filling

#### COLOURS



FOSSIL GREY DUNE WHITE

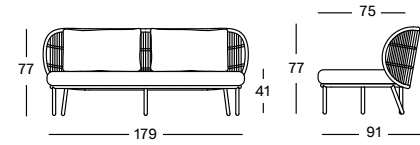

### KODO ROUND COFFEE TABLE DIA 68 & DIA 90

#### MATERIALS

- powder coated aluminium with aluminium top
- powder coated aluminium with ceramic top

#### DIMENSIONS

36 cm H x Ø 68 cm  
30 cm H x Ø 90 cm

#### COLOURS



FOSSIL GREY FLINT CERAMIC DUNE WHITE SHARDS CERAMIC DUNE WHITE PORTLAND CERAMIC

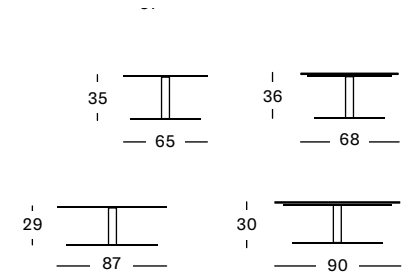

### KODO MODULAR OTTOMAN

#### MATERIALS

powder coated aluminium

#### CUSHIONS

seat 14 cm quick dry foam

#### COLOUR



DUNE WHITE

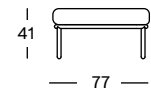

### KODO COFFEE TABLE

#### MATERIALS

- powder coated aluminium with aluminium top
- powder coated aluminium with ceramic top

#### DIMENSIONS

129 x 45 cm

#### COLOURS



FOSSIL GREY FLINT CERAMIC DUNE WHITE SHARDS CERAMIC DUNE WHITE PORTLAND CERAMIC

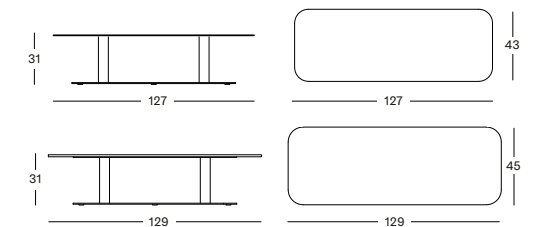

### KODO MODULAR CONNECTING SIDE TABLE

#### MATERIALS

powder coated aluminium

#### DIMENSIONS

75 x 75 cm  
75 x 59 cm

#### COLOUR



DUNE WHITE

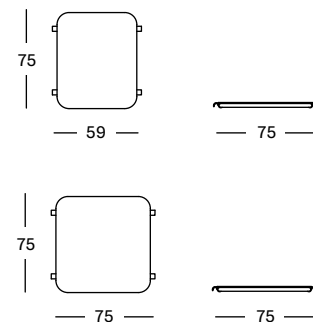

### KODO SIDE TABLE

#### MATERIALS

- powder coated aluminium with aluminium top
- powder coated aluminium with ceramic top

#### DIMENSIONS

41 x 41 cm

#### COLOURS



FOSSIL GREY FLINT CERAMIC DUNE WHITE SHARDS CERAMIC DUNE WHITE PORTLAND CERAMIC

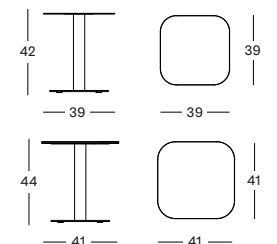

### KODO ROUND SIDE TABLE

#### MATERIALS

- powder coated aluminium with aluminium top
- powder coated aluminium with ceramic top

#### DIMENSIONS

44 cm H x Ø 40 cm

#### COLOURS



FOSSIL GREY FLINT CERAMIC DUNE WHITE SHARDS CERAMIC DUNE WHITE PORTLAND CERAMIC

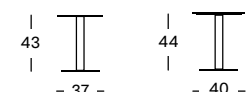

### KODO SUNLOUNGER

#### MATERIALS

powder coated aluminium  
polypropylene fibre

#### CUSHIONS

3 cm polyether foam filling

#### COLOURS



FOSSIL GREY DUNE WHITE

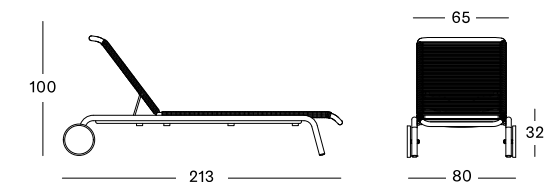



# LENTO

Prominently featured solid teak legs and high woven rope backs give the collection a rich and engaging personality. Designed by Bertrand Lejoly



LOUNGE CHAIR - LOUNGE SOFA - MODULAR SOFA  
MODULAR CHAISE LONGUE- COFFEE TABLE - SIDE TABLE





LENTO LOUNGE CHAIR, MODULAR SOFA AND COFFEE TABLES





LENTO LOUNGE SOFA 2,5S  
COFFEE AND SIDE TABLES

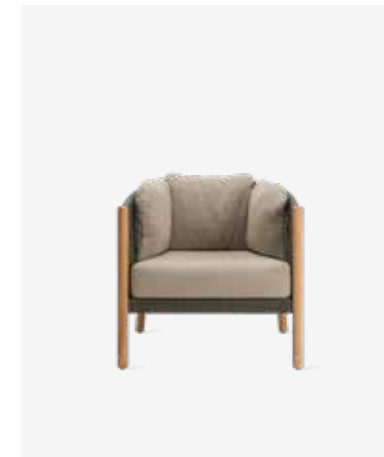

### LENTO LOUNGE CHAIR

#### MATERIALS

untreated teak  
polypropylene rope

#### CUSHIONS

seat 12 cm quick dry foam  

- back polyester fibre filling
- deco 1 x (50 x 50), 1 x (40 x 40)

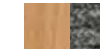

UNTREATED TEAK  
ANTHRACITE ROPE

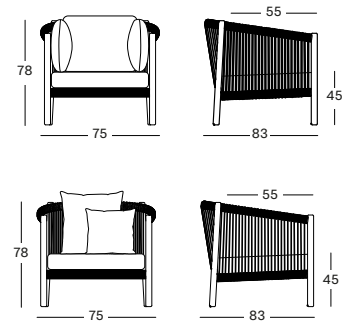

### LENTO LOUNGE SOFA 2.5S

#### MATERIALS

untreated teak  
polypropylene rope

#### CUSHIONS

seat 12 cm quick dry foam  
back polyester fibre filling

#### COLOUR



UNTREATED TEAK  
ANTHRACITE ROPE

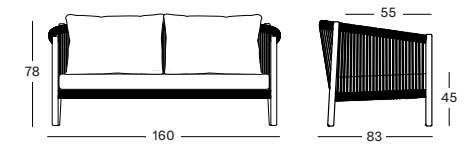

### LENTO LOUNGE SOFA 3S

#### MATERIALS

untreated teak  
polypropylene rope

#### CUSHIONS

seat 12 cm quick dry foam  
back polyester fibre filling

#### COLOUR



UNTREATED TEAK  
ANTHRACITE ROPE

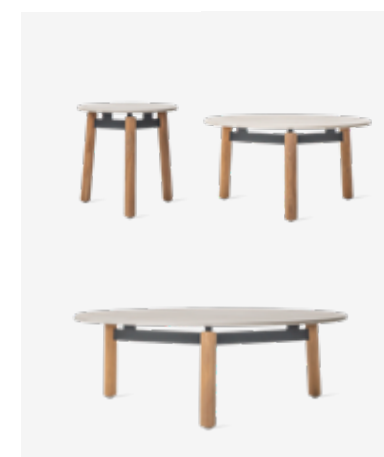
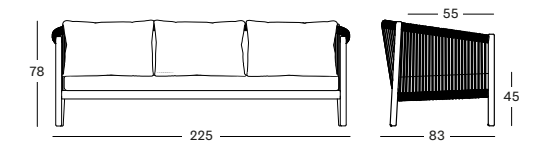

### LENTO COFFEE AND SIDE TABLES

#### MATERIALS

untreated teak and aluminium frame  
ceramic top

#### DIMENSIONS

44 cm H x Ø 45 cm  
34 cm H x Ø 68 cm  
29 cm H x Ø 90 cm



UNTREATED TEAK  
PORTLAND CERAMIC

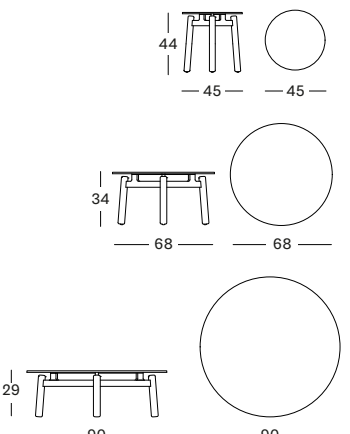





### LENTO MODULAR CORNER RIGHT

**MATERIALS**  
untreated teak  
polypropylene rope

**CUSHIONS**  
seat 12 cm quick dry foam  
back polyester fibre filling

**COLOUR**  
  
UNTREATED TEAK  
ANTHRACITE ROPE

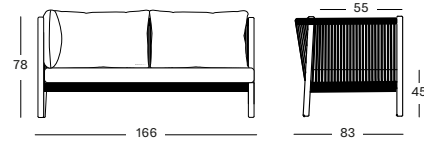

### LENTO MODULAR CHAISE LONGUE LEFT

**MATERIALS**  
untreated teak  
polypropylene rope

**CUSHIONS**  
seat 12 cm quick dry foam  
back polyester fibre filling

**COLOUR**  
  
UNTREATED TEAK  
ANTHRACITE ROPE

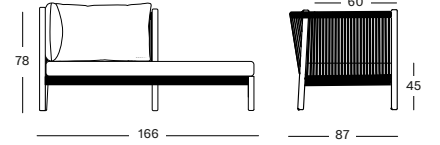

### LENTO MODULAR CORNER LEFT

**MATERIALS**  
untreated teak  
polypropylene rope

**CUSHIONS**  
seat 12 cm quick dry foam  
back polyester fibre filling

**COLOUR**  
  
UNTREATED TEAK  
ANTHRACITE ROPE

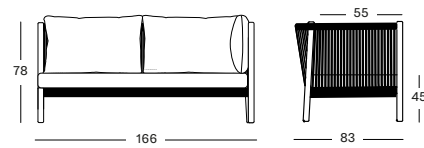

### LENTO MODULAR CHAISE LONGUE RIGHT

**MATERIALS**  
untreated teak  
polypropylene rope

**CUSHIONS**  
seat 12 cm quick dry foam  
back polyester fibre filling

**COLOUR**  
  
UNTREATED TEAK  
ANTHRACITE ROPE

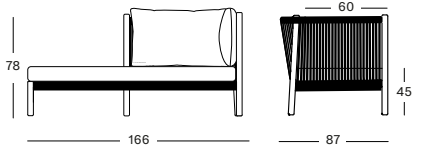

### LENTO MODULAR CONNECTING SIDE TABLE

**MATERIALS**  
polypropylene rope  
ceramic top

**DIMENSIONS**  
69 x 37 cm

**COLOUR**  
  
PORTLAND CERAMIC  
ANTHRACITE ROPE

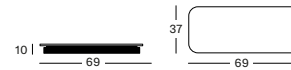

### LENTO MODULAR OTTOMAN

**MATERIALS**  
untreated teak  
polypropylene rope

**CUSHIONS**  
seat 12 cm quick dry foam

**COLOUR**  
  
UNTREATED TEAK  
ANTHRACITE ROPE

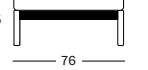



# CLEO

A stylish blend of lightweight aluminum and comfortable woven rope for your outdoor spaces.



LOUNGE CHAIR - LOUNGE SOFA





CLEO LOUNGE CHAIR AND SOFA dune white  
LILO COFFEE AND SIDE TABLE dune white





CLEO DINING CHAIR dune white  
MATTEO DINING TABLE





CLEO DINING CHAIR dune white  
KODO DINING TABLE dune white | ceramic portland



### CLEO DINING ARMCHAIR

**MATERIALS**  
polypropylene rope  
powder coated aluminium frame

**CUSHIONS**  
2 cm polyether foam

#### COLOUR



DUNE WHITE/  
DUNE WHITE    FOSSIL GREY/  
MISTY DOTS    SAGE GREEN/  
MISTY DOTS

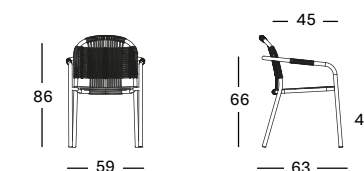

### CLEO LOUNGE CHAIR

**MATERIALS**  
polypropylene rope  
powder coated aluminium frame

**CUSHIONS**  
3 cm quick dry foam

#### COLOUR



DUNE WHITE/  
DUNE WHITE    FOSSIL GREY/  
MISTY DOTS    SAGE GREEN/  
MISTY DOTS

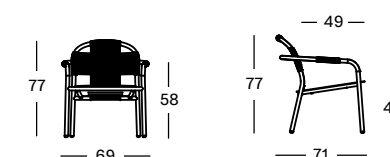

### CLEO LOUNGE SOFA

**MATERIALS**  
polypropylene rope  
powder coated aluminium frame

**CUSHIONS**  
3 cm quick dry foam

#### COLOUR



DUNE WHITE/  
DUNE WHITE    FOSSIL GREY/  
MISTY DOTS    SAGE GREEN/  
MISTY DOTS

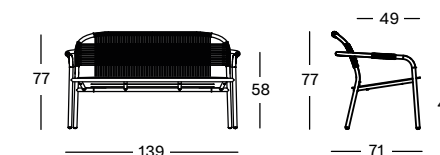

### LILO COFFEE & SIDE TABLES

**MATERIALS**  
powder coated aluminium frame

**DIMENSIONS**  
44 cm H x Ø 45 cm  
36 cm H x Ø 60 cm  
30 cm H x Ø 68 cm

#### COLOUR



DUNE  
WHITE    FOSSIL  
GREY    SAGE  
GREEN

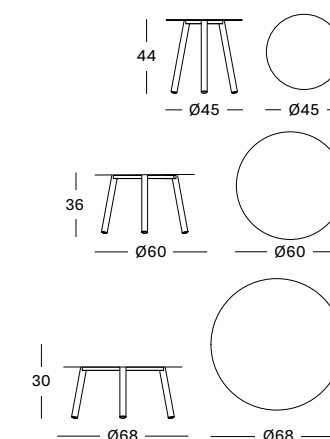



# FREYA MONA NOA REMI VOLTA

Renowned for its resilience and timeless beauty, teak has the power to transform any space into a sanctuary of elegance.











REMI DINING CHAIR fossil grey  
NOA DINING TABLE





MONA DINING CHAIR old lace







### VOLTA DINING TABLE

#### MATERIALS

ceramic top  
untreated teak frame

#### DIMENSIONS

240 x 100 cm  
310 x 100 cm

#### COLOUR



UNTREATED TEAK  
MASAI BLANCO CERAMIC

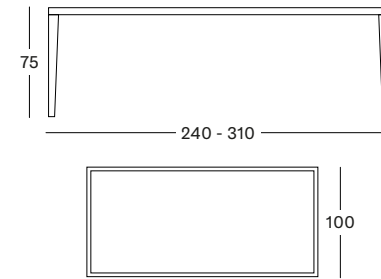

### MONA DINING CHAIR TEAK

#### MATERIALS

polyethylene wicker seat  
untreated teak base

#### CUSHIONS

2 cm polyether foam

#### COLOUR



UNTREATED TEAK  
OLD LACE WICKER

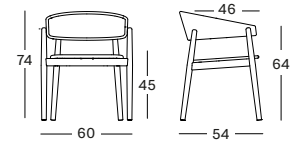

### SAM DINING TABLE

#### MATERIALS

untreated solid teak

#### DIMENSIONS

75 cm H x Ø 120 cm

#### COLOUR



UNTREATED TEAK

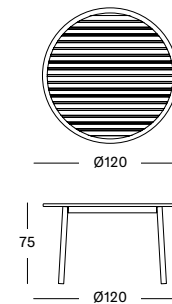

### MONA DINING CHAIR BLACK STAINED BRUSHED TEAK

#### MATERIALS

polyethylene wicker seat  
brushed teak base

#### CUSHIONS

2 cm polyether foam

#### COLOUR



BLACK BRUSHED TEAK  
BLACK WICKER

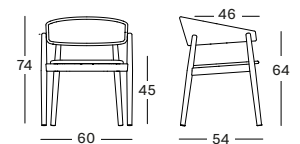

### NOA DINING TABLE

#### MATERIALS

untreated solid teak  
powder coated aluminium connection

#### DIMENSIONS

75 cm H x Ø 90 cm  
75 cm H x Ø 132 cm  
75 cm H x Ø 150 cm

#### COLOUR



UNTREATED TEAK

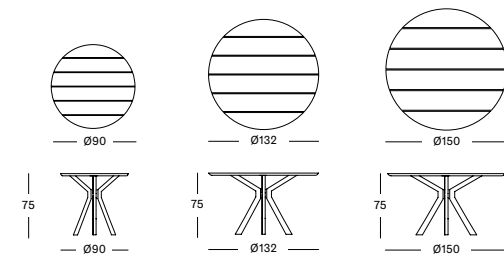

### REMI DINING CHAIR TEAK BASE

#### MATERIALS

aluminium and polypropylene rope seat  
teak base

#### CUSHIONS

2 cm polyether foam

#### COLOURS



UNTREATED TEAK  
FOSSIL GREY    UNTREATED TEAK  
DUNE WHITE

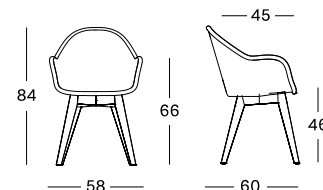

### FREYA DINING ARMCHAIR

#### MATERIALS

untreated solid teak

#### CUSHION

seat 2 cm polyether foam

#### COLOUR



UNTREATED TEAK

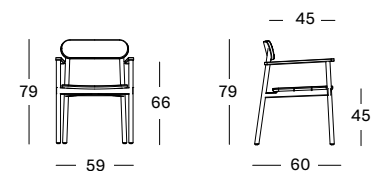

### REMI DINING CHAIR STEEL A BASE

#### MATERIALS

aluminium and polypropylene rope seat  
black epoxy coated steel base

#### CUSHIONS

2 cm polyether foam

#### COLOURS



BLACK STEEL  
FOSSIL GREY    BLACK STEEL  
DUNE WHITE

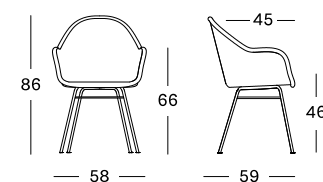



# LEO

The comfortable seating of the tub chair, the laid-back shape of the sofa, and the playful weaving turn it into a real eye catcher.



LOUNGE CHAIR - LOUNGE SOFA - MODULAR SOFA  
SIDE TABLE - COFFEE TABLE - DINING CHAIR - DINING TABLE





LEO LOUNGE CHAIR, MODULAR SOFA AND COFFEE TABLES  
TOUNDRA RUG sahara





LEFT PAGE: LEO DINING CHAIR AND DINING TABLE  
RIGHT PAGE: LEO LOUNGE CHAIR, SOFA AND COFFEE TABLES







### LEO MODULAR CORNER LEFT

#### MATERIALS

powder coated aluminium  
acrylic rope

#### CUSHIONS

seat 12 cm quick dry foam  
back polyester fibre filling + deco 1x (50x50), 1x (40x40)

#### COLOUR

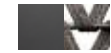

LAVA ALUMINIUM  
LAVA ROPE

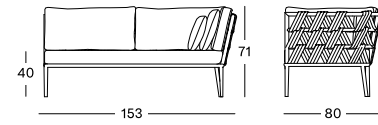

### LEO LOUNGE CHAIR

#### MATERIALS

powder coated aluminium  
acrylic rope

#### CUSHIONS

seat 12 cm quick dry foam  
back polyester fibre filling

#### COLOUR



LAVA ALUMINIUM  
LAVA ROPE

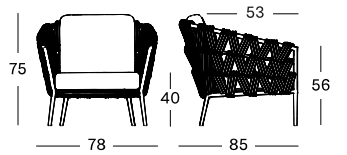

### LEO MODULAR CORNER RIGHT

#### MATERIALS

powder coated aluminium  
acrylic rope

#### CUSHIONS

seat 12 cm quick dry foam  
back polyester fibre filling + deco 1x (50x50), 1x (40x40)

#### COLOUR

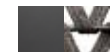

LAVA ALUMINIUM  
LAVA ROPE

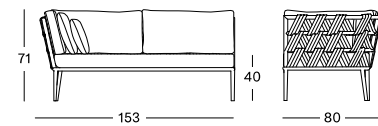

### LEO LOUNGE SOFA

#### MATERIALS

powder coated aluminium  
acrylic rope

#### CUSHIONS

seat 12 cm quick dry foam  
back polyester fibre filling

#### COLOUR



LAVA ALUMINIUM  
LAVA ROPE

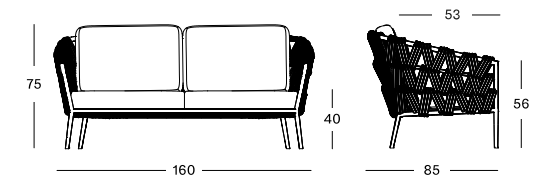

### LEO MODULAR CENTER

#### MATERIALS

powder coated aluminium  
acrylic rope

#### CUSHIONS

seat 12 cm quick dry foam  
back polyester fibre filling

#### COLOUR



LAVA ALUMINIUM  
LAVA ROPE

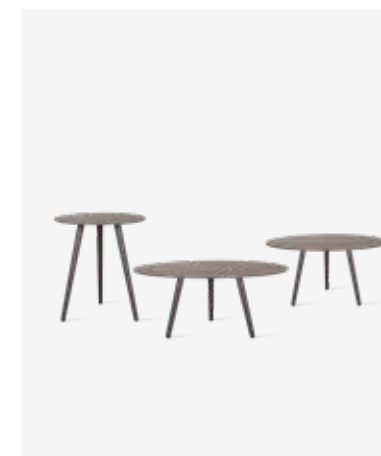
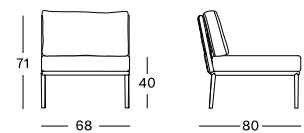

### LEO COFFEE AND SIDE TABLES

#### MATERIALS

powder coated aluminium

#### DIMENSIONS

48 cm H x Ø 45 cm  
32 cm H x Ø 60 cm  
38 cm H x Ø 70 cm

#### COLOUR

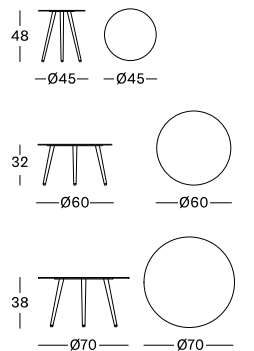

### LEO MODULAR FOOTREST

#### MATERIALS

powder coated aluminium

#### CUSHION

seat 12 cm quick dry foam

#### COLOUR



LAVA ALUMINIUM  
UNTREATED TEAK

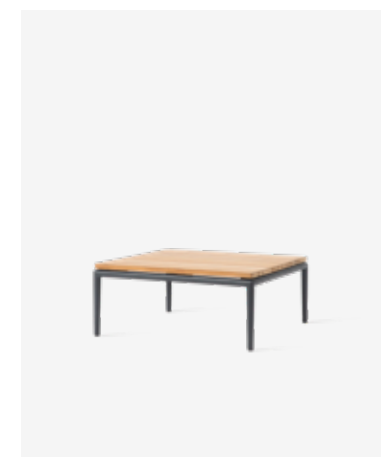
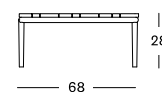

### LEO MODULAR COFFEE TABLE

#### MATERIALS

powder coated aluminium  
untreated teak

#### DIMENSIONS

68 x 68 cm

#### COLOUR



LAVA ALUMINIUM  
UNTREATED TEAK

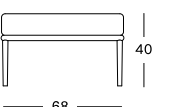





### LEO DINING CHAIR

**MATERIALS**  
powder coated aluminium  
acrylic rope

**CUSHIONS**  
seat 4 cm quick dry foam  
back polyester fibre filling

#### COLOUR

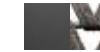

LAVA ALUMINIUM

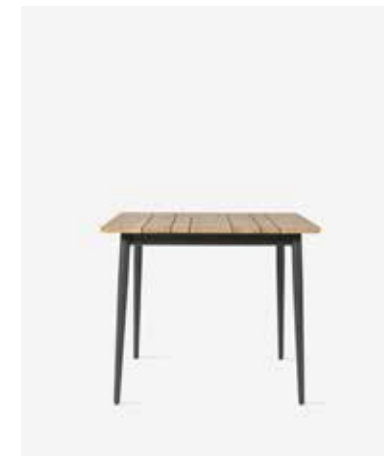
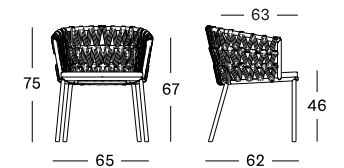

### LEO DINING TABLE 90x90

**MATERIALS**  
powder coated aluminium  
untreated teak top

**DIMENSIONS**  
90 x 90 cm

#### COLOUR



LAVA ALUMINIUM  
UNTREATED TEAK

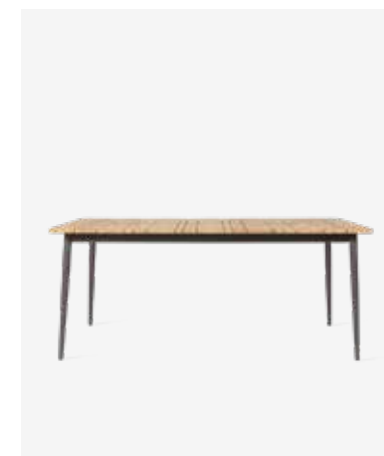
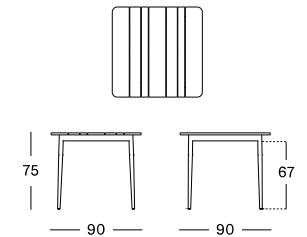

### LEO DINING TABLE

**MATERIALS**  
powder coated aluminium  
untreated teak top

**DIMENSIONS**  
180 x 90 cm  
240 x 100 cm

#### COLOUR



LAVA ALUMINIUM  
UNTREATED TEAK

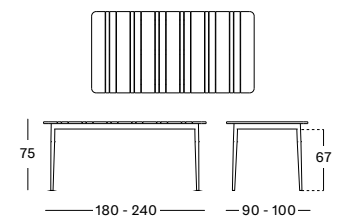

### MAX DINING TABLE

**MATERIALS**  
powder coated aluminium frame  
untreated teak top or black hpl top (90x90)

**DIMENSIONS**  
90 x 90 cm (top also available in hpl)  
180 x 90 cm  
240 x 100 cm



BLACK/  
UNTREATED TEAK



BLACK/HPL



FOSSIL GREY/  
UNTREATED TEAK



FOSSIL GREY/HPL



DUNE WHITE/  
UNTREATED TEAK



DUNE WHITE/HPL

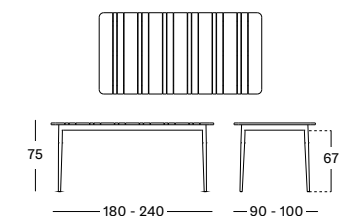
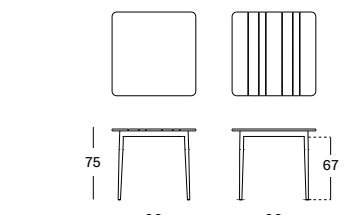





### TOUNDRA OUTDOOR RUG

**MATERIALS**  
polyester fibre

**DIMENSIONS**  
170 x 240 cm  
200 x 300 cm  
250 x 350 cm

**COLOURS**  
  
SAHARA



### CLIFF OUTDOOR RUG

**MATERIALS**  
polyester fibre

**DIMENSIONS**  
170 x 240 cm  
200 x 300 cm  
250 x 350 cm

**COLOURS**  
  
CLAY



CLIFF RUG AND ROZY COFFEE TABLE



# DAVID

David's woven back and rope details in a soft earthy tone match perfectly with the solid teak frame and add a sense of tactility.



LOUNGE CHAIR - LOUNGE SOFA - COFFEE TABLE - SIDE TABLE  
DINING CHAIR - DINING TABLE - SUNLOUNGER





DAVID LOUNGE SOFA 2S, LOUNGE CHAIR, COFFEE AND SIDE TABLE  
TOUNDRA RUG sahara





LEFT PAGE: DAVID DINING CHAIR AND DINING TABLE  
RIGHT PAGE: DAVID SUNLOUNGER







### DAVID DINING ARMCHAIR

**MATERIALS**  
stained brushed teak  
polypropylene rope

**CUSHION**  
4 cm quick dry foam

**COLOUR**



AGED TEAK

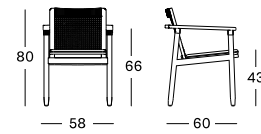

### DAVID LOUNGE CHAIR

**MATERIALS**  
stained brushed teak  
polypropylene rope

**CUSHIONS**  
seat 12 cm quick dry foam  
back polyester fibre filling

**COLOUR**



AGED TEAK

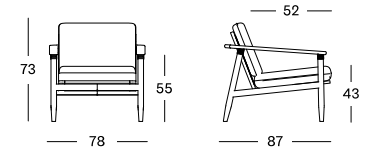

### DAVID DINING TABLE

**MATERIALS**  
stained brushed teak  
ceramic top

**DIMENSIONS**  
210 x 100 cm  
280 x 106 cm

**COLOUR**



AGED TEAK  
FLINT CERAMIC

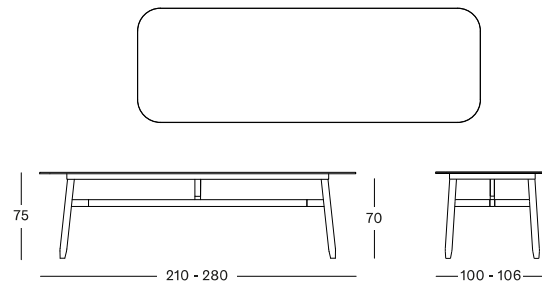

### DAVID LOUNGE SOFA 2S

**MATERIALS**  
stained brushed teak  
polypropylene rope

**CUSHIONS**  
seat 12 cm quick dry foam  
back polyester fibre filling

**COLOUR**



AGED TEAK

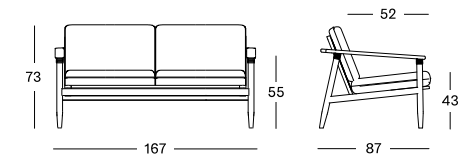

### DAVID SUNLOUNGER

**MATERIALS**  
stained brushed teak  
polypropylene rope

**CUSHION**  
6 cm quick dry foam

**COLOUR**



AGED TEAK

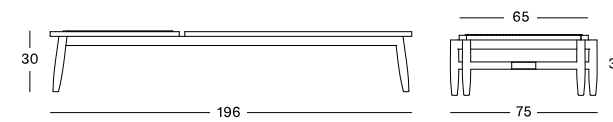

### DAVID LOUNGE SOFA 3S

**MATERIALS**  
stained brushed teak  
polypropylene rope

**CUSHIONS**  
seat 12 cm quick dry foam  
back polyester fibre filling

**COLOUR**



AGED TEAK

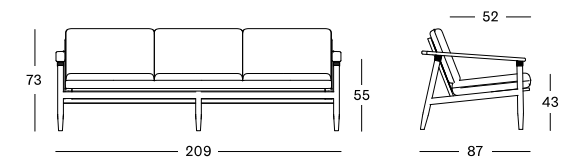

### DAVID ROUND COFFEE & SIDE TABLE

**MATERIALS**  
stained brushed teak  
ceramic top

**DIMENSIONS**  
side table: 40 cm H x Ø 40 cm  
coffee table: 34 cm H x Ø 68 cm

**COLOUR**



AGED TEAK  
FLINT CERAMIC

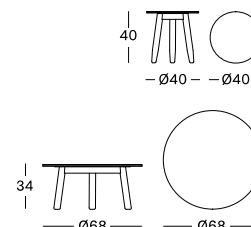

### DAVID COFFEE AND SIDE TABLES

**MATERIALS**  
stained brushed teak  
ceramic top

**DIMENSIONS**  
side table: 41 x 41 cm  
coffee table: 120 x 120 cm  
coffee table: 129 x 45 cm

**COLOUR**



AGED TEAK  
FLINT CERAMIC

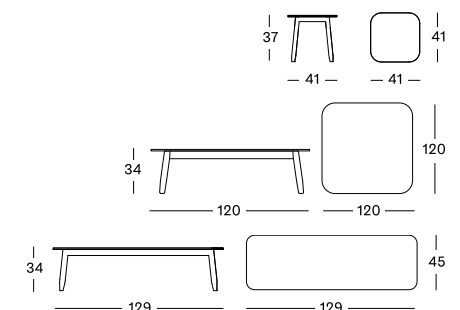



# LOOP

Through its slim profile and see-through weave, which balances utter comfort with ample spatiality, the Loop collection is a symbol of attractive yet functional design.



SOFA - LOUNGE CHAIR - FOOTREST - SUNLOUNGER  
SIDE TABLE - COFFEE TABLE - DINING CHAIR





LEFT PAGE: LOOP LOUNGE CHAIR AND LILO SIDE TABLE dune white  
RIGHT PAGE: LOOP DINING CHAIR moss







LOOP SOFA, LOUNGE CHAIR, COFFEE AND SIDE TABLE fossil grey





### LOOP FOOTREST

#### MATERIALS

- powder coated aluminium
- polyethylene fibre (black)
- polypropylene rope (other colours)

#### COLOURS

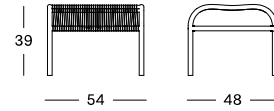

### LOOP DINING CHAIR

#### MATERIALS

- powder coated aluminium
- polyethylene fibre (black)
- polypropylene rope (other colours)

#### COLOURS

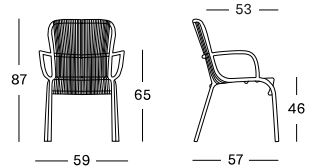

### LOOP SIDE TABLE

#### MATERIALS

- powder coated aluminium
- polyethylene fibre (black)
- polypropylene rope (other colours)

#### COLOURS

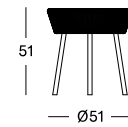

### LOOP LOUNGE CHAIR

#### MATERIALS

- powder coated aluminium
- polyethylene fibre (black)
- polypropylene rope (other colours)

#### COLOURS

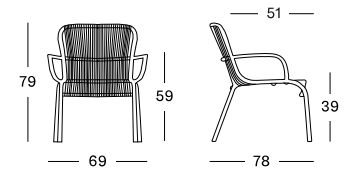

### LOOP COFFEE TABLE

#### MATERIALS

- powder coated aluminium
- polyethylene fibre (black)
- polypropylene rope (other colours)

#### COLOURS

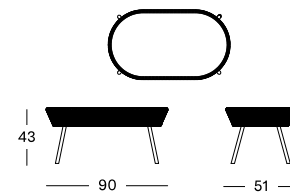

### LOOP SOFA

#### MATERIALS

- powder coated aluminium
- polyethylene fibre (black)
- polypropylene rope (other colours)

#### COLOURS

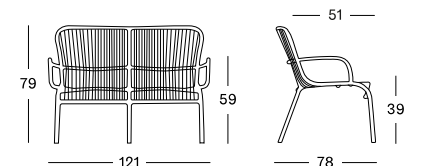

### LOOP SUNLOUNGER

#### MATERIALS

- powder coated aluminium
- polyethylene fibre (black)
- polypropylene rope (other colours)

#### CUSHIONS

3 cm polyether foam

#### COLOURS

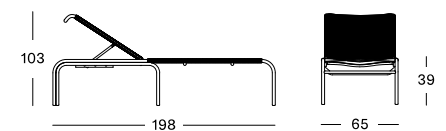



# LIGHTING

Extend the evenings and illuminate your outdoor experience with stunning lighting designs.



MAYA - TIKA - MORA - LIGHT MY TABLE







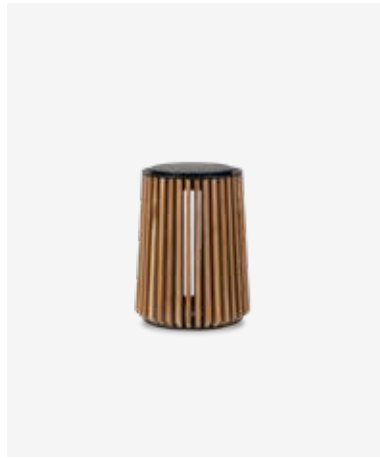

### MAYA LAMP SMALL

#### MATERIALS

repurposed teak slats  
casted aluminium frame  
solar-powered LED module

#### DIMENSIONS

34 cm H x Ø 27 cm

#### COLOUR



UNTREATED TEAK  
BLACK ALUMINIUM

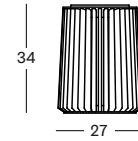

### MAYA LAMP LARGE

#### MATERIALS

repurposed teak slats  
casted aluminium frame  
solar-powered LED module

#### DIMENSIONS

48 cm H x Ø 28 cm

#### COLOUR



UNTREATED TEAK  
BLACK ALUMINIUM

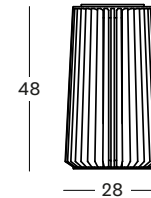



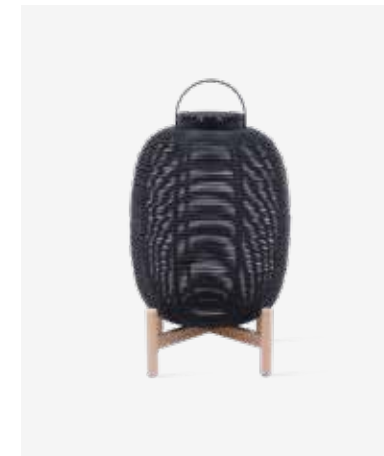
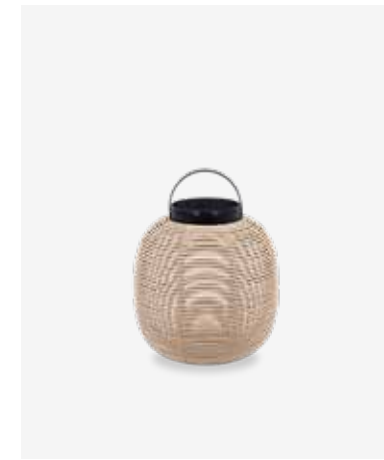

## TIKA LANTERN

### MATERIALS

powder coated aluminium with HDPE wicker  
solar-powered LED module

### DIMENSIONS

40 cm H x Ø 35 cm  
59 cm H x Ø 47 cm

### COLOURS



CAMEL



BLACK

## TIKA LANTERN STEEL BASE

### MATERIALS

powder coated aluminium with HDPE wicker  
solar-powered LED module  
powder coated steel base

### DIMENSIONS

59 cm H x Ø 35 cm  
69 cm H x Ø 47 cm

### COLOURS



CAMEL / BLACK



BLACK / BLACK

## TIKA LANTERN TEAK BASE

### MATERIALS

powder coated aluminium with HDPE wicker  
solar-powered LED module  
untreated teak base

### DIMENSIONS

59 cm H x Ø 35 cm  
69 cm H x Ø 47 cm

### COLOUR



BLACK / UNTREATED TEAK

## LIGHT MY TABLE

### MATERIALS

black powder coated  
galvanized steel  
leather details  
9 LED lamps 2W

### DIMENSIONS

adjustable 200 – 300 cm  
(for table tops up to 6 cm thick)

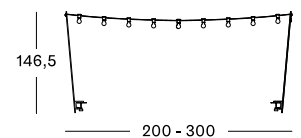
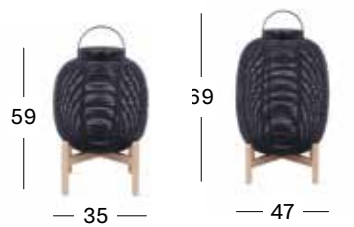
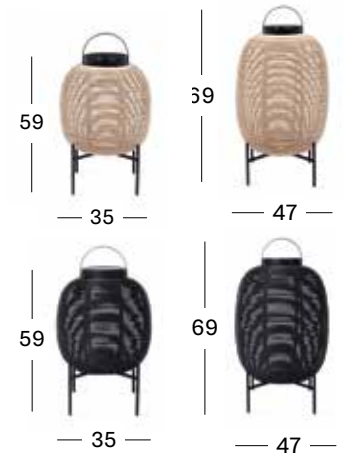





### MORA LAMP WITH HANDLE 54 CM H

#### MATERIALS

powder coated steel  
polypropylene rope  
solar-powered LED module

#### DIMENSIONS

54 cm H x Ø 26 cm

#### COLOUR



FOSSIL GREY ROPE

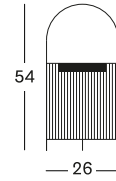

### MORA LAMP 42 CM H X 54 CM DIA

#### MATERIALS

powder coated steel  
polypropylene rope  
solar-powered LED module

#### DIMENSIONS

42 cm H x Ø 54 cm

#### COLOUR



FOSSIL GREY ROPE

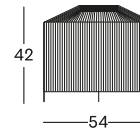

### MORA LAMP 61 CM H X 40 CM DIA

#### MATERIALS

powder coated steel  
polypropylene rope  
solar-powered LED module

#### DIMENSIONS

61 cm H x Ø 40 cm

#### COLOUR



FOSSIL GREY ROPE

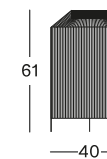



# ROY

The Roy collection combines nostalgic design with innovative materials, giving your outdoor space a strong graphic twist.



LAZY CHAIR - COCOON - DINING CHAIR





LEFT PAGE: ROXY DINING CHAIR black, RONDA BISTRO TABLE AND MAYA LAMP SMALL  
RIGHT PAGE: ROXANNE DINING CHAIR black AND RONDA BISTRO TABLE







LEFT PAGE: ROY COCOON black  
RIGHT PAGE: ROY LAZY CHAIR camel





### SPHERA BISTRO TABLE

#### MATERIALS

black epoxy coated steel base  
untreated teak or black hpl top

#### DIMENSIONS

Ø 80 cm

#### COLOURS



UNTREATED TEAK    BLACK HPL

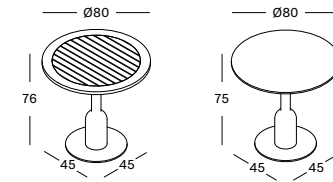

### ROXANNE DINING CHAIR

#### MATERIALS

aluminium and polyethylene wicker seat  
black epoxy coated steel base

#### CUSHIONS

seat 2 cm polyether foam

#### COLOURS



CAMEL WICKER    BLACK WICKER

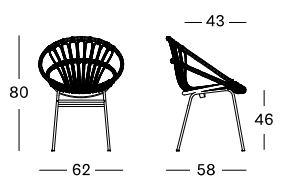

### RONDA BISTRO TABLE

#### MATERIALS

black epoxy coated steel base  
untreated teak top or black HPL top

#### DIMENSIONS

Ø 110 cm

#### COLOURS



UNTREATED TEAK    BLACK HPL

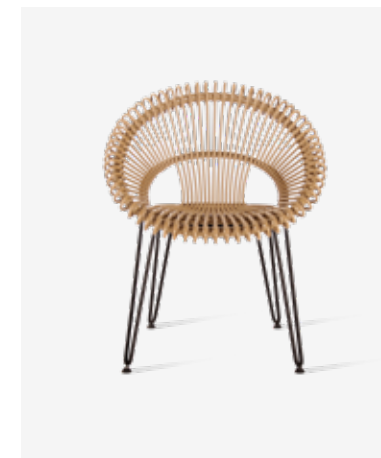
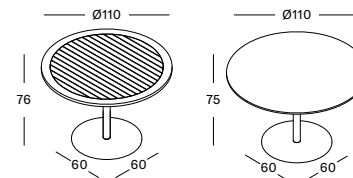

### ROXY DINING CHAIR

#### MATERIALS

aluminium and polyethylene wicker seat  
black epoxy coated steel base

#### CUSHIONS

seat 2 cm polyether foam

#### COLOURS



CAMEL WICKER    BLACK WICKER

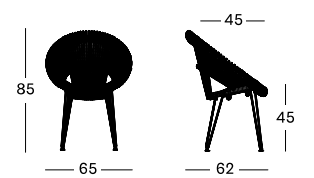

### QUADRO BISTRO TABLE

#### MATERIALS

black powder coated steel base  
untreated teak or hpl top

#### DIMENSIONS

70 x 70 cm

#### COLOURS



UNTREATED TEAK    BLACK HPL

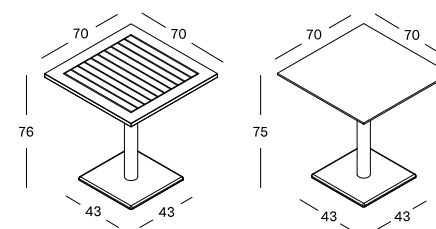

### ROY LAZY CHAIR

#### MATERIALS

aluminium and polyethylene wicker seat  
black epoxy coated steel base

#### CUSHIONS

seat 2 cm polyether foam

#### COLOURS



CAMEL WICKER    BLACK WICKER

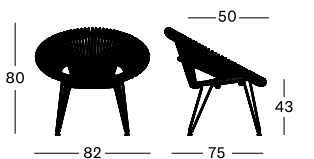

### MAX DINING TABLE

#### MATERIALS

powder coated aluminium frame  
untreated teak top or black hpl top (90x90)

#### DIMENSIONS

90 x 90 cm (also available in hpl)

180 x 90 cm

240 x 100 cm



BLACK/UNTREATED TEAK



FOSSIL GREY/UNTREATED TEAK



DUNE WHITE/UNTREATED TEAK



BLACK/HPL



FOSSIL GREY/HPL



DUNE WHITE/HPL

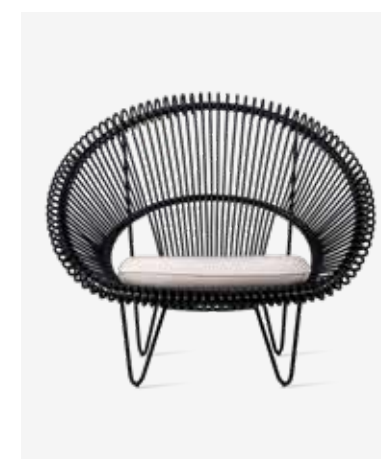
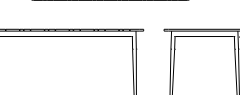
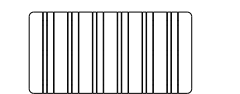
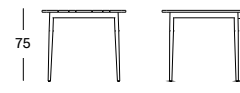
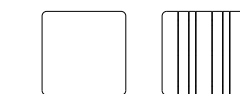

### ROY COCOON

#### MATERIALS

aluminium and polyethylene wicker seat  
black epoxy coated steel base

#### CUSHIONS

seat 8 cm quick dry foam

#### COLOURS



CAMEL WICKER    BLACK WICKER

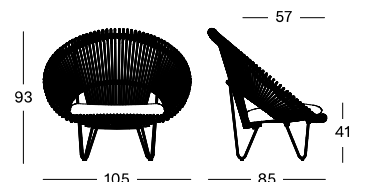





### ROZY SIDE TABLE

**MATERIALS**  
epoxy coated steel  
black hpl

**DIMENSIONS**  
50 x 49 x 42 cm

**COLOUR**  
  
BLACK HPL

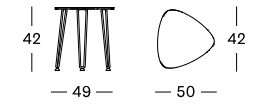

### ROZY COFFEE TABLE

**MATERIALS**  
epoxy coated steel  
black hpl

**DIMENSIONS**  
99 x 114 x 72 cm

**COLOUR**  
  
BLACK HPL

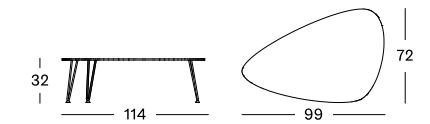



# WICKED

By creating an unexpectedly light and airy shape, Belgian designer Alain Gilles managed to shed new light onto the traditional wicker furniture.







WICKED LOUNGE SOFA 2S AND LOUNGE CHAIR taupe  
COFFEE AND SIDE TABLE





WICKED LOUNGE CHAIR taupe



WICKED DINING CHAIR taupe  
WICKED DINING TABLE





### WICKED DINING CHAIR

**MATERIALS**  
powder coated aluminium  
polyethylene wicker

**CUSHIONS**  
2 cm polyether foam

**COLOURS**



BLACK  
TAUPE      WHITE  
NATURAL

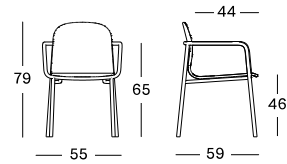

### WICKED LOUNGE CHAIR

**MATERIALS**  
powder coated aluminium  
polyethylene wicker

**CUSHIONS**  
seat 10 cm quick dry foam  
deco 1 x (40x40)

**COLOURS**



BLACK  
TAUPE      WHITE  
NATURAL

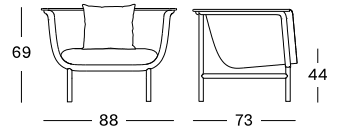

### WICKED DINING TABLE

**MATERIALS**  
powder coated aluminium  
untreated teak

**DIMENSIONS**  
200 x 90 cm  
250 x 90 cm

**COLOURS**



BLACK ALUMINIUM  
UNTREATED TEAK      WHITE ALUMINIUM  
UNTREATED TEAK

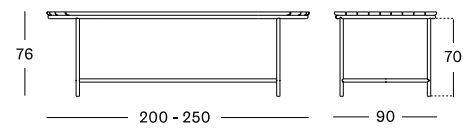
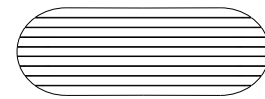

### WICKED LOUNGE SOFA 2S

**MATERIALS**  
powder coated aluminium  
polyethylene wicker

**CUSHIONS**  
seat 10 cm quick dry foam  
deco 2x (45x50), 3x (40x40)

**COLOURS**



BLACK  
TAUPE      WHITE  
NATURAL

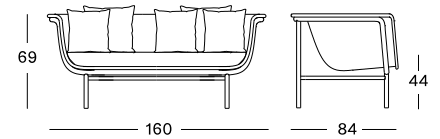

### WICKED SIDE TABLE

**MATERIALS**  
powder coated aluminium  
untreated teak

**DIMENSIONS**  
Ø 37 cm

**COLOURS**

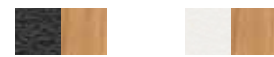

BLACK ALUMINIUM  
UNTREATED TEAK      WHITE ALUMINIUM  
UNTREATED TEAK

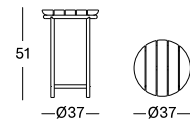

### WICKED LOUNGE SOFA 3S

**MATERIALS**  
powder coated aluminium  
polyethylene wicker

**CUSHIONS**  
seat 10 cm quick dry foam  
deco 3x (45x50), 2x (40x40)

**COLOURS**



BLACK  
TAUPE      WHITE  
NATURAL

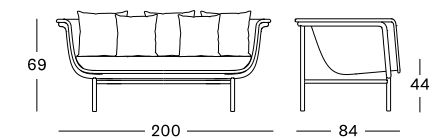

### WICKED COFFEE TABLE

**MATERIALS**  
powder coated aluminium  
untreated teak

**DIMENSIONS**  
123 x 55 cm

**COLOURS**



BLACK ALUMINIUM  
UNTREATED TEAK      WHITE ALUMINIUM  
UNTREATED TEAK

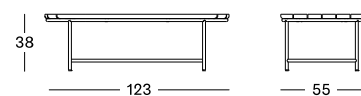



# EDGARD LENA GIPSY

Woven wicker furniture 100% fit for outdoor use all year round



DINING CHAIR - BAR STOOL - LOUNGE CHAIR - COCOON









LEFT PAGE: GIPSY DINING CHAIR AND WICKED DINING TABLE  
RIGHT PAGE: GIPSY LOUNGE CHAIR AND IVO COFFEE TABLE







EDGARD DINING CHAIR black  
MATTEO DINING TABLE AND LIGHT MY TABLE





LENA DINING CHAIR old lace



### EDGARD DINING CHAIR TEAK BASE

**MATERIALS**

aluminium and polyethylene wicker seat  
teak base

**CUSHIONS**

2 cm polyether foam

**COLOURS**



UNTREATED TEAK  
OLD LACE



UNTREATED TEAK  
MOCCA



UNTREATED TEAK  
BLACK

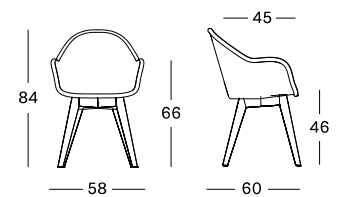

### EDGARD DINING CHAIR STEEL A BASE

**MATERIALS**

aluminium and polyethylene wicker seat  
black epoxy coated steel base

**CUSHIONS**

2 cm polyether foam

**COLOURS**



BLACK  
OLD LACE



BLACK  
MOCCA



BLACK  
BLACK

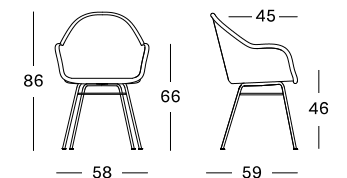

### LENA DINING CHAIR TEAK BASE

**MATERIALS**

aluminium and polyethylene wicker seat  
teak base

**COLOURS**



UNTREATED TEAK  
OLD LACE



UNTREATED TEAK  
MOCCA



UNTREATED TEAK  
BLACK

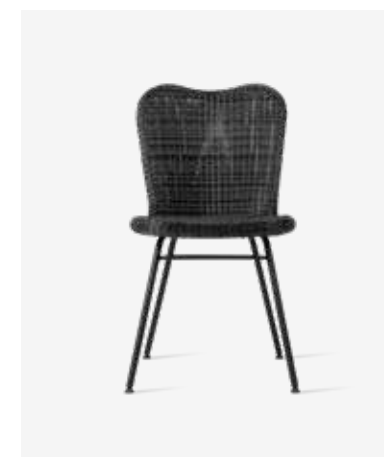
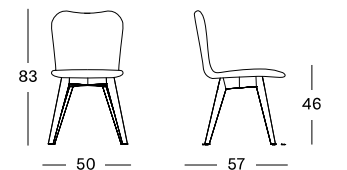

### LENA DINING CHAIR STEEL A BASE

**MATERIALS**

aluminium and polyethylene wicker seat  
black epoxy coated steel base

**COLOURS**



BLACK  
OLD LACE



BLACK  
MOCCA

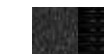

BLACK  
BLACK

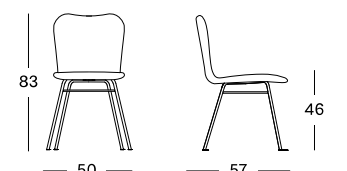





### MATTEO DINING TABLE

#### MATERIALS

powder coated aluminium legs  
untreated teak top

#### DIMENSIONS

215 x 100 cm  
285 x 100 cm

#### COLOURS



BLACK ALUMINIUM  
UNTREATED TEAK    DUNE WHITE ALUMINIUM  
UNTREATED TEAK

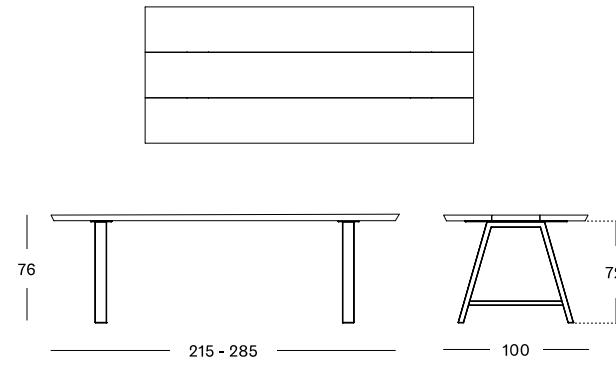

### GIPSY DINING CHAIR

#### MATERIALS

aluminium and polyethylene wicker seat  
epoxy and powder coated steel base

#### CUSHIONS

2 cm polyether foam

#### COLOUR



BLACK STEEL  
BLACK WICKER

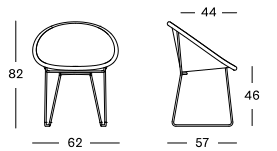

### MATTEO BENCH

#### MATERIALS

powder coated aluminium legs  
untreated teak seat

#### DIMENSIONS

195 x 40 cm  
265 x 40 cm

#### COLOURS



BLACK ALUMINIUM  
UNTREATED TEAK    DUNE WHITE ALUMINIUM  
UNTREATED TEAK

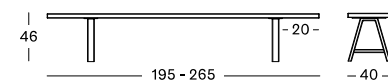

### GIPSY COCOON

#### MATERIALS

aluminium and polyethylene wicker seat  
epoxy and black powder coated steel base

#### CUSHIONS

8 cm quick dry foam

#### COLOUR



BLACK STEEL  
BLACK WICKER

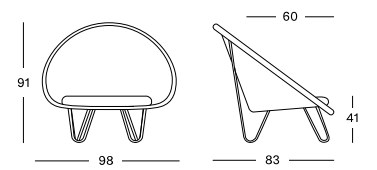

### EDGARD BAR STOOL TEAK BASE

#### MATERIALS

aluminium and polyethylene wicker seat  
teak base

#### COLOURS



UNTREATED TEAK  
OLD LACE    UNTREATED TEAK  
MOCCA    UNTREATED TEAK  
BLACK

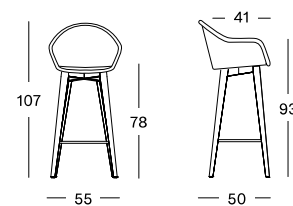

### GIPSY LOUNGE

#### MATERIALS

aluminium and polyethylene wicker seat  
epoxy and black powder coated steel base

#### CUSHIONS

seat 12 cm quick dry foam  
back 1 x (60x60) and 2x (40x40)

#### COLOUR



BLACK STEEL  
BLACK WICKER

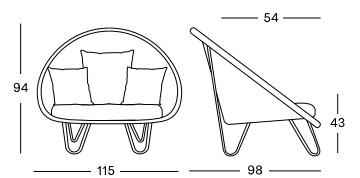

### EDGARD BAR STOOL STEEL BASE

#### MATERIALS

aluminium and polyethylene wicker seat  
black epoxy coated steel base

#### COLOURS



BLACK  
OLD LACE    BLACK  
MOCCA    BLACK  
BLACK

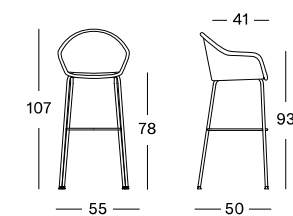





**IVO SIDE TABLE DIA 44**

**MATERIALS**

powder coated aluminium  
HDPE wicker  
hpl

**DIMENSIONS**

45 cm H x Ø 44 cm

**COLOUR**



BLACK WICKER  
BLACK HPL

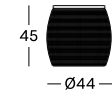

**IVO COFFEE TABLE DIA 77**

**MATERIALS**

powder coated aluminium  
HDPE wicker  
hpl

**DIMENSIONS**

37 cm H x Ø 77 cm

**COLOUR**



BLACK WICKER  
BLACK HPL

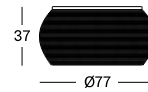

**IVO COFFEE TABLE DIA 93**

**MATERIALS**

powder coated aluminium  
HDPE wicker  
hpl

**DIMENSIONS**

37 cm H x Ø 93 cm

**COLOUR**



BLACK WICKER  
BLACK HPL

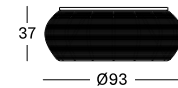



# LUCY

Lucy will inject your terrace and garden with charm and comfort. The soft, flowing round shapes of these chairs invite you to relax in the sun.



LAZY ARMCHAIR - LOUNGE CHAIR - FOOTREST - SIDE TABLE - MODULAR SOFA - DINING CHAIR - SUNLOUNGER





LEFT PAGE: LUCY DINING ARMCHAIR off white  
RIGHT PAGE: LUCY LOUNGE CHAIR off white











### LUCY DINING CHAIR

**MATERIALS**  
powder coated aluminium  
polyethylene fibre

**CUSHION**  
seat 2 cm polyether foam

**COLOUR**



OFF WHITE

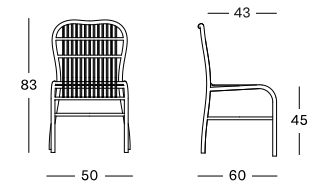

### LUCY DINING ARMCHAIR

**MATERIALS**  
powder coated aluminium  
polyethylene fibre

**CUSHION**  
seat 2 cm polyether foam

**COLOUR**



OFF WHITE

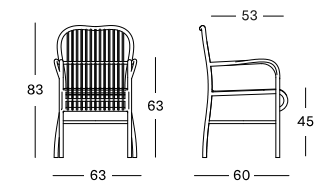

### LUCY SUNLOUNGER

**MATERIALS**  
powder coated aluminium  
polyethylene fibre

**CUSHION**  
seat 3 cm polyether foam

**COLOUR**



OFF WHITE

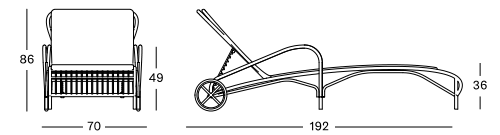





### LUCY LAZY ARMCHAIR

**MATERIALS**  
powder coated aluminium  
polyethylene fibre

**CUSHION**  
seat 2 cm polyether foam

**COLOUR**



OFF WHITE

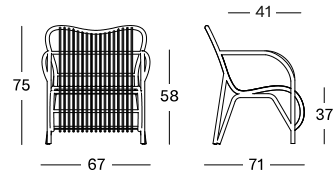

### LUCY MODULAR CORNER

**MATERIALS**  
powder coated aluminium  
polyethylene fibre

**CUSHIONS**  
seat 12 cm quick dry foam  
back polyester fibre

**COLOUR**



OFF WHITE

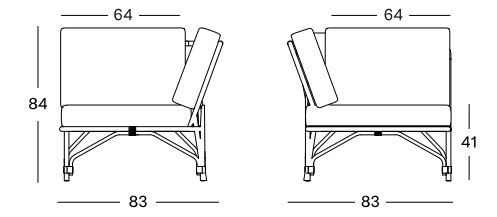

### LUCY LOUNGE CHAIR

**MATERIALS**  
powder coated aluminium  
polyethylene fibre

**COLOUR**



OFF WHITE

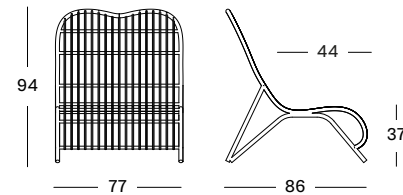

### LUCY MODULAR CENTER

**MATERIALS**  
powder coated aluminium  
polyethylene fibre

**CUSHIONS**  
seat 12 cm quick dry foam  
back polyester fibre

**COLOUR**



OFF WHITE

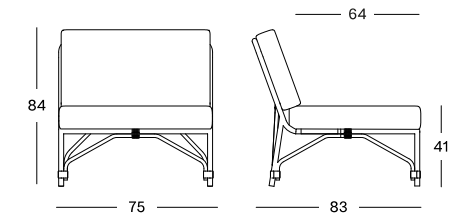

### LUCY FOOTREST

**MATERIALS**  
powder coated aluminium  
polyethylene fibre

**COLOUR**



OFF WHITE

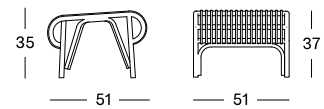

### LUCY OTTOMAN

**MATERIALS**  
powder coated aluminium  
polyethylene fibre

**CUSHIONS**  
seat 12 cm quick dry foam

**COLOUR**



OFF WHITE

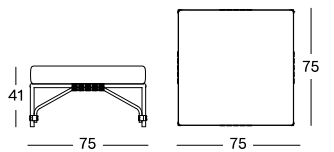

### LUCY SIDE TABLE

**MATERIALS**  
powder coated aluminium  
polyethylene fibre  
glass

**DIMENSIONS**  
46 x 46 cm

**COLOUR**



OFF WHITE

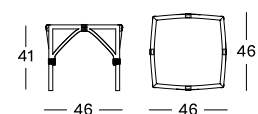

### LUCY MODULAR COFFEE TABLE

**MATERIALS**  
powder coated aluminium  
polyethylene fibre  
glass

**DIMENSIONS**  
75 x 75 cm

**COLOUR**



OFF WHITE

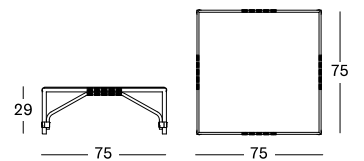



# SAFI

Safi stands for timeless outdoor pleasure. The handwoven furniture gives your terrace a royal comfort and adapts naturally to each environment.



LOUNGE CHAIR - LOUNGE SOFA - SIDE TABLE - SUNLOUNGER - DINING CHAIR - DINING TABLE





SAFI LOUNGE SOFA 2S, LOUNGE SOFA 3S AND LOUNGE CHAIR old lace





LEFT PAGE: SAFI SUNLOUNGER old lace  
RIGHT PAGE: SAFI DINING CHAIR AND DINING TABLE old lace







### SAFI DINING CHAIR

**MATERIALS**  
powder coated aluminium frame  
polyethylene fibre

**CUSHION**  
4 cm polyether foam

**COLOUR**



OLD LACE

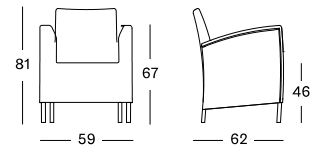

### SAFI LOUNGE CHAIR

**MATERIALS**  
powder coated aluminium frame  
polyethylene fibre

**CUSHION**  
seat 12 cm quick dry foam  
back polyester fibre

**COLOUR**



OLD LACE

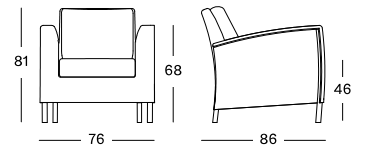

### SAFI DINING TABLE DIA 120

**MATERIALS**  
powder coated aluminium frame  
polyethylene fibre  
glass (optional)

**DIMENSIONS**  
Ø 120 cm

**COLOUR**



OLD LACE

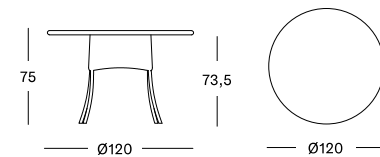

### SAFI LOUNGE SOFA 2S

**MATERIALS**  
powder coated aluminium frame  
polyethylene fibre

**CUSHION**  
seat 12 cm quick dry foam  
back polyester fibre

**COLOUR**



OLD LACE

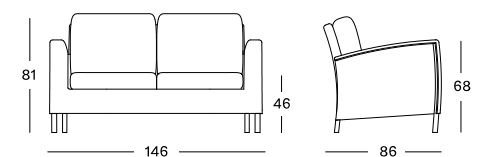

### SAFI SUNLOUNGER

**MATERIALS**  
powder coated aluminium frame  
polyethylene fibre

**CUSHION**  
3 cm polyether foam

**COLOUR**



OLD LACE

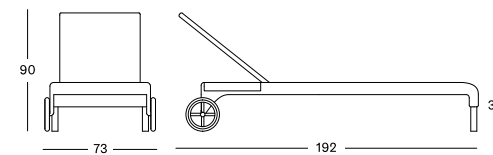

### SAFI LOUNGE SOFA 3S

**MATERIALS**  
powder coated aluminium frame  
polyethylene fibre

**CUSHION**  
seat 12 cm quick dry foam  
back polyester fibre

**COLOUR**



OLD LACE

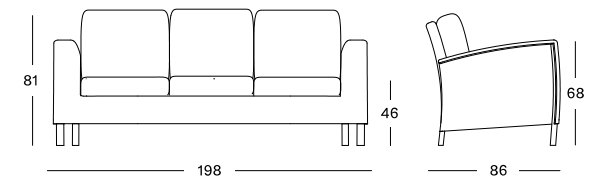

### SAFI SUNLOUNGER WITH ARMS

**MATERIALS**  
powder coated aluminium frame  
polyethylene fibre

**CUSHION**  
3 cm polyether foam

**COLOUR**



OLD LACE

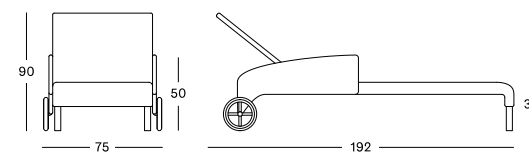

### SAFI SIDE TABLE

**MATERIALS**  
powder coated aluminium frame  
polyethylene fibre  
glass (optional)

**DIMENSIONS**  
60 x 60 cm

**COLOUR**



OLD LACE

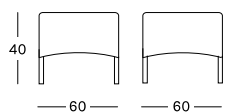





KENZO DINING CHAIR old lace



### MIA DINING CHAIR

**MATERIALS**

aluminium frame  
polyethylene wicker

**CUSHIONS**

4 cm polyether foam

**COLOURS**



OLD LACE

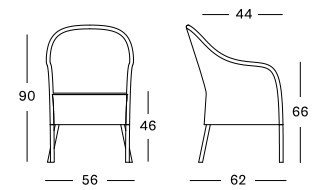

### KENZO DINING CHAIR

**MATERIALS**

aluminium frame  
polyethylene wicker

**CUSHIONS**

4 cm polyether foam

**COLOURS**



OLD LACE

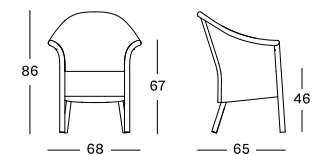



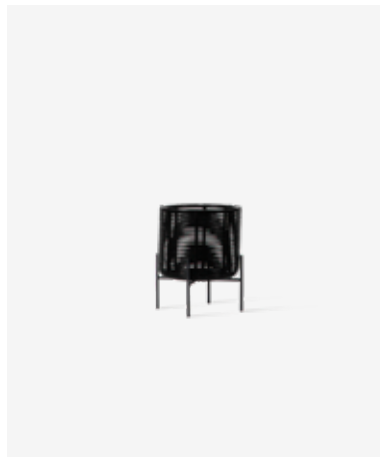

### IVO PLANT STAND SMALL

#### MATERIALS

powder coated aluminium  
HDPE wicker  
plastic saucer

#### DIMENSIONS

36 cm H x Ø 29 cm

#### COLOUR



BLACK ALUMINIUM  
BLACK WICKER

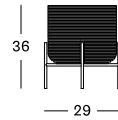

### IVO PLANT STAND MEDIUM

#### MATERIALS

powder coated aluminium  
HDPE wicker  
plastic saucer

#### DIMENSIONS

45 cm H x Ø 40 cm

#### COLOUR



BLACK ALUMINIUM  
BLACK WICKER

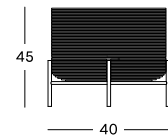

### IVO PLANT STAND LARGE

#### MATERIALS

powder coated aluminium  
HDPE wicker  
plastic saucer

#### DIMENSIONS

65 cm H x Ø 29 cm

#### COLOUR



BLACK ALUMINIUM  
BLACK WICKER

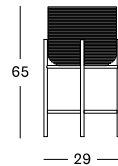



# OUTDOOR LLOYD LOOM

Lloyd Loom weave is a unique material made of steel and paper. The strong and flexible material is coated with latex for outdoor use.



LOUNGE CHAIR - LOUNGE SOFA - FOOTREST - SIDE TABLE - COFFEE TABLE - SUNLOUNGER - DINING CHAIR - DINING TABLE













LEFT PAGE: DOVILE DINING CHAIR pure white  
RIGHT PAGE: MONTE CARLO DINING CHAIR AND AVIGNON SIDE TABLE pure white





### DOVILE DINING CHAIR

**MATERIALS**  
powder coated aluminium frame  
outdoor treated Lloyd Loom weave

**CUSHION**  
seat 4 cm polyether foam

**COLOURS**  
see page 167

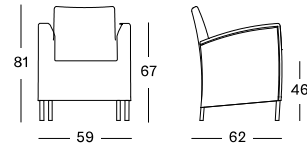

### NIMES TABLE DIA 110 / 130

**MATERIALS**  
powder coated aluminium frame  
outdoor treated Lloyd Loom weave  
glass (optional)

**DIMENSIONS**  
Ø 110 cm  
Ø 130 cm

**COLOURS**  
see page 167

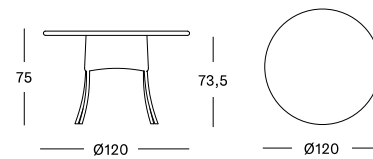

### DOVILE FOOTREST

**MATERIALS**  
powder coated aluminium frame  
outdoor treated Lloyd Loom weave

**CUSHIONS**  
seat 11 cm polyether foam

**COLOURS**  
see page 167

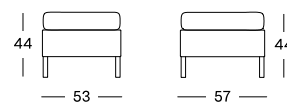

### DOVILE SIDE TABLE

**MATERIALS**  
powder coated aluminium  
outdoor treated Lloyd Loom weave  
glass (optional)

**DIMENSIONS**  
60 x 60 cm

**LOOM COLOURS**  
see page 167

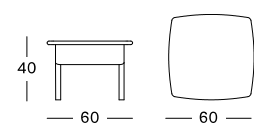

### DOVILE LOUNGE CHAIR

**MATERIALS**  
powder coated aluminium frame  
outdoor treated Lloyd Loom weave

**CUSHIONS**  
seat 12 cm high resilience foam  
back polyester fibre

**COLOURS**  
see page 167

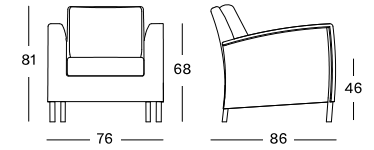

### DOVILE LOUNGE SOFA 2S

**MATERIALS**  
powder coated aluminium frame  
outdoor treated Lloyd Loom weave

**CUSHIONS**  
seat 12 cm high resilience foam  
back polyester fibre

**COLOURS**  
see page 167

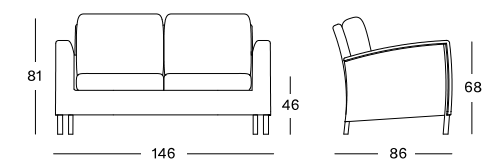

### DOVILE LOUNGE SOFA 3S

**MATERIALS**  
powder coated aluminium frame  
outdoor treated Lloyd Loom weave

**CUSHIONS**  
seat 12 cm high resilience foam  
back polyester fibre

**COLOURS**  
see page 167

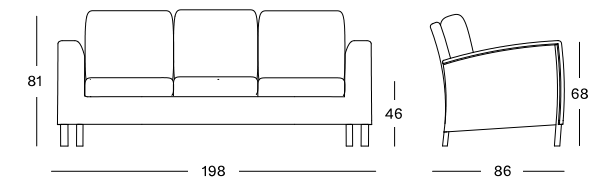

### DOVILE COFFEE TABLE

**MATERIALS**  
powder coated aluminium frame  
outdoor treated Lloyd Loom weave  
glass (optional)

**DIMENSIONS**  
60 x 106 cm

**LOOM COLOURS**  
see page 167

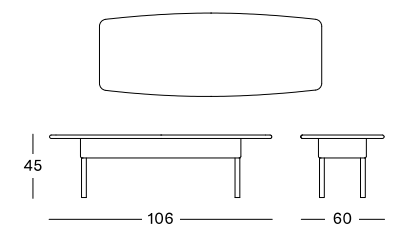





### DOVILE SUNLOUNGER WITH ARMS

**MATERIALS**  
powder coated aluminium frame  
outdoor treated Lloyd Loom weave

**CUSHION**  
seat 3 cm polyether foam

**LOOM COLOURS**  
see page 167

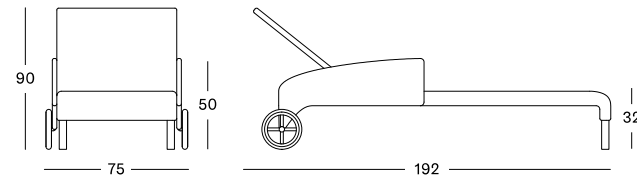

### NICE DINING CHAIR

**MATERIALS**  
powder coated aluminium frame  
outdoor treated Lloyd Loom weave

**CUSHION**  
seat 4 cm polyether foam

**LOOM COLOURS**  
see page 167

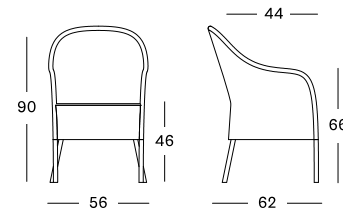

### MONTE CARLO DINING CHAIR

**MATERIALS**  
powder coated aluminium frame  
outdoor treated Lloyd Loom weave

**CUSHION**  
seat 4 cm polyether foam

**LOOM COLOURS**  
see page 167

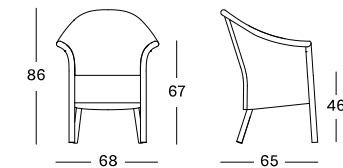

### AVIGNON SIDE TABLE

**MATERIALS**  
powder coated aluminium frame  
outdoor treated Lloyd Loom weave  
glass (optional)

**DIMENSIONS**  
60 cm H x Ø 60 cm

**LOOM COLOURS**  
see page 167

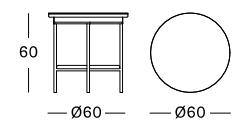

## LLOYD LOOM COLOURS

### SOLID COLOURS

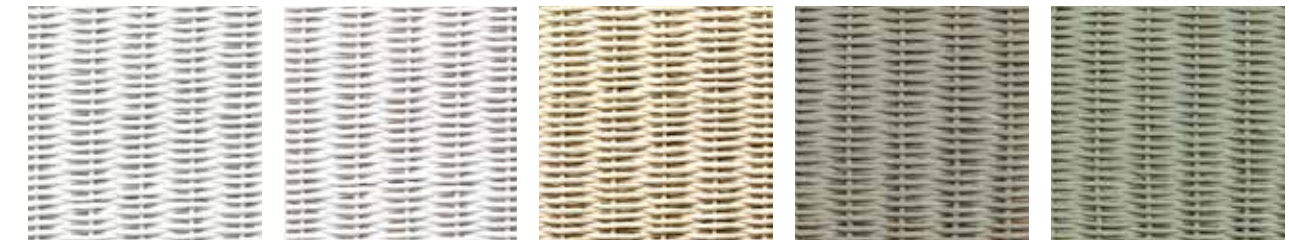

PURE WHITE  
P024

SNOW  
P020

BROKEN WHITE  
P026

PEBBLE  
P025

DUSTY GREEN  
P050

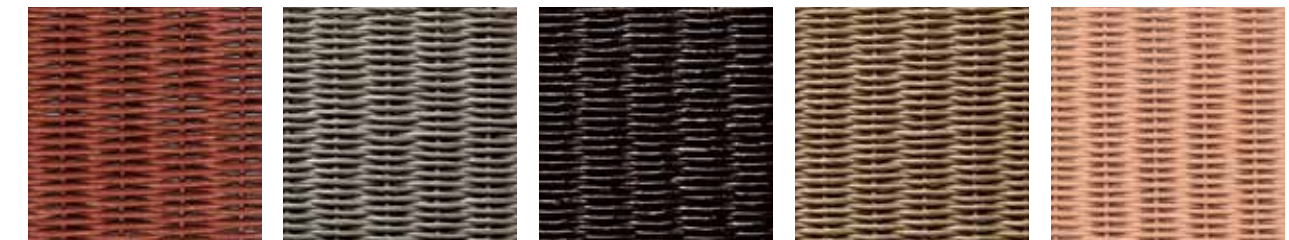

TERRACOTTA  
P035

QUARTZ GREY  
P086

BLACK  
P080

TAUPE  
P084

DUSTY CORAL  
P034

### METALLIC FINISH

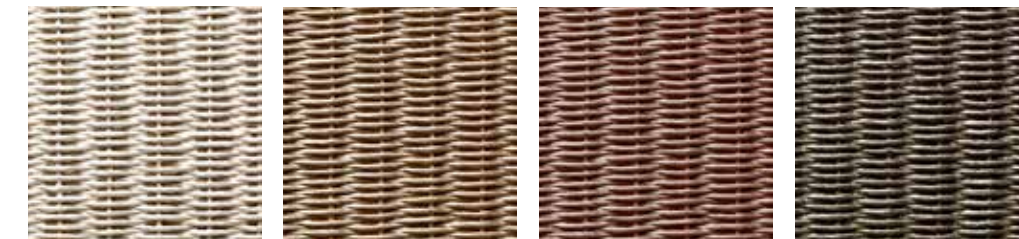

SPARKLE  
P033

NACRÉ  
P023

COPPER  
P079

OYSTER  
P036

All colours shown here are as close to the actual colours as the printing process allows.  
Swatches can be supplied on request.





**DECO CUSHION**

**DIMENSION**  
60 x 60 cm

**FABRICS**  
see page 174 - 175



**DECO CUSHION**

**DIMENSION**  
50 x 50 cm

**FABRICS**  
see page 174 - 175



**DECO CUSHION**

**DIMENSION**  
45 x 50 cm

**FABRICS**  
see page 174 - 175



**DECO CUSHION**

**DIMENSION**  
40 x 40 cm

**FABRICS**  
see page 174 - 175



**DECO CUSHION**

**DIMENSION**  
35 x 50 cm

**FABRICS**  
see page 174 - 175

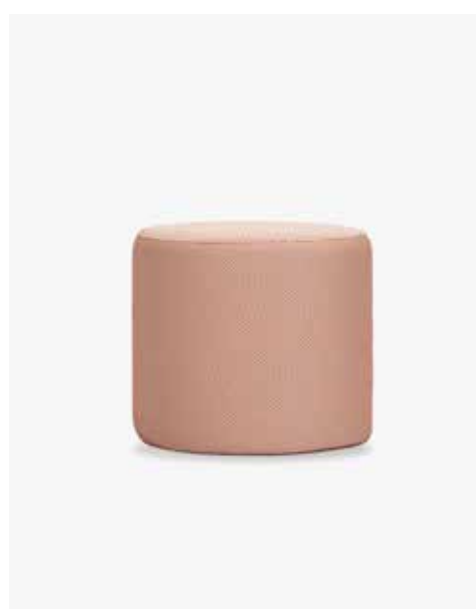

**OLAF DIA 50**

**MATERIALS**  
breathable polyester  
polystyrene beads

**DIMENSIONS**  
40 cm H x Ø 50 cm

**COLOURS**  
quick ship or com fabric

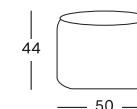

**OLAF DIA 80**

**MATERIALS**  
breathable polyester  
polystyrene beads

**DIMENSIONS**  
40 cm H x Ø 80 cm

**COLOURS**  
Quick ship or com fabric

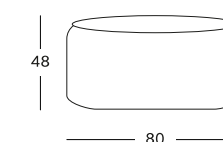

**OTTO**

**MATERIALS**  
breathable polyester  
polystyrene beads

**DIMENSIONS**  
42 cm H x Ø 52 cm

**COLOURS**

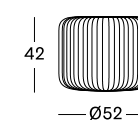



# TECHNICAL INFORMATION



**TEAK**

Teak is a tropical hardwood which is known for its strength and durability. Our teak furniture is delivered untreated and will develop a beautiful silvery grey patina. Clean your table once a year with warm soapy water to discourage moss. If you wish to protect your furniture against stains, we recommend treating teak furniture with a teak sealant. As teak is a natural product, small cracks may develop over time.

**ALUMINIUM**

Aluminium is a light-weight material which is mainly used as an alternative for steel. Aluminium has a self-protective layer, which prevents corrosion and makes this material very suitable for outdoor applications. Our aluminium furniture is powder coated, which enables us to offer a wide variety of colours. On top of that, it is super easy to maintain. A quick wash with a non-foaming mild detergent every now and then is all it needs!

**SYNTHETIC WEAVE**

For our all-weather outdoor collection, we use multiple synthetic materials, including polyethylene, polypropylene, and HDPE wicker. All our synthetic materials are specifically designed to withstand any weather conditions, are UV-resistant, and can be left outside all year long. We recommend giving them a quick wash when dirty or every three months with a non-foaming mild detergent.

**100% SOLUTION DYED ACRYLIC**

- may be machine-washed at 40°C
- may be tumble dried
- may be ironed, ironing temperature should not be higher than 110°C
- the fabric may be treated with bleach
- may be dry cleaned

**ACRYLIC ROPE**

- may be machine-washed at 40°C
- may be tumble dried
- may be ironed, ironing temperature should not be higher than 110°C
- the fabric may be treated with bleach
- may be dry cleaned

**POLYPROPYLENE ROPE**

- may be machine-washed at 40°C
- may be tumble dried
- may be ironed, ironing temperature should not be higher than 110°C
- the fabric may not be treated with bleach
- do not dry clean



**CERAMIC**

Ceramic requires little to no maintenance, yet offers maximum resistance. The material preserves the natural look of stone and offers top of the chart convenience. Ceramic is scratchproof, UV-resistant, stainproof, and resistant to fire and high temperatures. Use pure water or a cleaning solution without soap for ceramic surfaces to clean the table. Please do not use soap.

**OUTDOOR LOOM**

Lloyd Loom weave is made from twisted Kraft paper on the one hand, and Kraft paper spun around a steel wire on the other hand. In order to be able to use Lloyd Loom for outside furniture as well, a specific technique was developed to make the material waterproof. Our outdoor Lloyd Loom models can thus simply be left outside, although we recommend storing them inside during cold or rainy periods.

**CUSHIONS**

From snuggling between soft pillows to enjoying a dinner party on a lovely dining chair with seat cushion. Comfortable cushions take your seating experience to the next level.

Vincent Sheppard uses high-quality materials and relies on advanced textile technologies to create its cushions. Our fabrics are water-repellent, breathable, and UV-proof. The cushion's cores consist of outdoor foam, enabling you to leave them outdoors during any weather condition. Still, we recommend storing your cushions for the winter or when not in use for long periods.

**100% POLYOLEFIN**

- may be machine-washed at 40°C with extra care
- do not tumble dry
- may not be ironed
- may be treated with bleach
- do not dry clean

**MIX OF MATERIALS**

- may be machine-washed at 40°C with extra care
- do not tumble dry
- do not iron
- do not bleach
- do not dry clean

**OUTDOOR HPL**

HPL or high-pressure laminate is a very sturdy material which consists of different layers which are pressed together under a high temperature. As a result, the material is very durable and UV-resistant. HPL is used for our table tops and can be used indoors as well as outdoors. The table tops do not require any maintenance except for a quick wash every now and then.

**STEEL**

Steel is mainly used for the legs and frames of our furniture pieces. For the outdoor pieces, the steel is always galvanized and powder coated to make sure it is protected from all weather influences.

**RUGS**

Vincent Sheppard outdoor rugs are made of polyester fibres. The high-performance rugs are dirt and water-repellent, and are thus easy to maintain. Use a high-pressure water hose to clean spots and blot dry afterwards.

Nearly all our cushion covers are removable which makes them look brand-new after a wash. As every fabric has its own characteristics, different washing instructions apply.



**PROTECTIVE COVERS**

In order to protect your furniture and keep maintenance minimal, we have developed special protective covers.

The covers are made of 100% polyurethane and have welded, not stitched seams. Consequently, the covers are 100% waterproof.



**CAT. B CUSHION FABRICS**

Item codes starting with CB or QB



**CANVAS S0606**  
100% SOLUTION DYED ACRYLIC



**LIN S1212**  
100% SOLUTION DYED ACRYLIC

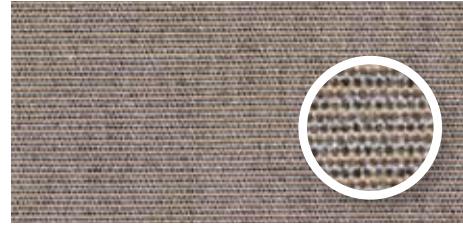

**LONDON STONE S0808**  
100% SOLUTION DYED ACRYLIC

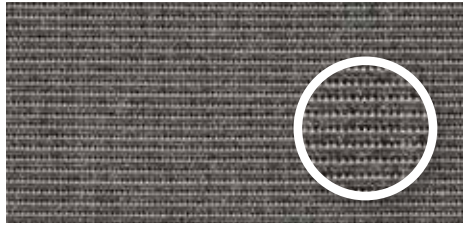

**DARK SMOKE S0909**  
100% SOLUTION DYED ACRYLIC

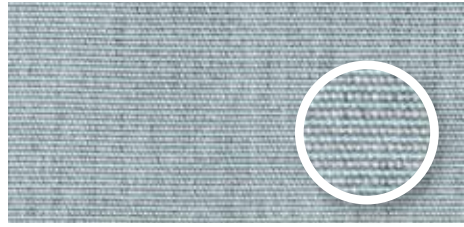

**MINERAL BLUE S1010**  
100% SOLUTION DYED ACRYLIC



**BLUSH S2929**  
100% SOLUTION DYED ACRYLIC



**BLACK S1515**  
100% SOLUTION DYED ACRYLIC

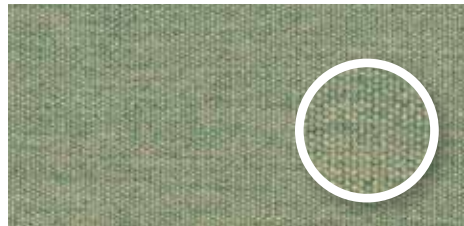

**OLIVE GREEN S2727**  
100% SOLUTION DYED ACRYLIC

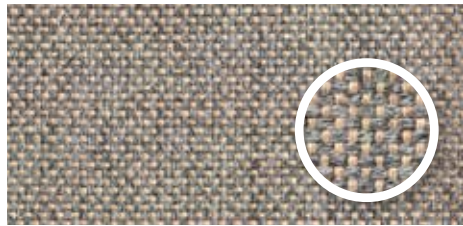

**CARBON BEIGE S2828**  
100% SOLUTION DYED ACRYLIC

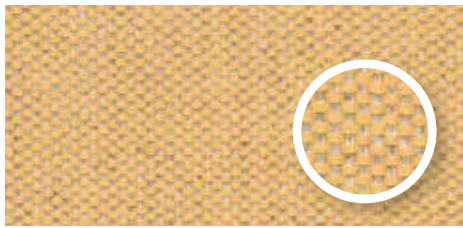

**AMBER S3030**  
100% SOLUTION DYED ACRYLIC

**CAT. C CUSHION FABRICS**

Item codes starting with CC or QC

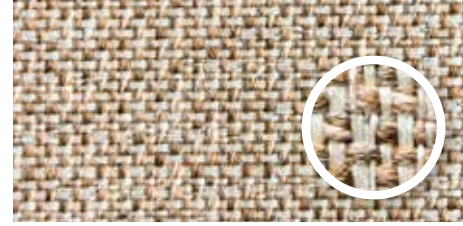

**SAVANE COCONUT S2222**  
100% SOLUTION DYED ACRYLIC

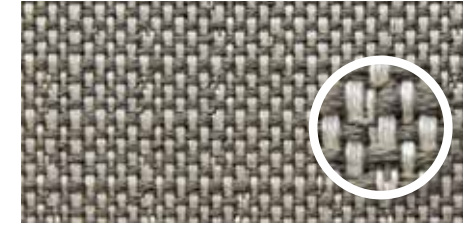

**ZINC S2121**  
100% SOLUTION DYED ACRYLIC



**SPICE P0202**  
100% POLYOLEFIN

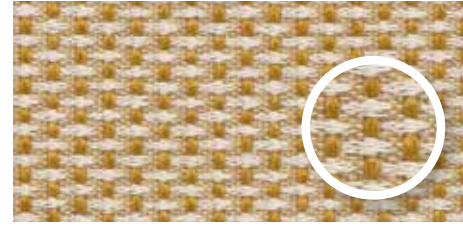

**MUSTARD P0505**  
57% POLYOLEFIN / 43% POLYESTER

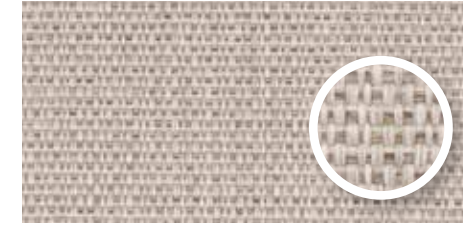

**ALMOND P0303**  
100% POLYPROPYLENE

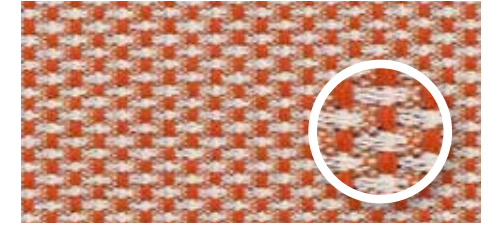

**CORAL P0404**  
57% POLYOLEFIN / 43% POLYESTER

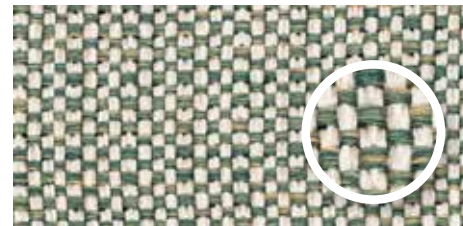

**FIG GREEN M0303**  
100% POLYPROPYLENE

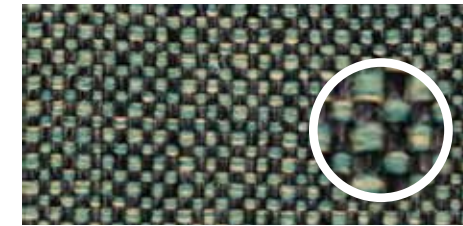

**PINE GREEN M0202**  
100% POLYPROPYLENE

**CAT. G CUSHION FABRICS**

Item codes starting with CG or QG



**LIME WHITE BOUCLÉ M0101**  
100% POLYPROPYLENE

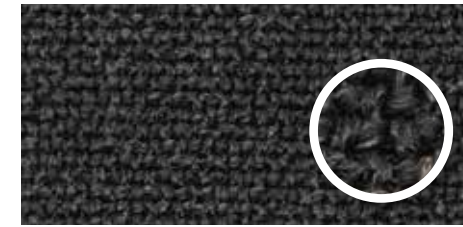

**BLACK BOUCLÉ M0404**  
100% POLYPROPYLENE

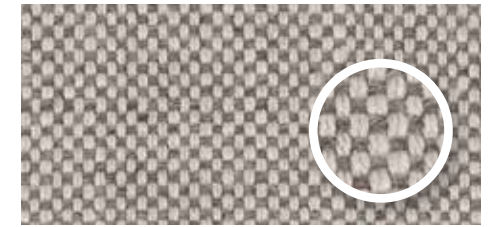

**STONE T0202**  
100% SOLUTION DYED ACRYLIC

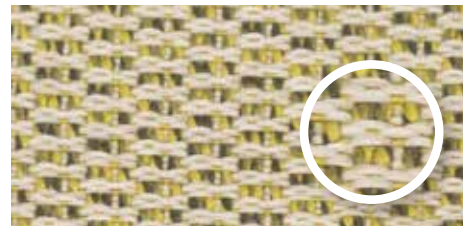

**KIWI P0707**  
100% POLYPROPYLENE

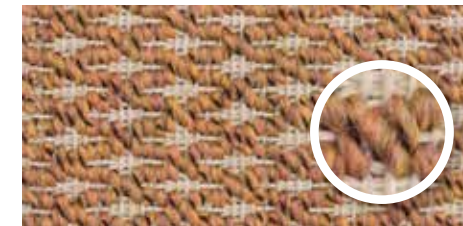

**SIENNA M0505**  
100% POLYPROPYLENE



# PRODUCT OVERVIEW

DINING CHAIRS - BAR STOOLS - LOUNGE CHAIRS - SOFAS - FOOTRESTS - POUFFES  
SUNLOUNGERS - TABLES - BENCHES - COFFEE TABLES - SIDE TABLES - ACCESSORIES





**CLEO DINING CHAIR**  
P 53



**REMI DINING CHAIR**  
P 63



**FREYA DINING ARMCHAIR**  
P 62



**KODO DINING CHAIR**  
P 32



**EDGARD DINING CHAIR**  
P 129



**FRIDA DINING CHAIR**  
P 11



**GIPSY DINING CHAIR**  
P 131



**LEO DINING CHAIR**  
P 73



**LENA DINING CHAIR STEEL A BASE**  
P 129



**LENA DINING CHAIR TEAK BASE**  
P 129



**ROXANNE DINING CHAIR**  
P 109



**ROXY DINING CHAIR**  
P 109





**LOOP DINING CHAIR**  
P 91



**WICKED DINING CHAIR**  
P 118



**MIA DINING CHAIR SYNTHETIC**  
P 153



**KENZO DINING CHAIR SYNTHETIC**  
P 153



**SAFI DINING CHAIR SYNTHETIC**  
P 150



**MONA DINING CHAIR**  
P 63



**DAVID DINING ARMCHAIR**  
P 82



**NICE DINING CHAIR LLOYD LOOM**  
P 166



**DOVILE DINING CHAIR LLOYD LOOM**  
P 164



**MONTE CARLO DINING CHAIR LLOYD LOOM**  
P 166



**LUCY DINING CHAIR**  
P 141



**LUCY DINING ARMCHAIR**  
P 141



**EDGARD BAR STOOL TEAK BASE**  
P 130



**EDGARD BAR STOOL STEEL BASE**  
P 130





**ODA LOUNGE CHAIR**  
P 18



**CLEO LOUNGE CHAIR**  
P 53



**LENTO LOUNGE CHAIR**  
P 43



**FRIDA LOUNGE CHAIR**  
P 11



**ROY LAZY CHAIR**  
P 109



**ROY COCOON**  
P 109



**DAVID LOUNGE CHAIR**  
P 83



**KODO LOUNGE CHAIR**  
P 32



**LEO LOUNGE CHAIR**  
P 71



**LOOP LOUNGE CHAIR**  
P 91



**KODO ROCKING CHAIR**  
P 32



**KODO COCOON**  
P 32





**GIPSY LOUNGE & GIPSY COCOON**  
P 131



**WICKED LOUNGE CHAIR**  
P 119



**OLAF POUFFE**  
P 169



**OTTO POUFFE (AVAILABLE IN 4 COLOURS)**  
P 169



**DOVILE LOUNGE CHAIR LLOYD LOOM**  
P 165



**SAFI LOUNGE CHAIR SYNTHETIC**  
P 151



**KODO FOOTREST**  
P 33



**LOOP FOOTREST**  
P 90



**DOVILE FOOTREST LLOYD LOOM**  
P 164



**LUCY FOOTREST**  
P 142



**LUCY LAZY ARMCHAIR**  
P 142



**LUCY LOUNGE**  
P 142





**DAVID SUNLOUNGER**  
P 82



**KODO SUNLOUNGER**  
P 37



**LOOP SUNLOUNGER**  
P 91



**KODO DEEP SOFA**  
P 36



**CLEO SOFA**  
P 53



**LUCY SUNLOUNGER**  
P 141



**SAFI SUNLOUNGER SYNTHETIC**  
P 150



**SAFI SUNLOUNGER WITH ARMS SYNTHETIC**  
P 150



**KODO LOUNGE SOFA**  
P 33



**KODO DAYBED**  
P 33



**DOVILE SUNLOUNGER WITH ARMS LLOYD LOOM**  
P 166



**DAVID LOUNGE SOFA 2S**  
P 83



**DAVID LOUNGE SOFA 3S**  
P 83





**SAFI LOUNGE SOFA 2S  
SYNTHETIC**  
P 151



**SAFI LOUNGE SOFA 3S  
SYNTHETIC**  
P 151



**ODA LOUNGE SOFA 2.5S**  
P 18



**ODA LOUNGE SOFA 3S**  
P 18



**DOVILE LOUNGE SOFA 2S LLOYD LOOM**  
P 165



**DOVILE LOUNGE SOFA 3S LLOYD LOOM**  
P 165



**LEO LOUNGE SOFA**  
P 71



**LOOP SOFA**  
P 91



**WICKED LOUNGE SOFA 2S**  
P 119



**WICKED LOUNGE SOFA 3S**  
P 119



**LENTO LOUNGE SOFA 2.5S**  
P 43



**LENTO LOUNGE SOFA 3S**  
P 43





**KODO MODULAR SET**  
P 32



**LENTO MODULAR SET**  
P 44



**KODO MODULAR 2 SEATER RIGHT**  
P 34



**KODO MODULAR CORNER**  
P 35



**KODO MODULAR 2 SEATER LEFT**  
P 35



**LENTO MODULAR CORNER LEFT**  
P 44



**LENTO MODULAR CORNER RIGHT**  
P 44



**KODO MODULAR 1 SEATER RIGHT**  
P 34



**KODO MODULAR CENTER**  
P 34



**KODO MODULAR COFFEE TABLE**  
P 36



**KODO MODULAR 1 SEATER LEFT**  
P 35



**LENTO CHAISE LONGUE RIGHT**  
P 45



**LENTO CHAISE LONGUE LEFT**  
P 45



**KODO MODULAR CHAISE LONGUE RIGHT**  
P 34



**KODO MODULAR OTTOMAN**  
P 36



**KODO MODULAR CHAISE LONGUE LEFT**  
P 35



**LENTO MODULAR OTTOMAN**  
P 45



**LENTO MODULAR CONNECTING SIDE TABLE**  
P 44

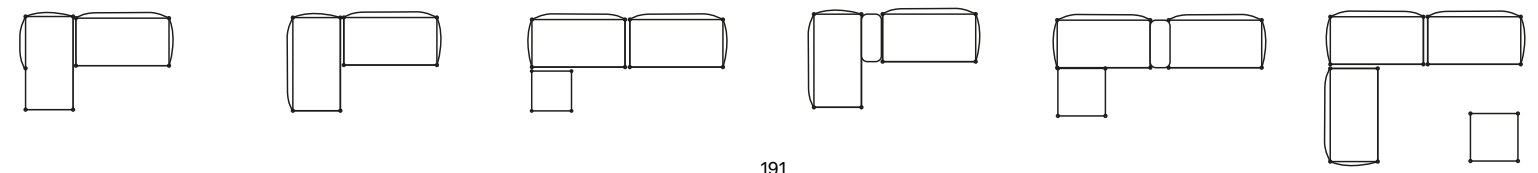
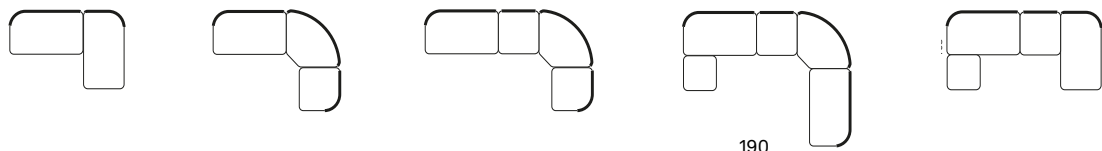





LEO MODULAR SET  
P 70



LUCY MODULAR SET  
P 143



LEO MODULAR CORNER RIGHT  
P 70



LEO MODULAR CORNER LEFT  
P 70



LUCY MODULAR CORNER  
P 143



LUCY MODULAR CENTER  
P 143



LEO MODULAR CENTER  
P 70



LEO MODULAR COFFEE TABLE  
P 70



LEO MODULAR FOOTREST  
P 70



LUCY MODULAR OTTOMAN  
P 143



LUCY MODULAR COFFEE TABLE  
P 143

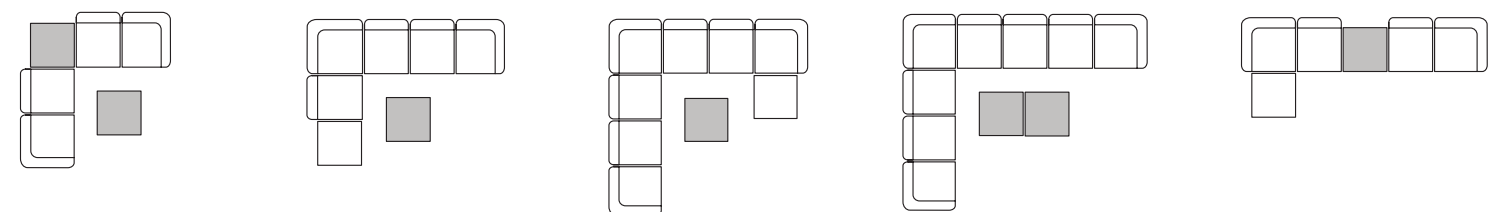
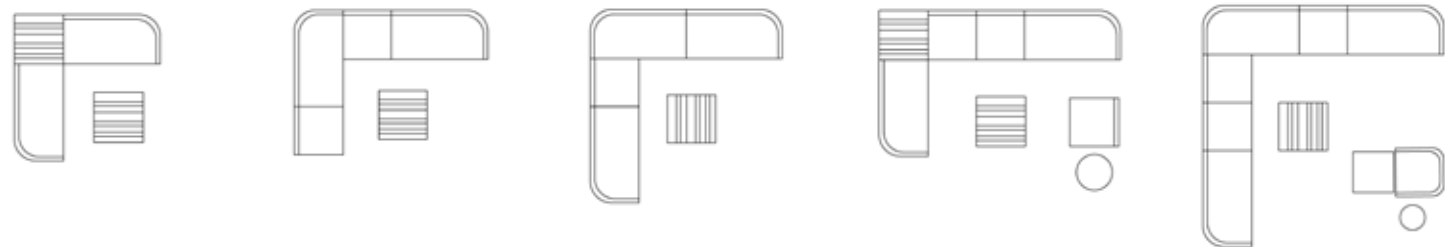





ODA COFFEE AND SIDE TABLES  
P 19



DAVID COFFEE TABLE 129 X 45 & SIDE TABLE 41 X 41  
P 83



DAVID COFFEE TABLE 120 X 120  
P 83



IVO COFFEE AND SIDE TABLE  
P 132



WICKED COFFEE TABLE & SIDE TABLE  
P 118



KODO COFFEE TABLE & SIDE TABLE  
P 37



KODO ROUND COFFEE TABLES & SIDE TABLE  
P 36 | 37



LENTO COFFEE & SIDE TABLES  
P 43



DAVID COFFEE TABLE DIA 68 & SIDE TABLE DIA 40  
P 82



LILO COFFEE AND SIDE TABLES  
P 53





**AVIGNON SIDE TABLE LLOYD LOOM**  
P 71



**DOVILE COFFEE AND SIDE TABLE LLOYD LOOM**  
P 11



**LEO COFFEE & SIDE TABLES**  
P 166



**ANTON TEAK COFFEE AND SIDE TABLES**  
P 164 | 165



**SAFI SIDE TABLE SYNTHETIC**  
P 111



**LUCY SIDE TABLE**  
P 111



**ROZY COFFEE TABLE**  
P 151



**ROZY SIDE TABLE**  
P 142



**LOOP COFFEE TABLE**  
P 90



**LOOP SIDE TABLE**  
P 90





**VOLTA DINING TABLE**  
P 62



**WICKED DINING TABLE**  
P 118



**DAVID DINING TABLE**  
P 82



**KODO DINING TABLE**  
P 33



**SAM DINING TABLE**  
P 11 | 62



**NOA DINING TABLE**  
P 62



**LEO DINING TABLE**  
P 73



**MAX DINING TABLE**  
P 73 | 108



**MATTEO DINING TABLE**  
P 130



**MATTEO BENCH**  
P 130





**RONDA BISTRO TABLE**  
P 108



**SPHERA BISTRO TABLE**  
P 108



**QUADRO BISTRO TABLE**  
P 108



**NIMES DINING TABLE LLOYD LOOM**  
P 164



**SAFI DINING TABLE SYNTHETIC**  
P 150



**TIKA LANTERN**  
P 99



**MORA LAMP**  
P 100



**MAYA LAMP**  
P 96



**IVO PLANT STAND**  
P 154



**LIGHT MY TABLE**  
P 99



**TOUNDRA RUG AND CLIFF RUG**  
P 74



### **Vincent Sheppard showroom**

Doornikserijksweg 193A  
8510 Bellegem - Belgium

On appointment only

### **Vincent Sheppard HQ**

Industriepark 5  
8587 Spiere - Belgium  
+32 56 46 11 11  
info@vincentsheppard.com  
www.vincentsheppard.com





