



Gdaxio



I

Abbiamo ideato un nuovo futuro per vivere lo spazio esterno dominato da sinergia tra:

- Tecnologia
- Ergonomia
- Design
- Innovazione

La sapienza e l'eccellenza italiana artigiana si sono evolute e raffinate attraverso studi accurati e dedicati, tecnologici e di ingegneria, ottenendo risultati STRATOSFERICI: GALAXIA.

EN

We have created a futuristic way of living the outdoors through the synergic combination of:

- Technology
- Ergonomics
- Design
- Innovation

Italian wisdom and artisanal excellence have evolved and been refined through dedicated technological and engineering studies, producing stratospheric results: GALAXIA.

D

Futuristisch innovative Art im Freien zu leben Synergie zwischen:

- Technologie
- Ergonomie
- Design
- Innovation

Die Weisheit und die handwerkliche italienische Exzellenz haben sich weiterentwickelt und verfeinert durch genaue, relevante, technologische und technische Forschungen. Es wurden stratosphärische Ergebnisse erzielt: GALAXIA.

F

Nous avons créé un nouveau produit reposant sur un nouveau concept , la synergie entre :

- Technologie
- Ergonomie
- Conception
- Innovation

L'excellence et le raffinement de l'artisanat italien ont évolué grâce à des études précises et des avancées technologiques de l'ingénierie , permettant d'obtenir des résultats exceptionnels: GALAXIA.

E

Hemos ideado un nuevo futuro para vivir el espacio exterior en sinergia dominado entre:

- Tecnología
- Ergonomía
- Diseño
- Innovación

La sabiduría y la excelencia italiana artesana se han evolucionado y perfeccionado a través de estudios cuidadosos y dedicados, tecnológicos y de ingeniería, obteniendo resultados ESTRATOSFÉRICOS: GALAXIA.

MOTION



I

SISTEMA "MOTION"

Alla base del funzionamento innovativo c'è il Sistema Motion, che evolve il concetto di apertura e chiusura retrattile dell'ombrellone. In questa applicazione innovativa i bracci a forbice azionano direttamente le corone centrali per l'apertura e la chiusura.

EN

SYSTEM "MOTION"

The revolutionary MOTION system allows the umbrella to open and retract in one motion. The innovative scissor arms activate the central crowns which in turn open and close the umbrella.

D

SYSTEM "MOTION"

An der Basis des innovativen Betriebs befindet sich das System Motion, dass das Konzept der Öffnung und Schließung des einziehbaren Schirmes entwickelt. In dieser innovativen Anwendung setzen die scherenfoermige Arme direkt die zentralen Kronen zum Öffnen und Schließen in Bewegung.

F

SYSTEM "MOTION"

A la base de l'opération novatrice il y a le système Motion, qui évolue le concept d'ouverture et de fermeture du parasol rétractable. Dans cette innovante les bras à ciseaux operant directement sur les couronnes centrales pour l'ouverture et la fermeture.

E

SISTEMA "MOTION"

A la base de la operación innovadora está el sistema de movimiento, que evoluciona el concepto de abrir y cerrar el parasol retráctil. En esta aplicación innovadora, los brazos de tijeras conducen directamente las coronas centrales por apertura y cierre.

LIFT ACTION



ERGONOMY DESIGN



I

LIFT ACTION

La principale innovazione è l'applicazione di una molla a gas che agisce sul sistema MOTION assistendo l'apertura e riducendo al minimo lo sforzo in fase di apertura e chiusura dell'ombrellone.

ERGONOMY DESIGN

Non solo tecnologia e funzionalità, ma anche ergonomia nei movimenti. Il design e il gusto italiano incidono sapientemente e rendono questo ombrellone unico in ogni singola linea trasmettendo sensazioni di equilibrio nelle forme.

EN

LIFT ACTION

The main innovation is in the hydraulic gas strut which activates the MOTION system, assisting the mechanical operation and minimizing the effort required to open and close the umbrella.

ERGONOMY DESIGN

Technology, functionality and ergonomic movements. Italian design and style make this umbrella unique, giving a sense of balance to its modern shape.

D

LIFT ACTION

Die wichtigste Neuerung ist die Anwendung einer Gasdruckfeder, die auf das System Motion wirkt und eine mühelose Öffnung und Schließung des Schirmes ermöglicht.

ERGONOMY DESIGN

Nicht nur Technik und Funktionalität, sondern auch Ergonomie der Bewegung. Das Design und das italienische Design haben einen grossen Einfluss und machen aus diesem Schirm ein einzigartiges Produkt. Jede einzelne Linie uebermittelt Gleichgewicht.

F

LIFT ACTION

La principale innovation est la présence d'un ressort à gaz agissant sur le fonctionnement du parasol en facilitant l'ouverture et en réduisant l'effort d'ouverture et de fermeture du parasol.

ERGONOMY DESIGN

Non seulement la technologie et la fonctionnalité, mais aussi l'ergonomie du mouvement. La conception et l'influence de style italien à bon escient et de faire ce parasol unique dans chaque ligne, transmettant des sentiments d'équilibre dans les formes.

E

LIFT ACTION

La principal innovación es la aplicación de un muelle de gas que actúa sobre el sistema de movimiento por ayudar a la apertura y reducir al mínimo el esfuerzo en la apertura y cierre del parasol.

ERGONOMY DESIGN

No sólo la tecnología y funcionalidad, sino también ergonomía de movimiento. El diseño y la influencia de estilo italiano inciden sabiamente y hacen este parasol único en cada línea, transmitiendo la sensación de equilibrio en las formas.





Astro Carbon

I
Ombrellone con innovativo sistema di apertura e chiusura assistito tramite molla a gas. Struttura retrattile che permette apertura e chiusura al di sopra di tavoli e sedie senza dover spostare gli arredi. Connubio tra il futuro e il classico. Adatto per tutti gli ambienti. Telaio in alluminio con effetto antracite metallizzato.

EN
Parasol with innovative opening and closing system assisted by a gas spring. Retractable structure that allows opening and closing above tables and chairs without moving the furniture. Combination between the future and the classic. Suitable for all environments. Aluminum frame with metallic anthracite effect.

D
Sonnenschirm mit innovativem Oeffnungs- und Schliess-System. Mit Unterstuetzung durch eine Gasfeder einziehbares Gestell, das das Oeffnen und Schliessen ueber Tische Und Stuehle ermoeglicht, ohne die Moebel umzuraeumen Kombination zwischen Zukunft und Klassik. Fuer alle Umgebungen geeignet. Aluminiumgestell mit anthrazitgrau Metallic-Effekt.

F
Parasol avec système innovant d'ouverture et de fermeture assisté par ressort à gaz. Structure rétractable qui permet d'ouvrir et de fermerle parasol au-dessus des tables et des chaises sans avoir à déplacer le mobilier. Une combinaison du futur et du classique. Convient à tous les environnements. Cadre en aluminium avec effet anthracite métallise.

E
Parasol con el nuevo sistema de apertura y cierre mediante pistón de gas. Estructura retráctil que permite abrir y cerrar el parasol por encima de las sillas y las mesas sin necesidad de apartar el mobiliario. Fusión entre el futuro y el pasado. Adecuado para todos los ambientes. Estructura de aluminio con efecto antracita metalizado.

NL
Parasol met innovatief openings- en sluitsysteem, ondersteund door een gasveer. Intrekbaar naar de mast met systeem dat openen en sluiten boven tafels en stoelen mogelijk maakt zonder het meubilair te verplaatsen. Combinatie tussen de toekomst en de klassieker. Geschikt voor alle locaties. Aluminium frame met antraciet metallic effect.

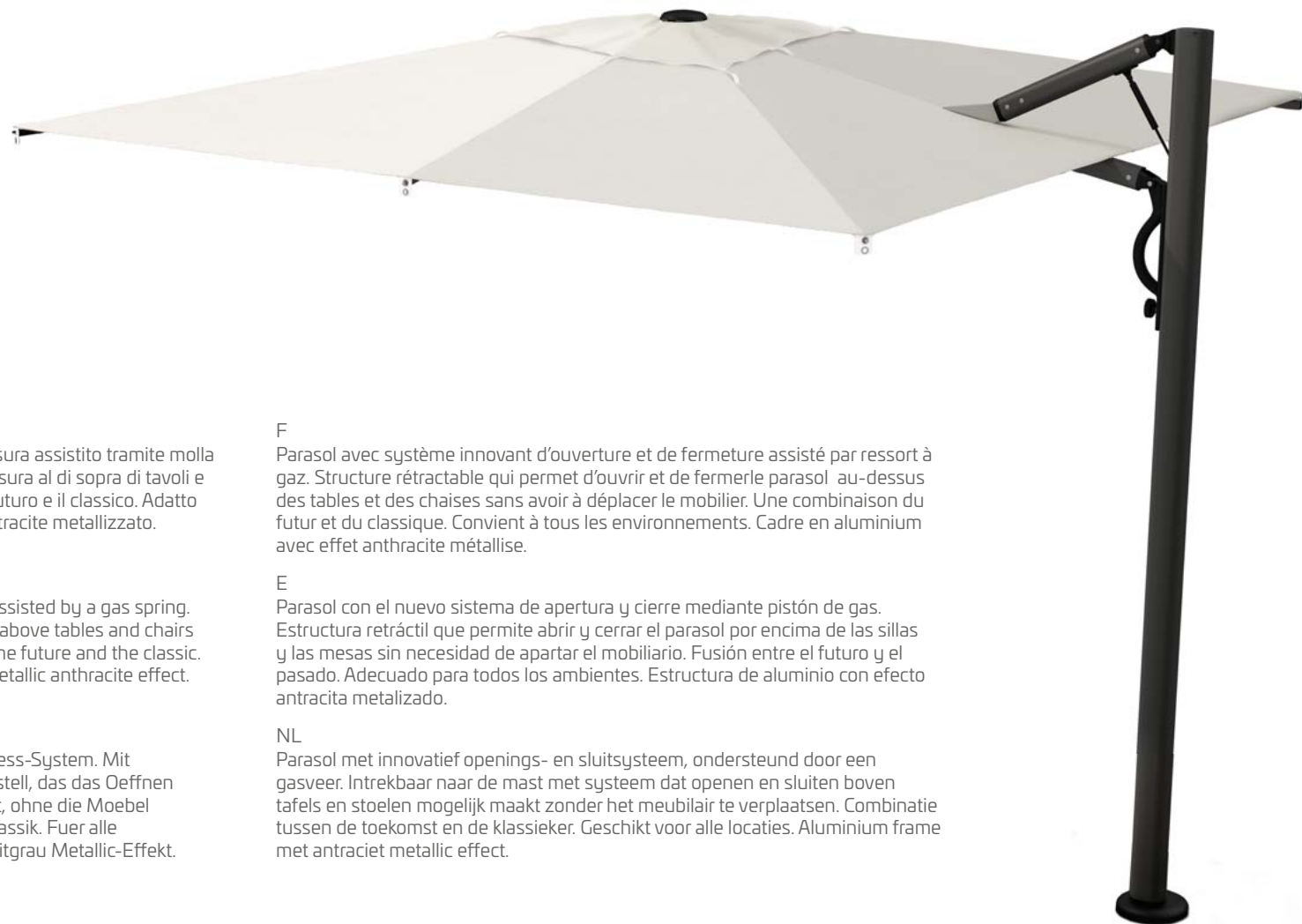

300x300	300x400
350x350	







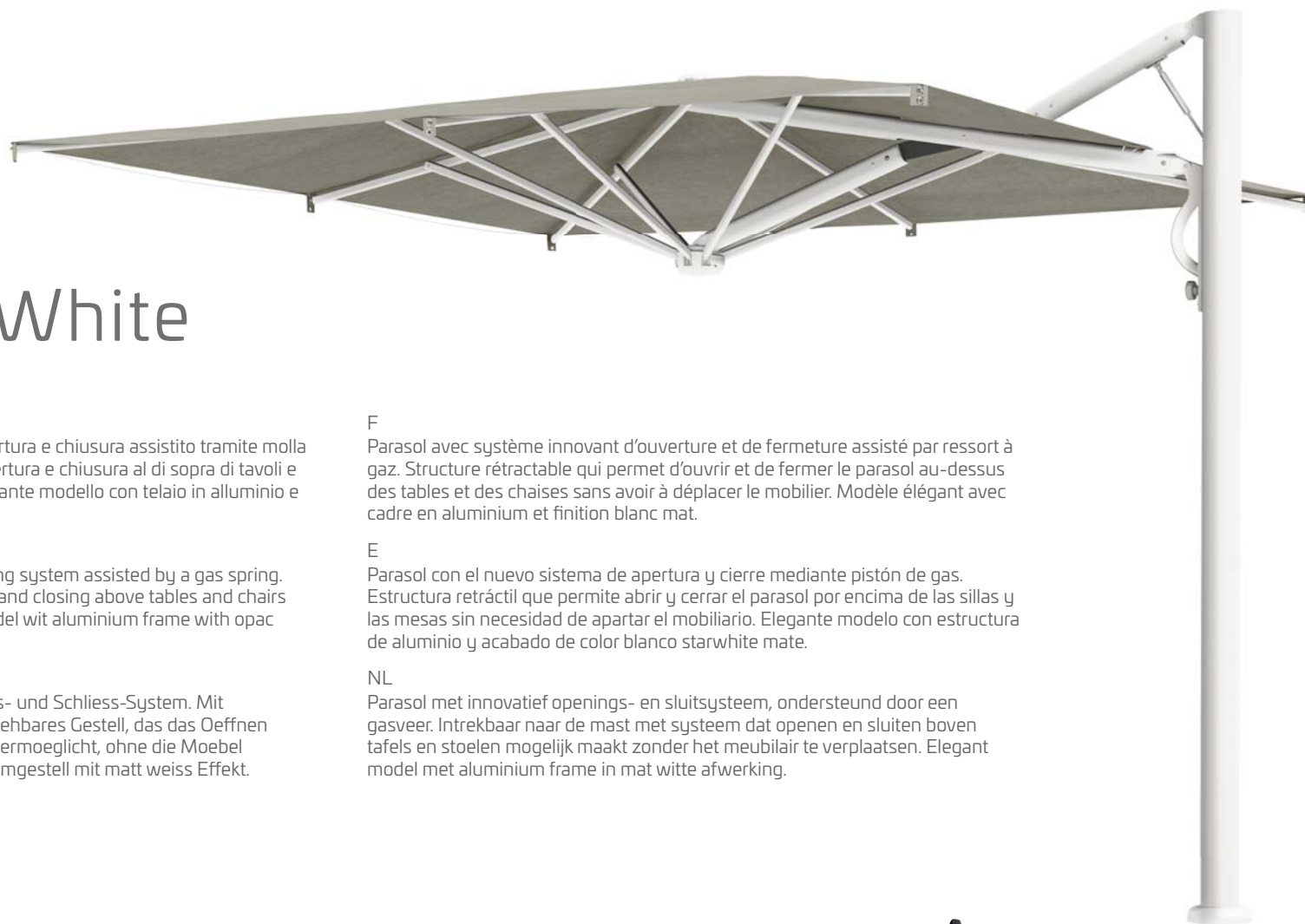

Astro StarWhite

I
Ombrellone con innovativo sistema di apertura e chiusura assistito tramite molla a gas. Struttura retrattile che permette apertura e chiusura al di sopra di tavoli e sedie senza dover spostare gli arredi. Elegante modello con telaio in alluminio e finitura colore bianco starwhite opaco.

EN
Parasol with innovative opening and closing system assisted by a gas spring. Retractable structure that allows opening and closing above tables and chairs without moving the furniture. Elegant model with aluminium frame with opac starwhite finish.

D
Sonnenschirm mit innovativem Oeffnungs- und Schliess-System. Mit Unterstuetzung durch eine Gasfeder Einziehbares Gestell, das das Oeffnen und Schliessen ueber Tische Und Stuehle ermoeglicht, ohne die Moebel umzuraeumen Elegantes Model. Aluminiumgestell mit matt weiss Effekt.

F
Parasol avec système innovant d'ouverture et de fermeture assisté par ressort à gaz. Structure rétractable qui permet d'ouvrir et de fermer le parasol au-dessus des tables et des chaises sans avoir à déplacer le mobilier. Modèle élégant avec cadre en aluminium et finition blanc mat.

E
Parasol con el nuevo sistema de apertura y cierre mediante pistón de gas. Estructura retráctil que permite abrir y cerrar el parasol por encima de las sillas y las mesas sin necesidad de apartar el mobiliario. Elegante modelo con estructura de aluminio y acabado de color blanco starwhite mate.

NL
Parasol met innovatief openings- en sluitsysteem, ondersteund door een gasveer. Intrekbaar naar de mast met systeem dat openen en sluiten boven tafels en stoelen mogelijk maakt zonder het meubilair te verplaatsen. Elegant model met aluminium frame in mat witte afwerking.

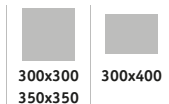







Astro Timber

i

Ombrellone con innovativo sistema di apertura e chiusura assistito tramite molla a gas. Struttura retrattile che permette apertura e chiusura al di sopra di tavoli e sedie senza dover spostare gli arredi. Telaio in alluminio e finitura effetto legno, trattamento resistente all'acqua salata e alla degradazione uv. Effetto innovativo e molto apprezzato nel settore outdoor.

EN

Parasol with innovative opening and closing system assisted by a gas spring. Retractable structure that allows opening and closing above tables and chairs without moving the furniture. With highly durable wood finish aluminum frame. Impervious to saltwater and uv degradation. An innovative and highly appreciated effect in the outdoor branch.

D

Sonnenschirm mit innovativem Oeffnungs- und Schliess-System. Mit Unterstuetzung durch eine Gasfeder Einziehbares Gestell, das das Oeffnen Und Schliessen ueber Tische Und Stuehle ermoeeglicht, ohne die Moebel umzuraeumen Aluminium Gestell mit Holzeffekt. Undurchlaessig gegen Salzwasser und Uv-Degradation Innovativ und hochgeschaetzt in der Outdoor-Branche.

F

Parasol avec système innovant d'ouverture et de fermeture assisté par ressort à gaz. Structure rétractable qui permet d'ouvrir et de fermer le parasol au-dessus des tables et des chaises sans avoir à déplacer le mobilier. Cadre en aluminium et finition effet bois, résistant au traitement à l'eau salée et à la dégradation uv. Effet innovant et très apprécié dans le secteur outdoor.



E

Parasol con el nuevo sistema de apertura y cierre mediante pistón de gas. Estructura retráctil que permite abrir y cerrar el parasol por encima de las sillas y las mesas sin necesidad de apartar el mobiliario. Estructura de aluminio y acabado efecto madera con tratamiento resistente al agua salina y a la degradación por los rayos uv. Acabado novedoso y muy apreciado en el sector outdoor.

NL

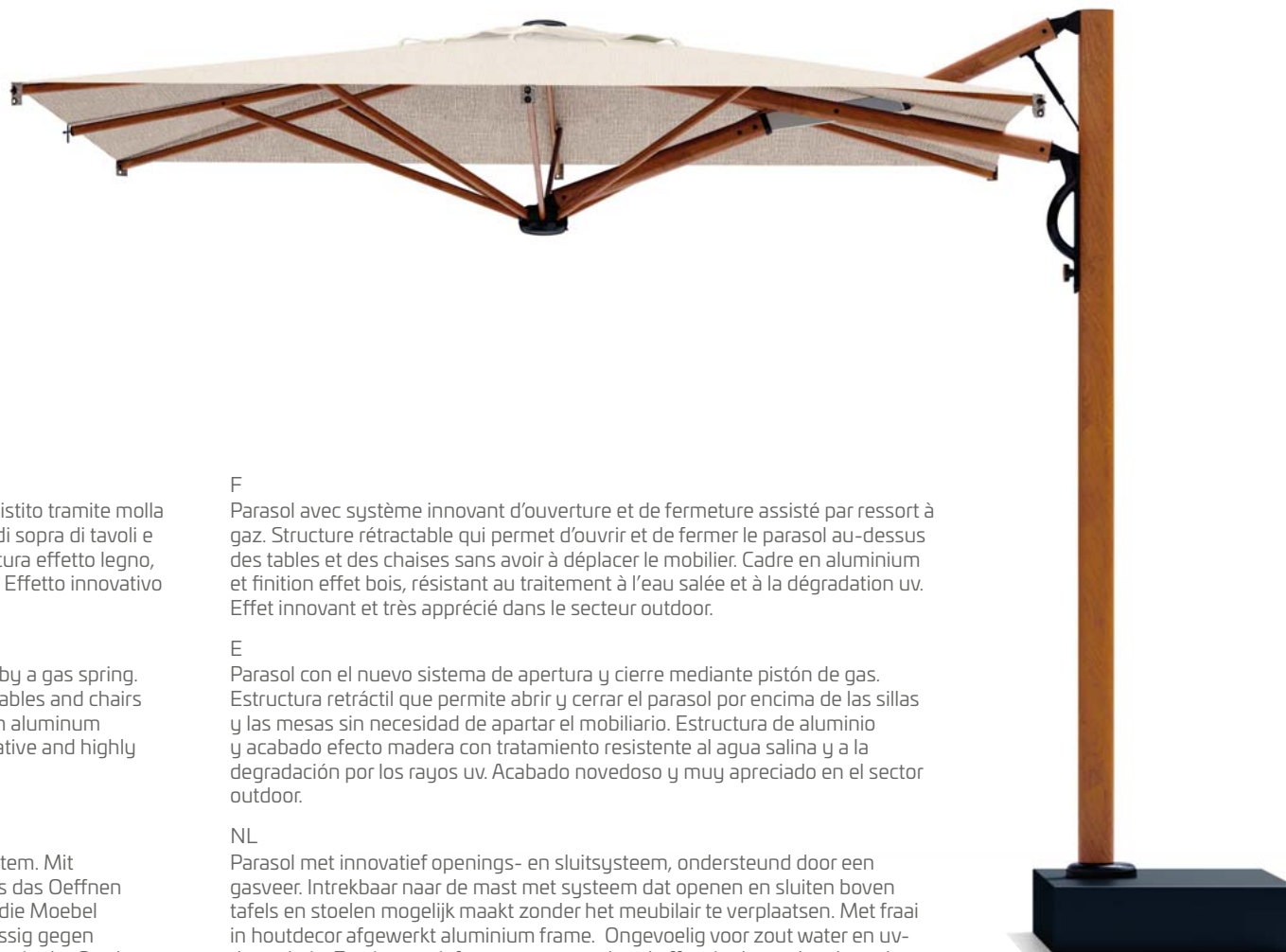
Parasol met innovatief openings- en sluitsysteem, ondersteund door een gasveer. Intrekbaar naar de mast met systeem dat openen en sluiten boven tafels en stoelen mogelijk maakt zonder het meubilair te verplaatsen. Met fraai in houtdecor afgewerkt aluminium frame. Ongevoelig voor zout water en uv-degradatie. Een innovatief en zeer gewaardeerd effect in de outdoor branche.



	
300x300 350x350	300x400



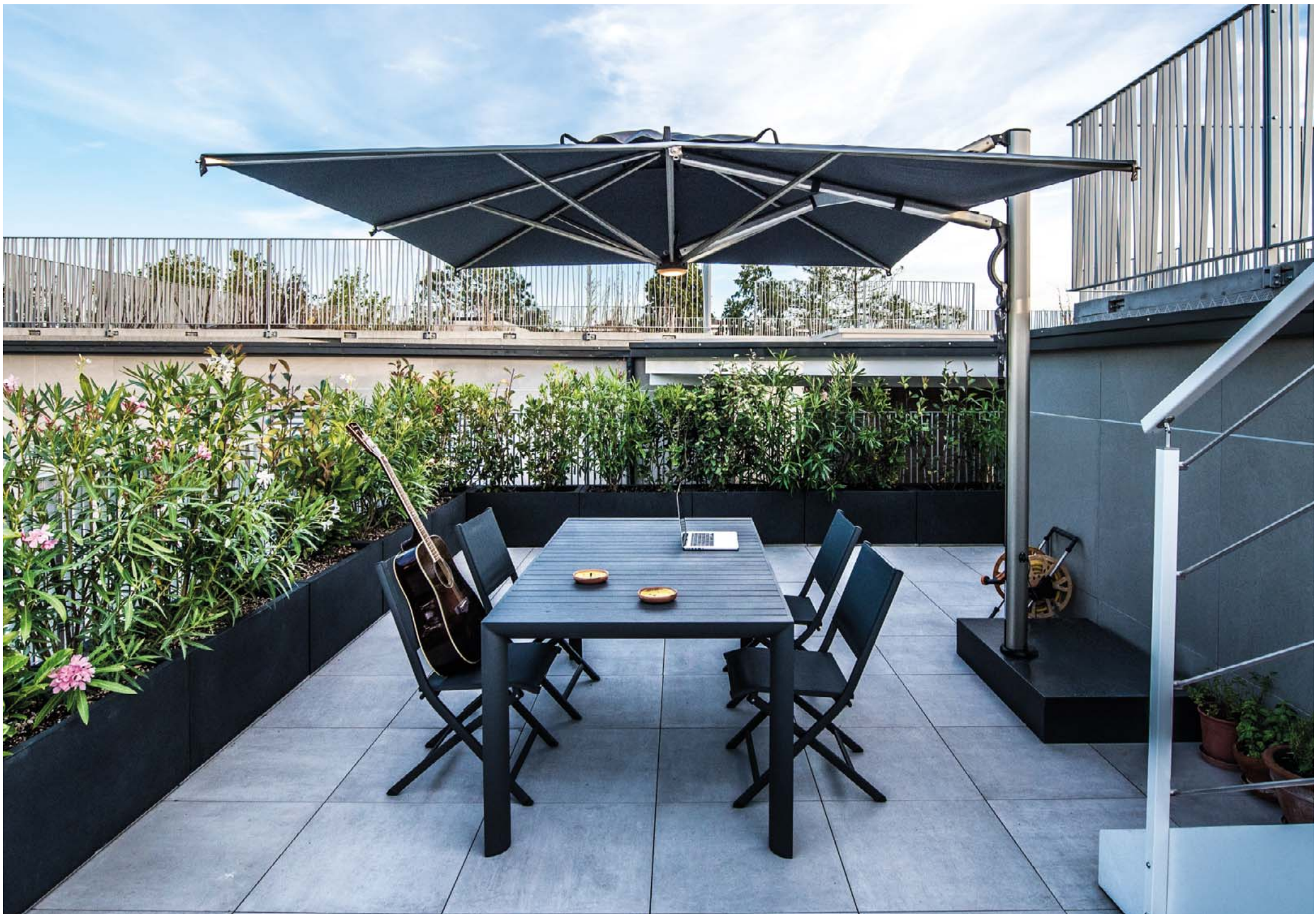



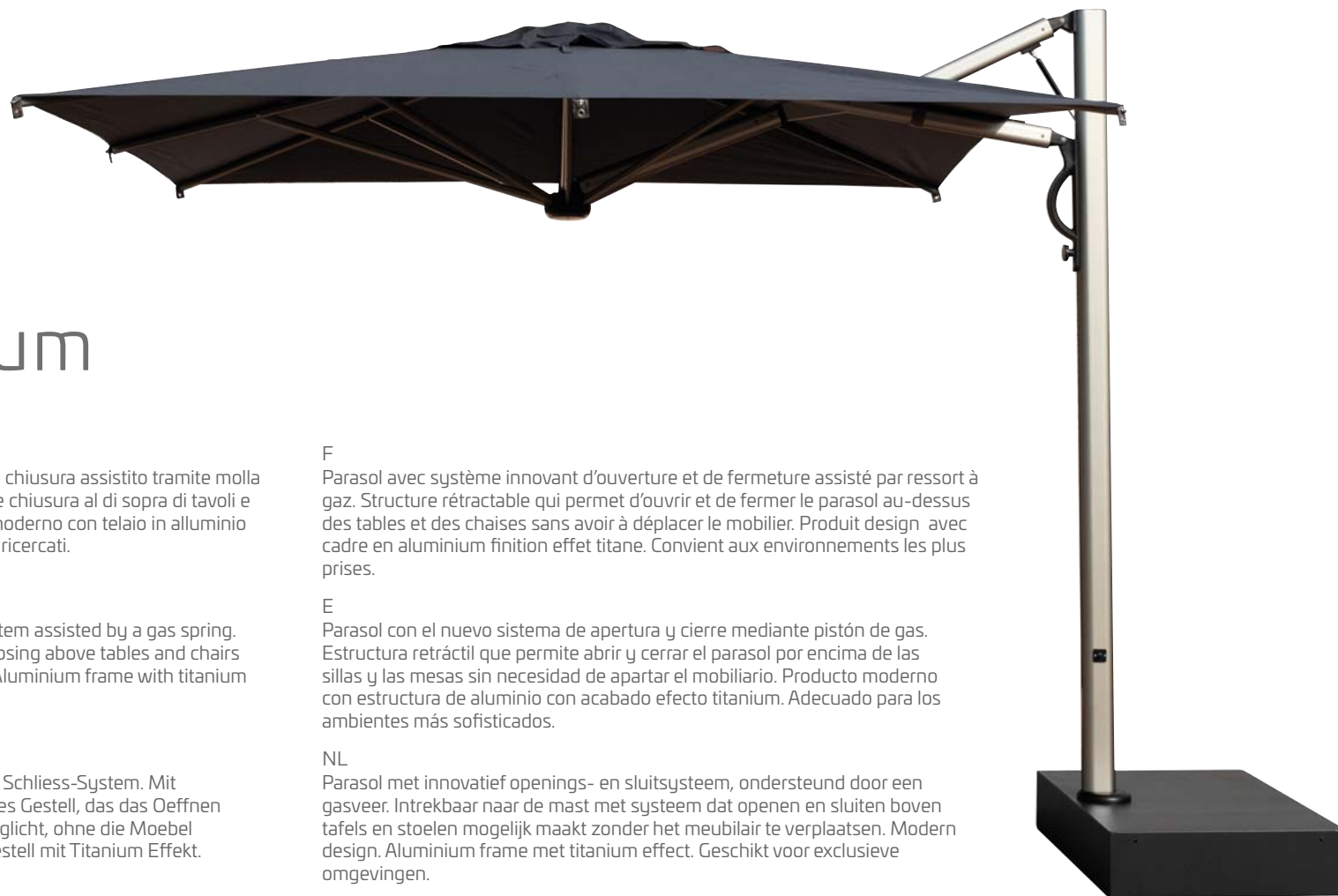

Astro Titanium

I
Ombrellone con innovativo sistema di apertura e chiusura assistito tramite molla a gas. Struttura retrattile che permette apertura e chiusura al di sopra di tavoli e sedie senza dover spostare gli arredi. Prodotto moderno con telaio in alluminio finitura effetto titanium. Adatto agli ambienti più ricercati.

EN
Parasol with innovative opening and closing system assisted by a gas spring. Retractable structure that allows opening and closing above tables and chairs without moving the furniture. Modern product. Aluminium frame with titanium effect. Suitable for exclusive environments.

D
Sonnenschirm mit innovativem Oeffnungs- und Schliess-System. Mit Unterstuetzung durch eine Gasfeder Einziehbares Gestell, das das Oeffnen und Schliessen ueber Tische und Stuehle ermoeglicht, ohne die Moebel umzuraeumen Modernes Produkt. Aluminiumgestell mit Titanium Effekt. Fuer exklusive Umgebungen geeignet.

F
Parasol avec système innovant d'ouverture et de fermeture assisté par ressort à gaz. Structure rétractable qui permet d'ouvrir et de fermer le parasol au-dessus des tables et des chaises sans avoir à déplacer le mobilier. Produit design avec cadre en aluminium finition effet titane. Convient aux environnements les plus prises.

E
Parasol con el nuevo sistema de apertura y cierre mediante pistón de gas. Estructura retráctil que permite abrir y cerrar el parasol por encima de las sillas y las mesas sin necesidad de apartar el mobiliario. Producto moderno con estructura de aluminio con acabado efecto titanium. Adecuado para los ambientes más sofisticados.

NL
Parasol met innovatief openings- en sluitsysteem, ondersteund door een gasveer. Intrekbaar naar de mast met systeem dat openen en sluiten boven tafels en stoelen mogelijk maakt zonder het meubilair te verplaatsen. Modern design. Aluminium frame met titanium effect. Geschikt voor exclusieve omgevingen.

300x300	300x400
350x350	





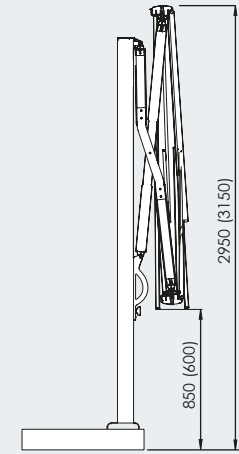
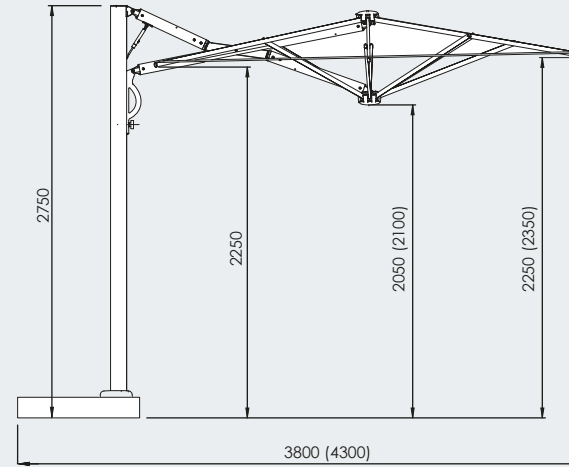
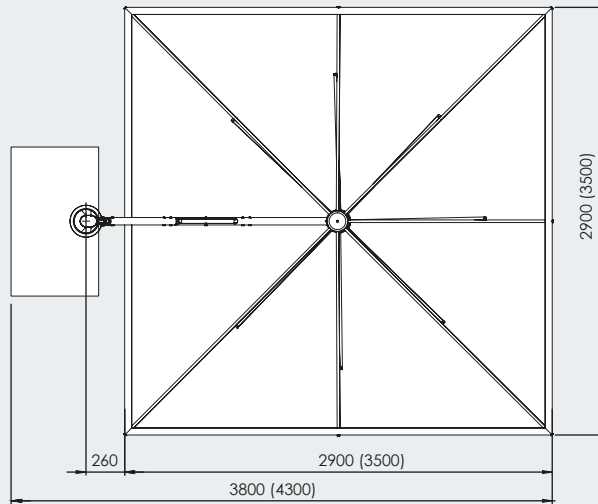

Astro

Carbon
StarWhite
Timber
Titanium

CHARACTERISTICS

FINISHING

		COD	KG													INOX
3,0x3,0		CARBON C3030 ASC	55	0,45	110x76	CARBON	8	CARBON	18x30	●	●	●	●	●	●	●
		STARWHITE C3030 ASW				STARWHITE		STARWHITE								
		TIMBER C3030 ASL				TIMBER		TIMBER								
		TITANIUM C3030 AST				TITANIUM		TITANIUM								
3,5x3,5		CARBON C3535 ASC	60	0,45	110x76	CARBON	8	CARBON	18x30	●	●	●	●	●	●	●
		STARWHITE C3535 ASW				STARWHITE		STARWHITE								
		TIMBER C3535 ASL				TIMBER		TIMBER								
		TITANIUM C3535 AST				TITANIUM		TITANIUM								
3,0x4,0		CARBON C3040 ASC	60	0,45	110x76	CARBON	8	CARBON	18x30	●	●	●	●	●	●	●
		STARWHITE C3040 ASW				STARWHITE		STARWHITE								
		TIMBER C3040 ASL				TIMBER		TIMBER								
		TITANIUM C3040 AST				TITANIUM		TITANIUM								

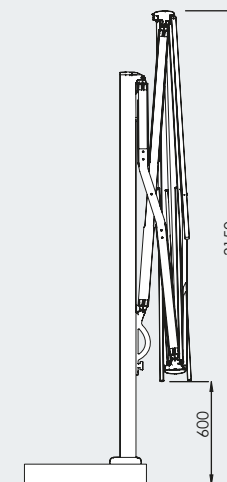
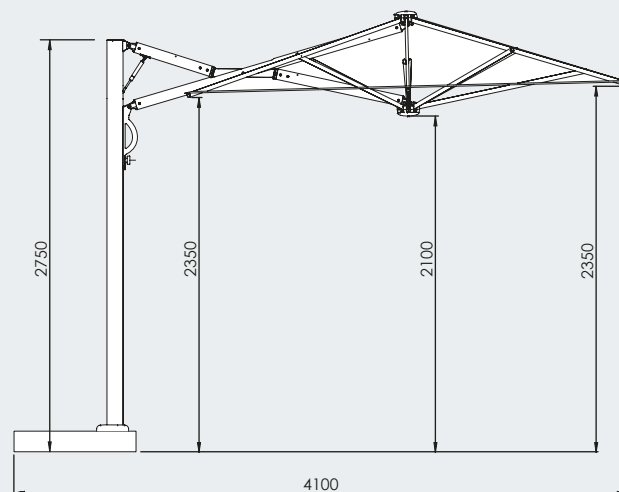
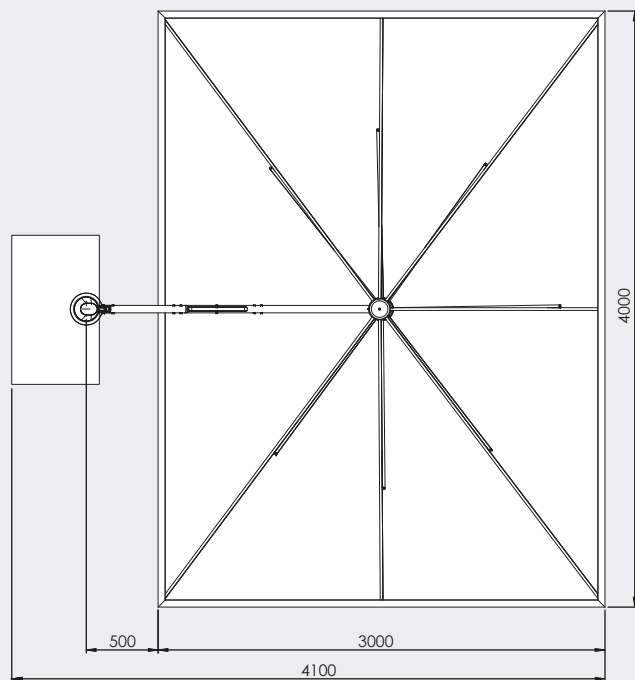

OPTIONAL

COLOUR RANGE
ACRYL 350 GR - PAG.53



	BASES - PAG.46/48			BALLAST PAG.49	GROUND FIXING - PAG.50	
●	●	B1DS	PL1DS	BUD8080DS	●	BTAS CP3030ZS CP6565ZS
		B1BS	PL1BS	BUD8080BS		
		B1DS	PL1DS	BUD8080DS		
		B1DS	PL1DS	BUD8080DS		
●	●	B1DS	PL1DS	BUD8080DS	●	BTAS CP3030ZS CP6565ZS
		B1BS	PL1BS	BUD8080BS		
		B1DS	PL1DS	BUD8080DS		
		B1DS	PL1DS	BUD8080DS		
●	●	B1DS	PL1DS	BUD8080DS	●	BTAS CP3030ZS CP6565ZS
		B1BS	PL1BS	BUD8080BS		
		B1DS	PL1DS	BUD8080DS		
		B1DS	PL1DS	BUD8080DS		

IT **IMPORTANTE!** BASE NON COMPRESA NEL PREZZO.
 UK **IMPORTANT!** BASE NOT INCLUDED IN THE PRICE.
 D **WICHTIG!** STAENDER IST NICHT IM PREIS ENTHALTEN.
 ES **IMPORTANTE!** BASE NO ESTA INCLUIDA EN EL PRECIO.
 NL **BELANGRIJK!** BASIS IS NIET INBEGREPEN IN DE PRIJS.

PAG. 51:
 - VERIFICA LA STABILITÀ
 - CHECK STABILITY
 - VÉRIFIEZ LA STABILITÉ
 - STABILITÄT PRÜFEN
 - COMPRUEBE LA ESTABILIDAD
 - CONTROLEER DE STABILITEIT



Dual "V" Carbon



I
Evoluzione dell'ombrellone singolo astro con innovativo sistema di apertura e chiusura assistito tramite molla a gas. Struttura retrattile che permette apertura e chiusura al di sopra di tavoli e sedie senza dover spostare gli arredi. Adatto per tutti gli ambienti e consigliato per uso professionale (bar, ristoranti, hotel e dehor). Telaio in alluminio con effetto antracite metallizzato. Struttura robusta composta da 2 ombrelloni affiancati ed ancorati ad un unico sostegno.

EN
Evolution of the single parasol astro with innovative opening and closing system assisted by a gas spring. Retractable structure that allows opening and closing above tables and chairs without moving the furniture. Suitable for all environments and recommended for a commercial employ (bars, restaurants, hotels and terrace dehors). Aluminum frame with metallic anthracite effect. Strong structure composed of 2 parasols side by side and anchored to a single support.

D
Entwicklung des Einzelschirmes Astro mit Innovativem Oeffnungs- und Schliess-System. Mit Unterstuetzung durch eine Gasfeder Einziehbares Gestell, das das Oeffnen und Schliessen ueber Tische und Stuehle ermoeoglicht, ohne die Moebel umzuraeumen Geeignet fuer alle Umgebungen und empfohlen fuer einen gewerblichen Einsatz (Bars, Restaurants, Hotels und Terrassen)
Aluminiumgestell mit Anthrazitgrau Metallic-Effekt Starkes Gestell, bestehend aus 2 Sonnenschirmen, die nebeneinander stehen und an einem Mast verankert sind.

F
Parasols double avec système innovant d'ouverture et de fermeture assisté par ressort à gaz. Structure rétractable qui permet d'ouvrir et de fermer les parasols au-dessus des tables et des chaises sans avoir à déplacer le mobilier. Convient à tous les environnements et recommandé pour un usage professionnel (bars, restaurants, hôtels, collectivites, chr....). Cadre en aluminium effet anthracite métalisée. Structure robuste composée de 2 parasols accroche à un seul mat.

E
Evolución del parasol individual astro con el nuevo sistema de apertura y cierre mediante pistón de gas. Estructura retráctil que permite abrir y cerrar el parasol por encima de las sillas y las mesas sin necesidad de apartar el mobiliario. Adecuado pata todos los ambientes y recomendado para uso profesional (bar, restaurantes, hoteles y espacios exteriores). Estructura de aluminio con efecto antracita metalizado. Estructura robusta compuesta por 2 parasoles juntos y soportados por un único palo.

NL
Evolutie van de enkele parasol astro met innovatief openings- en sluitsysteem ondersteund door een gasveer. Intrekbaar naar de mast met systeem dat openen en sluiten boven tafels en stoelen mogelijk maakt zonder het meubilair te verplaatsen. Geschikt voor alle locaties en aanbevolen voor een commerciële toepassing (bars, restaurants, hotels). Aluminium frame met antraciet metallic effect. Sterke constructie bestaande uit 2 parasols naast elkaar en verankerd aan een enkele mast.

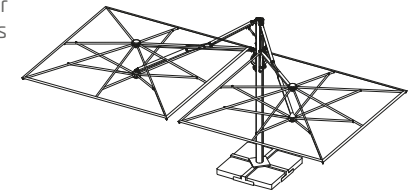

300x600





Dual "V" StarWhite



I
Evoluzione dell'ombrellone singolo astro con innovativo sistema di apertura e chiusura assistito tramite molla a gas. Struttura retrattile che permette apertura e chiusura al di sopra di tavoli e sedie senza dover spostare gli arredi. Adatto per tutti gli ambienti e consigliato per uso professionale (bar, ristoranti, hotel e dehor). Telaio in alluminio con verniciatura bianco starwhite opaco. Struttura robusta composta da 2 ombrelloni affiancati ed ancorati ad un unico sostegno.

EN
Evolution of the single parasol astro with innovative opening and closing system assisted by a gas spring. Retractable structure that allows opening and closing above tables and chairs without moving the furniture. Suitable for all environments and recommended for a commercial employ (bars, restaurants, hotels and terrace dehors). Aluminium frame with opac starwhite finish. Strong structure composed of 2 parasols side by side and anchored to a single support.

D
Entwicklung des Einzelschirmes Astro mit innovativem Öffnungs- und Schliess-System. Mit Unterstuetzung durch eine Gasfeder Einziehbares Gestell, das das Öffnen und Schliessen ueber Tische und Stuehle ermoeoglicht, ohne die Moebel umzuraeumen Geeignet fuer alle Umgebungen und empfohlen fuer einen gewerblichen Einsatz (Bars, Restaurants, Hotels Und Terrassen) Aluminiumgestell mit matt weiss Effekt Starkes Gestell, bestehend aus 2 Sonnenschirmen, die nebeneinander stehen und an einem Mast verankert sind.

F
Parasols double avec système innovant d'ouverture et de fermeture assisté par ressort à gaz. Structure rétractable qui permet d'ouvrir et de fermer les parasols au-dessus des tables et des chaises sans avoir à déplacer le mobilier. Convient à tous les environnements et recommandé pour un usage professionnel (bars, restaurants, hôtels, collectivité . Chr....). Cadre en aluminium coloris blanc mate. Structure robuste composée de 2 parasols accroche a un seul support.

E
Evolución del parasol individual astro con el nuevo sistema de apertura y cierre mediante pistón de gas. Estructura retráctil que permite abrir y cerrar el parasol por encima de las sillas y las mesas sin necesidad de apartar el mobiliario. Adecuado pata todos los ambientes y recomendado para uso profesional (bar, restaurantes,hoteles y espacios exteriores). Estructura de aluminio con pintura blanca starwhite mate. Estructura robusta compuesta por 2 parasoles juntos y soportados por un único palo.

NL
Evolutie van de enkele parasol astro met innovatief openings- en sluitsysteem ondersteund door een gasveer. Intrekbaar naar de mast met systeem dat openen en sluiten boven tafels en stoelen mogelijk maakt zonder het meubilair te verplaatsen. Geschikt voor alle locaties en aanbevolen voor een commerciële toepassing (bars, restaurants, hotels). Aluminium frame in mat wit. Sterke constructie bestaande uit 2 parasols naast elkaar en verankerd aan een enkele mast.

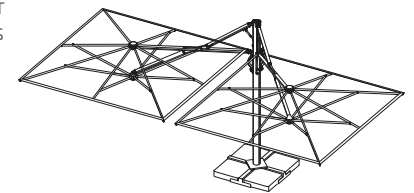

300x600







Dual "V" Timber

I

Evoluzione dell'ombrellone singolo astro con innovativo sistema di apertura e chiusura assistito tramite molla a gas. Struttura retrattile che permette apertura e chiusura al di sopra di tavoli e sedie senza dover spostare gli arredi. Adatto per tutti gli ambienti e consigliato per uso professionale (bar, ristoranti, hotel e dehor). Telaio in alluminio e finitura effetto legno, trattamento resistente all'acqua salata e alla degradazione uv. Effetto innovativo e molto apprezzato nel settore outdoor. Struttura robusta composta da 2 ombrelloni affiancati ed ancorati ad un unico sostegno.

EN

Evolution of the single parasol astro with innovative opening and closing system assisted by a gas spring. Retractable structure that allows opening and closing above tables and chairs without moving the furniture. Suitable for all environments and recommended for a commercial employ (bars, restaurants, hotels and terrace dehors). With highly durable wood finish aluminum frame. Impervious to saltwater and uv degradation. An innovative and highly appreciated effect in the outdoor branch. Strong structure composed of 2 parasols side by side and anchored to a single support.

D

Entwicklung des Einzelschirmes Astro mit innovativem Oeffnungs- und Schliesssystem. Mit Unterstuetzung durch eine Gasfeder Einziehbares Gestell, das das Oeffnen und Schliessen ueber Tische Und Stuehle ermoeglicht, ohne die Moebel umzuraeumen Geeignet fuer alle Umgebungen und empfohlen fuer einen gewerblichen Einsatz (Bars, Restaurants, Hotels Und Terrassen) Aluminium Gestell mit Holzeffekt. Undurchlaessig gegen Salzwasser und Uv-Degradation Innovativ und hochgeschaeztzt in der Outdoor-Branche. Starkes Gestell, bestehend aus 2 Sonnenschirmen, die nebeneinander stehen und an einem Mast verankert sind.

F

Parasols double avec système innovant d'ouverture et de fermeture assisté par ressort à gaz. Structure rétractable qui permet d'ouvrir et de fermer les parasols au-dessus des tables et des chaises sans avoir à déplacer le mobilier. Convient à tous les environnements et recommandé pour un usage professionnel (bars, restaurants, collectivités, chr....). Cadre en aluminium effet bois. Traitement résistant à l'eau salée et à la dégradation par les uv. Effet innovant et très apprécié dans le secteur outdoor. Structure robuste composée de 2 parasols accroché à un seul mat.

E

Evolución del parasol individual astro con el nuevo sistema de apertura y cierre mediante pistón de gas. Estructura retráctil que permite abrir y cerrar el parasol por encima de las sillas y las mesas sin necesidad de apartar el mobiliario. Adecuado pata todos los ambientes y recomendado para uso profesional (bar, restaurantes, hoteles y espacios exteriores). Estructura de aluminio y acabado efecto madera con tratamiento resistente al agua salina y a la degradación por los rayos uv. Acabado novedoso y muy apreciado en el sector outdoor. Estructura robusta compuesta por 2 parasoles juntos y soportados por un único palo.

NL

Evolutie van de enkele parasol astro met innovatief openings- en sluitsysteem ondersteund door een gasveer. Intrekbaar naar de mast met systeem dat openen en sluiten boven tafels en stoelen mogelijk maakt zonder het meubilair te verplaatsen. Geschikt voor alle locaties en aanbevolen voor een commerciële toepassing (bars, restaurants, hotels). Met fraai in houtdecor afgewerkt aluminium frame. Ongevoelig voor zout water en uv-degradatie. Sterke constructie bestaande uit 2 parasols naast elkaar en verankerd aan een enkele mast.

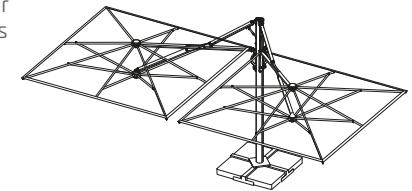

300x600



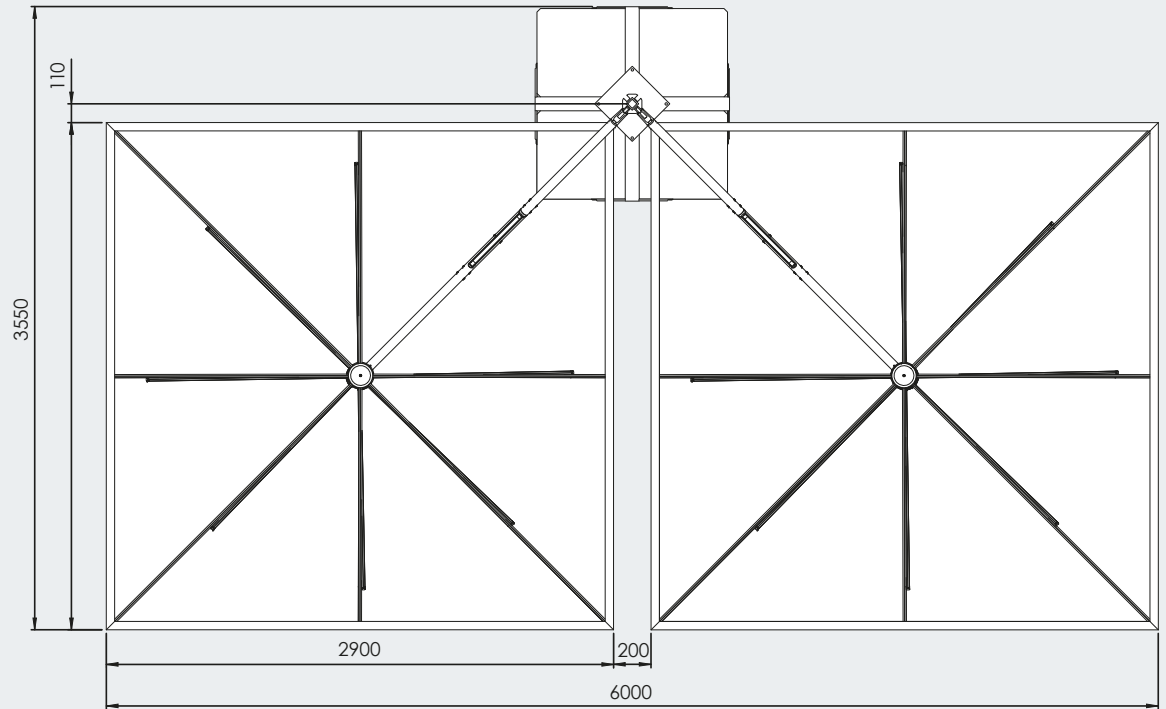

Dual-V

Carbon
StarWhite
Timber

3,0x6,0

CHARACTERISTICS

FINISHING

	COD													INOX													
	CARBON C3060 DVC														120	0,60	110x110	CARBON	8	CARBON	18x30	●	●	●	●	●	●
	STARWHITE C3060 DVW																	STARWHITE		STARWHITE							
	TIMBER C3060 DVL																	TIMBER		TIMBER							

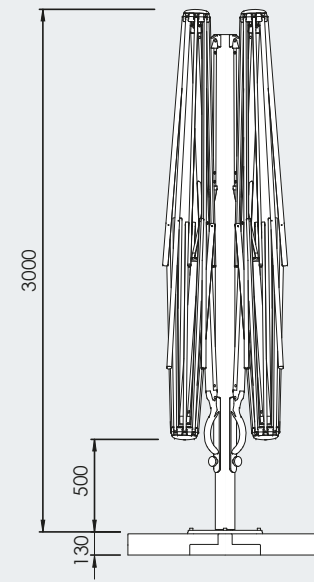
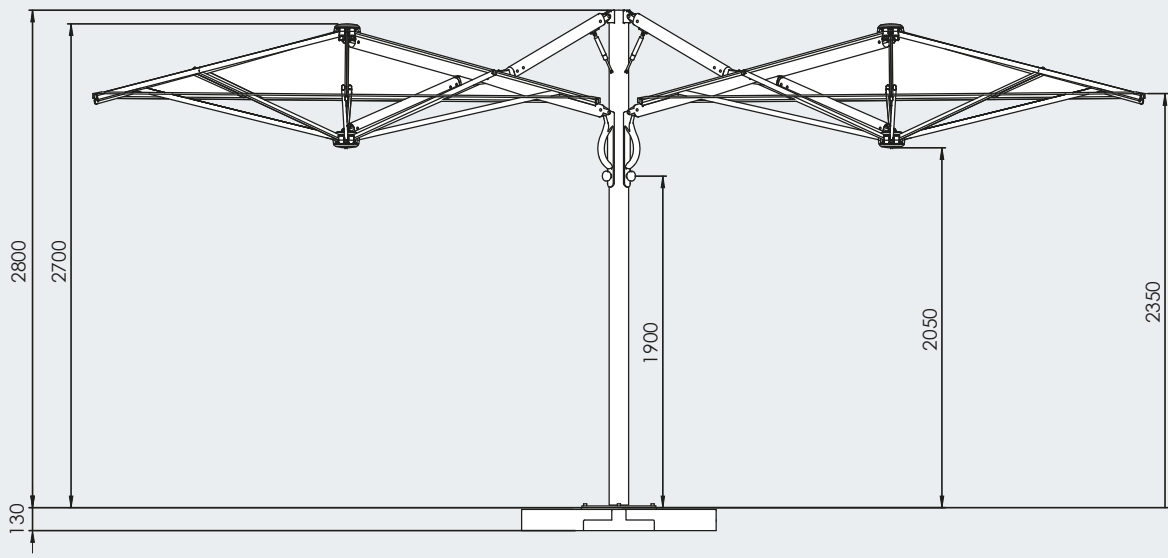

OPTIONAL

COLOUR RANGE
ACRYL 350 GR - PAG.53



A1N - T2N - T3N - T6N
T7N - T8N - T9N - S1N

	BASES - PAG.46/48		BALLAST PAG.49	GROUND FIXING - PAG.50	
●	PL1DS	BUD8080DS	●	BTBS	CP6565ZS
	PL1BS	BUD8080BS			
	PL1DS	BUD8080DS			

IT **IMPORTANTE!** BASE NON COMPRESA NEL PREZZO.
 UK **IMPORTANT!** BASE NOT INCLUDED IN THE PRICE.
 D **WICHTIG!** STAENDER IST NICHT IM PREIS ENTHALTEN.
 ES **IMPORTANTE!** BASE NO ESTA INCLUIDA EN EL PRECIO.
 NL **BELANGRIJK!** BASIS IS NIET INBEGREPEN IN DE PRIJS.

👁️ **PAG. 51:** VERIFICA LA STABILITÀ - CHECK STABILITY - VÉRIFIEZ LA STABILITÉ - STABILITÄT PRÜFEN
 COMPROBE LA ESTABILIDAD - CONTROLEER DE STABILITEIT



Dual "T" Carbon



I
Evoluzione dell'ombrellone singolo astro con innovativo sistema di apertura e chiusura assistito tramite molla a gas. Struttura retrattile che permette apertura e chiusura al di sopra di tavoli e sedie senza dover spostare gli arredi. Adatto per tutti gli ambienti e consigliato per uso professionale (bar, ristoranti, hotel e dehor). Telaio in alluminio con effetto antracite metallizzato. Struttura robusta composta da 2 ombrelloni opposti ancorati ad un unico sostegno e posizionati in modo simmetrico.

EN
Evolution of the single parasol astro with innovative opening and closing system assisted by a gas spring. Retractable structure that allows opening and closing above tables and chairs without moving the furniture. Suitable for all environments and recommended for a commercial employ (bars, restaurants, hotels and terrace dehors). Aluminum frame with metallic anthracite effect. Strong structure composed of 2 parasols anchored to a single support and positioned in a symmetrical way.

D
Entwicklung des Einzelschirmes Astro mit innovativem Oeffnungs- und Schliesssystem. Mit Unterstuetzung durch eine Gasfeder Einziehbares Gestell, das das Oeffnen und Schliessen ueber Tische und Stuehle ermöglicht, ohne die Moebel umzuraeumen Geeignet fuer alle Umgebungen und empfohlen fuer einen gewerblichen Einsatz (Bars, Restaurants, Hotels Und Terrassen) Aluminiumgestell mit anthrazitgrau Metallic-Effekt Starkes Gestell, bestehend aus 2 Sonnenschirmen, sie symmetrisch an einem Mast verankert sind.

F
Parasols double avec système innovant d'ouverture et de fermeture assisté par ressort à gaz. Structure rétractable qui permet d'ouvrir et de fermer les parasols au-dessus des tables et des chaises sans avoir à déplacer le mobilier. Convient à tous les environnements et recommandé pour un usage professionnel (bars, restaurants, collectivites, chr....). Cadre en aluminium effet anthracite métalise. Structure robuste composée de 2 parasols accroche à un seul mat et positionnes symetriquement.

E
Evolución del parasol individual astro con el nuevo sistema de apertura y cierre mediante pistón de gas. Estructura retráctil que permite abrir y cerrar el parasol por encima de las sillas y las mesas sin necesidad de apartar el mobiliario. Adecuado pata todos los ambientes y recomendado para uso profesional (bar, restaurantes, hoteles y espacios exteriores). Estructura de aluminio con efecto antracita metalizado. Estructura robusta compuesta por 2 parasoles opuestos y soportados por un único palo, posicionados en modo simétrico.

NL
Evolutie van de enkele parasol astro met innovatief openings- en sluitsysteem ondersteund door een gasveer. Intrekbaar naar de mast met systeem dat openen en sluiten boven tafels en stoelen mogelijk maakt zonder het meubilair te verplaatsen. Geschikt voor alle locaties en aanbevolen voor een commerciële toepassing (bars, restaurants, hotels). Aluminium frame met antraciet metallic effect. Sterke constructie bestaande uit 2 parasols symmetrisch naast elkaar en verankerd aan een enkele mast.

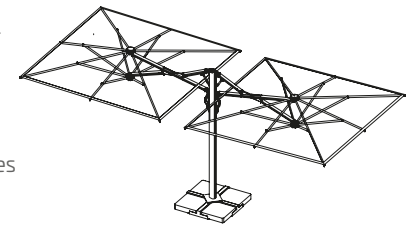

300x600
350x700





Dual "T" StarWhite



I
Evoluzione dell'ombrellone singolo astro con innovativo sistema di apertura e chiusura assistito tramite molla a gas. Struttura retrattile che permette apertura e chiusura al di sopra di tavoli e sedie senza dover spostare gli arredi. Adatto per tutti gli ambienti e consigliato per uso professionale (bar, ristoranti, hotel e dehor). Telaio in alluminio con verniciatura bianco starwhite opaco. Struttura robusta composta da 2 ombrelloni opposti ancorati ad un unico sostegno e posizionati in modo simmetrico.

EN
Evolution of the single parasol astro with innovative opening and closing system assisted by a gas spring. Retractable structure that allows opening and closing above tables and chairs without moving the furniture. Suitable for all environments and recommended for a commercial employ (bars, restaurants, hotels and terrace dehors). Aluminium frame with opac starwhite finish. Strong structure composed of 2 parasols anchored to a single support and positioned in a symmetrical way.

D
Entwicklung des Einzelschirmes Astro mit innovativem Oeffnungs- und Schliesssystem. Mit Unterstuetzung durch eine Gasfeder Einziehbares Gestell, das das Oeffnen und Schliessen ueber Tische und Stuehle ermöglicht, ohne die Moebel umzuraeumen Geeignet fuer alle Umgebungen und empfohlen fuer einen gewerblichen Einsatz (Bars, Restaurants, Hotels Und Terrassen) Aluminiumgestell mit matt weiss Effekt Starkes Gestell, bestehend aus 2 Sonnenschirmen, die symmetrisch an einem Mast verankert Sind.

F
Parasols double avec système innovant d'ouverture et de fermeture assisté par ressort à gaz. Structure rétractable qui permet d'ouvrir et de fermer les parasols au-dessus des tables et des chaises sans avoir à déplacer le mobilier. Convient à tous les environnements et recommandé pour un usage professionnel (bars, restaurants, collectivite , ch....). Cadre en aluminium coloris blanc mate. Structure robuste composée de 2 parasols accroche a un seul support mat et positionnes symetriquement.

E
Evolución del parasol individual astro con el nuevo sistema de apertura y cierre mediante pistón de gas. Estructura retráctil que permite abrir y cerrar el parasol por encima de las sillas y las mesas sin necesidad de apartar el mobiliario. Adecuado pata todos los ambientes y recomendado para uso profesional (bar, restaurantes,hoteles y espacios exteriores). Estructura de aluminio con pintura blanca starwhite mate. Estructura robusta compuesta por 2 parasoles opuestos, soportados por un único palo y posicionados en modo simétrico.

NL
Evolutie van de enkele parasol astro met innovatief openings- en sluitsysteem ondersteund door een gasveer. Intrekbaar naar de mast met systeem dat openen en sluiten boven tafels en stoelen mogelijk maakt zonder het meubilair te verplaatsen. Geschikt voor alle locaties en aanbevolen voor een commerciële toepassing (bars, restaurants, hotels). Aluminium frame in mat wit. Sterke constructie bestaande uit 2 parasols symmetrisch naast elkaar en verankerd aan een enkele mast.

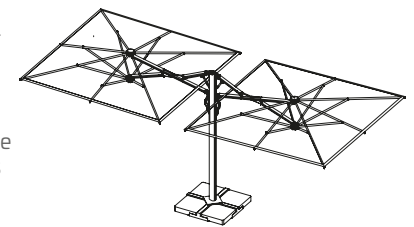

300x600
350x700







Dual "T" Timber

I
Evoluzione dell'ombrellone singolo astro con innovativo sistema di apertura e chiusura assistito tramite molla a gas. Struttura retrattile che permette apertura e chiusura al di sopra di tavoli e sedie senza dover spostare gli arredi. Adatto per tutti gli ambienti e consigliato per uso professionale (bar, ristoranti, hotel e dehor). Telaio in alluminio e finitura effetto legno, trattamento resistente all'acqua salata e alla degradazione uv. Effetto innovativo e molto apprezzato nel settore outdoor. Struttura robusta composta da 2 ombrelloni opposti ancorati ad un unico sostegno e posizionati in modo simmetrico.

EN
Evolution of the single parasol astro with innovative opening and closing system assisted by a gas spring. Retractable structure that allows opening and closing above tables and chairs without moving the furniture. Suitable for all environments and recommended for a commercial employ (bars, restaurants, hotels and terrace dehors). With highly durable wood finish aluminum frame. Impervious to saltwater and uv degradation. An innovative and highly appreciated effect in the outdoor branch. Strong structure composed of 2 parasols anchored to a single support and positioned in a symmetrical way.

D
Entwicklung des Einzelschirmes Astro mit innovativem Oeffnungs- und Schliesssystem. Mit Unterstuetzung durch eine Gasfeder Einziehbares Gestell, das das Oeffnen und Schliessen ueber Tische und Stuehle ermoeglicht, ohne die Moebel umzuräumen Geeignet fuer alle Umgebungen und empfohlen fuer einen gewerblichen Einsatz (Bars, Restaurants, Hotels Und Terrassen) Aluminium Gestell mit Holzeffekt. Undurchlaessig gegen Salzwasser und Uv-Degradation Innovativ und hochgeschaeztz in der Outdoor-Branche. Starkes Gestell, bestehend aus 2 Sonnenschirmen, die symmetrisch an einem Mast verankert sind.

F
Parasols double avec système innovant d'ouverture et de fermeture assisté par ressort à gaz. Structure rétractable qui permet d'ouvrir et de fermer les parasols au-dessus des tables et des chaises sans avoir à déplacer le mobilier. Convient à tous les environnements et recommandé pour un usage professionnel (bars, restaurants, collectivities, chr...). Cadre en aluminium effet bois. Traitement résistant à l'eau salée et à la dégradation par les uv. Effet innovant et très apprécié dans le secteur outdoor. Structure robuste composée de 2 parasols accroche à un seul support mat et positionnes symetriquement.

E
Evolución del parasol individual astro con el nuevo sistema de apertura y cierre mediante pistón de gas. Estructura retráctil que permite abrir y cerrar el parasol por encima de las sillas y las mesas sin necesidad de apartar el mobiliario. Adecuado pata todos los ambientes y recomendado para uso profesional (bar, restaurantes, hoteles y espacios exteriores). Estructura de aluminio y acabado efecto madera con tratamiento resistente al agua salina y a la degradación por los rayos uv. Acabado novedoso y muy apreciado en el sector outdoor. Estructura robusta compuesta por 2 parasoles opuestos, soportados por un único palo y posicionados en modo simétrico.

NL
Evolutie van de enkele parasol astro met innovatief openings- en sluitsysteem ondersteund door een gasveer. Intrekbaar naar de mast met systeem dat openen en sluiten boven tafels en stoelen mogelijk maakt zonder het meubilair te verplaatsen. Geschikt voor alle locaties en aanbevolen voor een commerciële toepassing (bars, restaurants, hotels). Met fraai in houtdecor afgewerkt aluminium frame. Ongevoelig voor zout water en uv-degradatie. Sterke constructie bestaande uit 2 parasols symetrisch naast elkaar en verankerd aan een enkele mast.

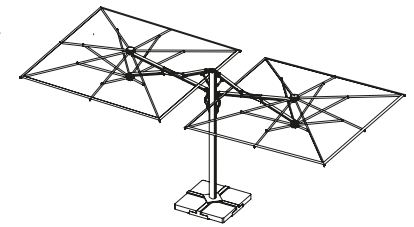

300x600
350x700



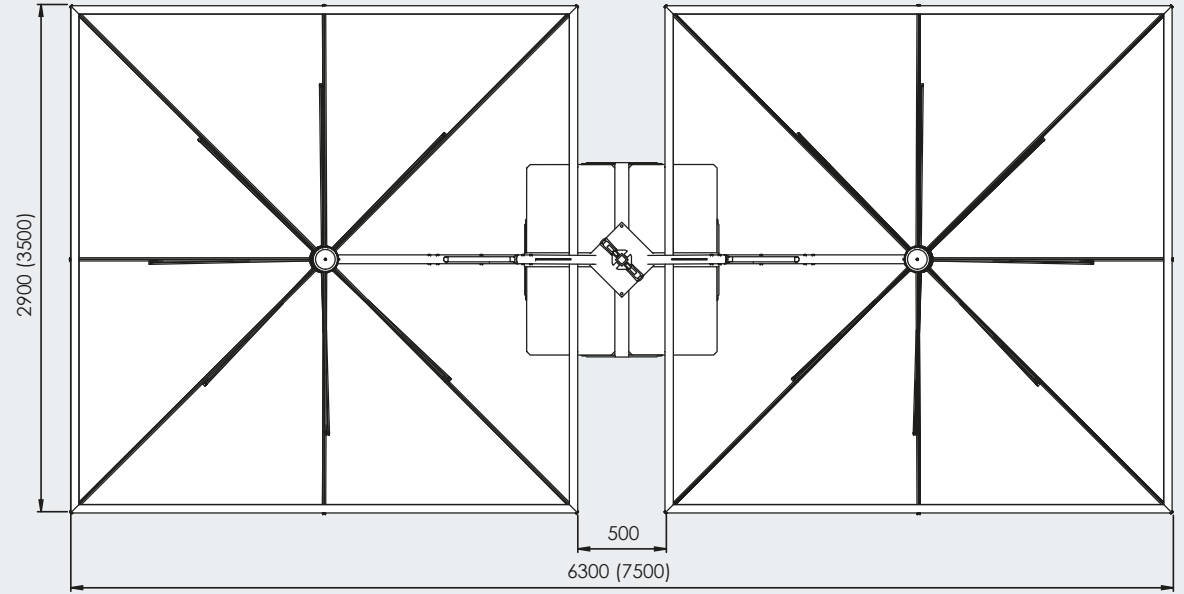

Dual-T

Carbon
StarWhite
Timber

		CHARACTERISTICS								FINISHING					
3,0x6,0	CARBON C3060 DTC	120	0,60	110x110	CARBON	8	CARBON	18x30	●	●	●	●	●	●	
	STARWHITE C3060 DTW				STARWHITE		STARWHITE								
	TIMBER C3060 DTL				TIMBER		TIMBER								
3,5x7,0	CARBON C3570 DTC	125	0,60	110x110	CARBON	8	CARBON	18x30	●	●	●	●	●	●	
	STARWHITE C3570 DTW				STARWHITE		STARWHITE								
	TIMBER C3570 DTL				TIMBER		TIMBER								

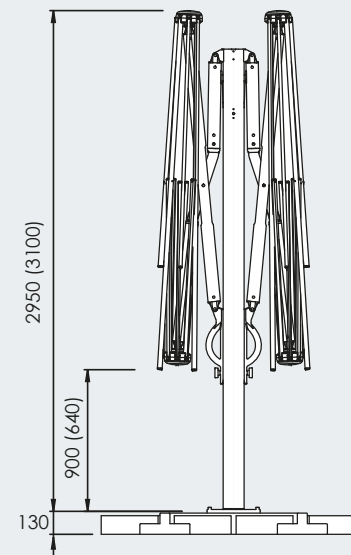
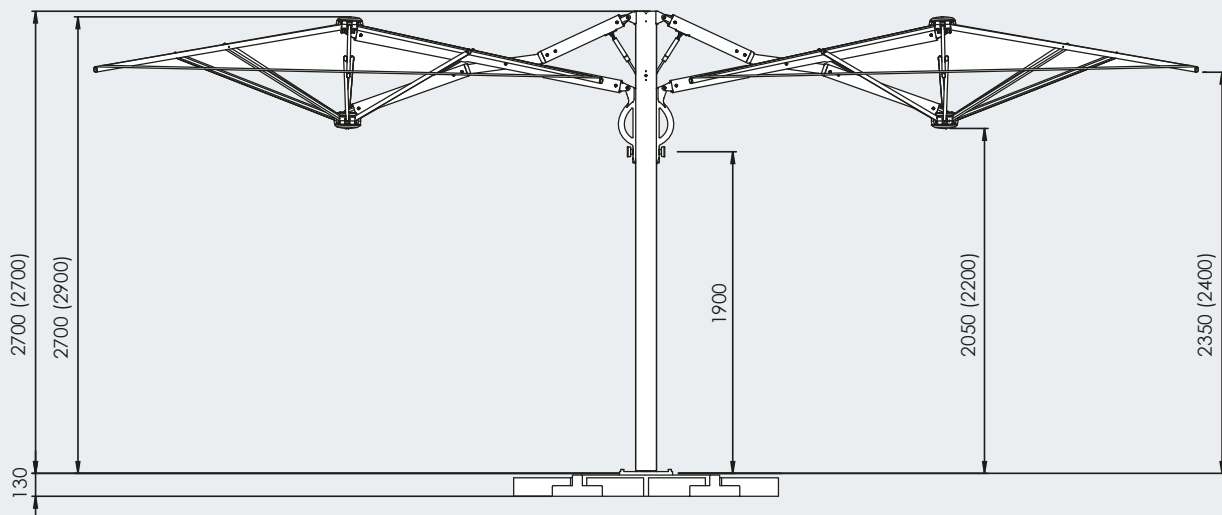

OPTIONAL

COLOUR RANGE
ACRYL 350 GR - PAG.53



	BASES - PAG.46/48		BALLAST PAG.49	GROUND FIXING - PAG.50	
●	●	PL1DS BUD8080DS			
		PL1BS BUD8080BS	●	BTBS	CP6565ZS
		PL1DS BUD8080DS			
●	●	PL1DS BUD8080DS			
		PL1BS BUD8080BS	●	BTBS	CP6565ZS
		PL1DS BUD8080DS			

IT **IMPORTANTE!** BASE NON COMPRESA NEL PREZZO.
 UK **IMPORTANT!** BASE NOT INCLUDED IN THE PRICE.
 D **WICHTIG!** STAENDER IST NICHT IM PREIS ENTHALTEN.
 ES **IMPORTANTE!** BASE NO ESTA INCLUIDA EN EL PRECIO.
 NL **BELANGRIJK!** BASIS IS NIET INBEGREPEN IN DE PRIJS.

👁️ **PAG. 51:** VERIFICA LA STABILITÀ - CHECK STABILITY - VÉRIFIEZ LA STABILITÉ - STABILITÄT PRÜFEN
 COMPROBE LA ESTABILIDAD - CONTROLEER DE STABILITEIT



Quattro Carbon



I
Evoluzione dell'ombrellone singolo astro con innovativo sistema di apertura e chiusura assistito tramite molla a gas. Struttura retrattile che permette apertura e chiusura al di sopra di tavoli e sedie senza dover spostare gli arredi. Adatto per tutti gli ambienti e consigliato per uso professionale (bar, ristoranti, hotel e dehor). Telaio in alluminio con effetto antracite metallizzato. Struttura robusta composta da 4 ombrelloni ancorati ad un unico sostegno.

EN
Evolution of the single parasol astro with innovative opening and closing system assisted by a gas spring. Retractable structure that allows opening and closing above tables and chairs without moving the furniture. Suitable for all environments and recommended for a commercial employ (bars, restaurants, hotels and terrace dehors). Aluminum frame with metallic anthracite effect. Strong structure composed of 4 parasols anchored to a single support.

D
Entwicklung des Einzelschirmes Astro mit innovativem Oeffnungs- und Schliesssystem. Mit Unterstuetzung durch eine Gasfeder Einziehbares Gestell, das das Oeffnen dnd Schliessen ueber Tische und Stuehle ermoeoglicht, ohne die Moebel umzuraeumen Geeignet fuer alle Umgebungen und empfohlen fuer einen gewerblichen Einsatz (Bars, Restaurants, Hotels Und Terrassen) Aluminiumgestell mit anthrazitgrau Metallic-Effekt Starkes Gestell, bestehend aus 4 Sonnenschirmen, die an einem Mast verankert sind.

F
Parasol quadruple avec système innovant d'ouverture et de fermeture assisté par ressort à gaz. Structure rétractable qui permet d'ouvrir et de fermer le parasol au-dessus des tables et des chaises sans avoir à déplacer le mobilier. Convient à tous les environnements et recommandé pour un usage professionnel (bars, restaurants, collectivités, chr....). Cadre en aluminium à effet anthracite métalisée. Structure robuste composée de 4 parasols accroches à un seul mat.

E
Evolución del parasol individual astro con el nuevo sistema de apertura y cierre mediante pistón de gas. Estructura retráctil que permite abrir y cerrar el parasol por encima de las sillas y las mesas sin necesidad de apartar el mobiliario. Adecuado pata todos los ambientes y recomendado para uso profesional (bar, restaurantes, hoteles y espacios exteriores). Estructura de aluminio con efecto antracita metalizado. Estructura robusta compuesta por 4 parasoles soportados por un único palo.

NL
Evolutie van de enkele parasol astro met innovatief openings- en sluitsysteem ondersteund door een gasveer. Intrekbaar naar de mast met systeem dat openen en sluiten boven tafels en stoelen mogelijk maakt zonder het meubilair te verplaatsen. Geschikt voor alle locaties en aanbevolen voor een commerciële toepassing (bars, restaurants, hotels). Aluminium frame met antraciet metallic effect. Sterke constructie bestaande uit 4 parasols verankerd aan een enkele mast.

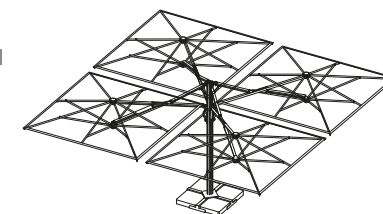



Quattro StarWhite



I
Evoluzione dell'ombrellone singolo astro con innovativo sistema di apertura e chiusura assistito tramite molla a gas. Struttura retrattile che permette apertura e chiusura al di sopra di tavoli e sedie senza dover spostare gli arredi. Adatto per tutti gli ambienti e consigliato per uso professionale (bar, ristoranti, hotel e dehor). Telaio in alluminio con verniciatura bianco starwhite opaco. Struttura robusta composta da 4 ombrelloni ancorati ad un unico sostegno.

EN
Evolution of the single parasol astro with innovative opening and closing system assisted by a gas spring. Retractable structure that allows opening and closing above tables and chairs without moving the furniture. Suitable for all environments and recommended for a commercial employ (bars, restaurants, hotels and terrace dehors). Aluminium frame with opac starwhite finish. Strong structure composed of 4 parasols anchored to a single support.

D
Entwicklung des Einzelschirmes Astro mit innovativem Oeffnungs- und Schliesssystem. Mit Unterstuetzung durch eine Gasfeder Einziehbares Gestell, das das Oeffnen und Schliessen ueber Tische und Stuehle ermoeoglicht, ohne die Moebel umzuraeumen Geeignet fuer alle Umgebungen und empfohlen fuer einen gewerblichen Einsatz (Bars, Restaurants, Hotels Und Terrassen)
Aluminiumgestell mit matt weiss Effekt Starkes Gestell, bestehend aus 4 Sonnenschirmen, die an einem Mast verankert sind.

F
Parasol quadruple avec système innovant d'ouverture et de fermeture assisté par ressort à gaz. Structure rétractable qui permet d'ouvrir et de fermer le parasol au-dessus des tables et des chaises sans avoir à déplacer le mobilier. Convient à tous les environnements et recommandé pour un usage professionnel (bars, restaurants, collectivités, chr....). Cadre en aluminium coloris blanc mat. Structure robuste composée de 4 parasols accroches à un seul mat.

E
Evolución del parasol individual astro con el nuevo sistema de apertura y cierre mediante pistón de gas. Estructura retráctil que permite abrir y cerrar el parasol por encima de las sillas y las mesas sin necesidad de apartar el mobiliario. Adecuado pata todos los ambientes y recomendado para uso profesional (bar, restaurantes, hoteles y espacios exteriores). Estructura de aluminio con pintura blanca starwhite mate. Estructura robusta compuesta por 4 parasoles soportados por un único palo.

NL
Evolutie van de enkele parasol astro met innovatief openings- en sluitsysteem ondersteund door een gasveer. Intrekbaar naar de mast met systeem dat openen en sluiten boven tafels en stoelen mogelijk maakt zonder het meubilair te verplaatsen. Geschikt voor alle locaties en aanbevolen voor een commerciële toepassing (bars, restaurants, hotels). Aluminium frame in mat wit. Sterke constructie bestaande uit 4 parasols verankerd aan een enkele mast.

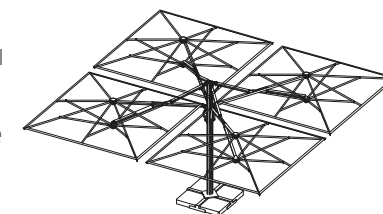

600x600





Quattro Timber



I
Evoluzione dell'ombrellone singolo astro con innovativo sistema di apertura e chiusura assistito tramite molla a gas. Struttura retrattile che permette apertura e chiusura al di sopra di tavoli e sedie senza dover spostare gli arredi. Adatto per tutti gli ambienti e consigliato per uso professionale (bar, ristoranti, hotel e dehor). Telaio in alluminio e finitura effetto legno, trattamento resistente all'acqua salata e alla degradazione uv. Effetto innovativo e molto apprezzato nel settore outdoor. Struttura robusta composta da 4 ombrelloni ancorati ad un unico sostegno.

EN
Evolution of the single parasol astro with innovative opening and closing system assisted by a gas spring. Retractable structure that allows opening and closing above tables and chairs without moving the furniture. Suitable for all environments and recommended for a commercial employ (bars, restaurants, hotels and terrace dehors). With highly durable wood finish aluminum frame. Impervious to saltwater and uv degradation. An innovative and highly appreciated effect in the outdoor branch. Strong structure composed of 4 parasols anchored to a single support.

D
Entwicklung des Einzelschirmes Astro mit innovativem Oeffnungs- und Schliesssystem. Mit Unterstuetzung durch eine Gasfeder Einziehbares Gestell, das das Oeffnen und Schliessen ueber Tische und Stuehle ermoeglicht, ohne die Moebel umzuräumen Geeignet fuer alle Umgebungen und empfohlen fuer einen gewerblichen Einsatz (Bars, Restaurants, Hotels Und Terrassen) Aluminium Gestell mit Holzeffekt. Undurchlaessig gegen Salzwasser und Uv-Degradation Innovativ und hochgeschaezt in der Outdoor-Branche. Starkes Gestell, bestehend aus 4 Sonnenschirmen, die an einem Mast verankert Sind.

F
Parasol quadruple avec système innovant d'ouverture et de fermeture assisté par ressort à gaz. Structure rétractable qui permet d'ouvrir et de fermer le parasol au-dessus des tables et des chaises sans avoir à déplacer le mobilier. Convient à tous les environnements et recommandé pour un usage professionnel (bars, restaurants, collectivites, chr....). Cadre en aluminium effet bois. Traitement résistant à l'eau salée et à la dégradation par les uv. Structure robuste composée de 4 parasols accroches à un seul mat.

E
Evolución del parasol individual astro con el nuevo sistema de apertura y cierre mediante pistón de gas. Estructura retráctil que permite abrir y cerrar el parasol por encima de las sillas y las mesas sin necesidad de apartar el mobiliario. Adecuado pata todos los ambientes y recomendado para uso profesional (bar, restaurantes, hoteles y espacios exteriores). Estructura de aluminio y acabado efecto madera con tratamiento resistente al agua salina y a la degradación por los rayos uv. Acabado novedoso y muy apreciado en el sector outdoor. Estructura robusta compuesta por 4 parasoles soportados por un único palo.

NL
Evolutie van de enkele parasol astro met innovatief openings- en sluitsysteem ondersteund door een gasveer. Intrekbaar naar de mast met systeem dat openen en sluiten boven tafels en stoelen mogelijk maakt zonder het meubilair te verplaatsen. Geschikt voor alle locaties en aanbevolen voor een commerciële toepassing (bars, restaurants, hotels). Met fraai in houtdecor afgewerkt aluminium frame. Ongevoelig voor zout water en uv-degradatie. Sterke constructie bestaande uit 4 parasols verankerd aan een enkele mast.

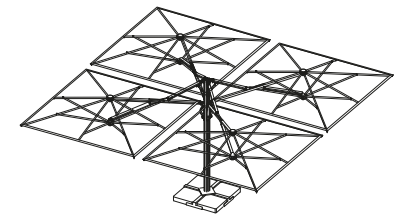

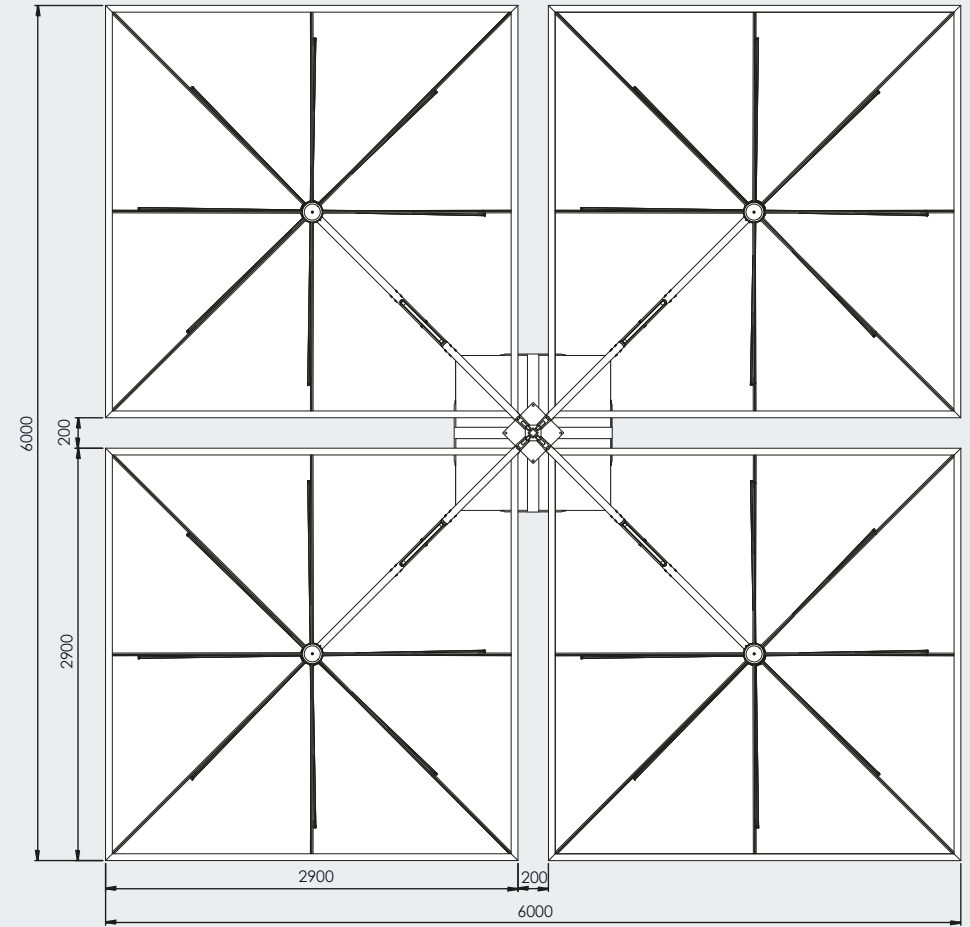

Quattro

Carbon
StarWhite
Timber

6,0x6,0





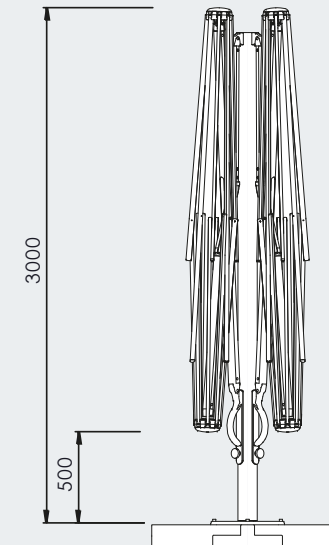
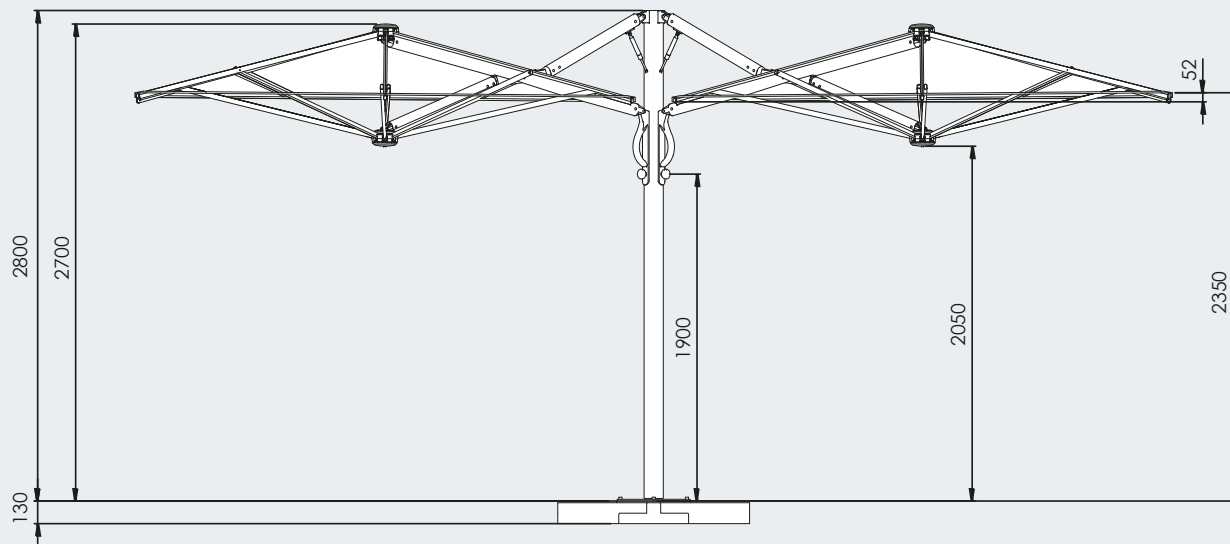

CHARACTERISTICS							FINISHING							
COD	KG	M³	Icon	Icon	Icon	Icon	Icon	Icon	Icon	Icon	Icon	Icon	Icon	INOX
CARBON C6060 QUC	170	0,80	110x110	CARBON	8	CARBON	18x30	<input type="checkbox"/>	<input type="checkbox"/>	<input type="checkbox"/>	<input type="checkbox"/>	<input type="checkbox"/>	<input type="checkbox"/>	<input type="checkbox"/>
STARWHITE C6060 QUW				STARWHITE		STARWHITE		<input checked="" type="checkbox"/>	<input checked="" type="checkbox"/>	<input checked="" type="checkbox"/>	<input checked="" type="checkbox"/>	<input checked="" type="checkbox"/>	<input checked="" type="checkbox"/>	
TIMBER C6060 QUL				TIMBER		TIMBER		<input type="checkbox"/>	<input type="checkbox"/>	<input type="checkbox"/>	<input type="checkbox"/>	<input type="checkbox"/>	<input type="checkbox"/>	

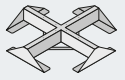
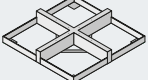

COLOUR RANGE
ACRYL 350 GR - PAG.53

A1N - T2N - T3N - T6N
T7N - T8N - T9N - S1N

OPTIONAL

	BASES - PAG.46/48		BALLAST PAG.49	GROUND FIXING - PAG.50	
					
●	PL1DS	BUD8080DS	●	BTBS	CP6565ZS
	PL1BS	BUD8080BS			
	PL1DS	BUD8080DS			

IT **IMPORTANTE!** BASE NON COMPRESA NEL PREZZO.
 UK **IMPORTANT!** BASE NOT INCLUDED IN THE PRICE.
 D **WICHTIG!** STAENDER IST NICHT IM PREIS ENTHALTEN.
 ES **IMPORTANTE!** BASE NO ESTA INCLUIDA EN EL PRECIO.
 NL **BELANGRIJK!** BASIS IS NIET INBEGREPEN IN DE PRIJS.

👁️ **PAG. 51:** VERIFICA LA STABILITÀ - CHECK STABILITY - VÉRIFIEZ LA STABILITÉ - STABILITÄT PRÜFEN
 COMPRUEBE LA ESTABILIDAD - CONTROLEER DE STABILITEIT

Optional cross metal bases



B1DS

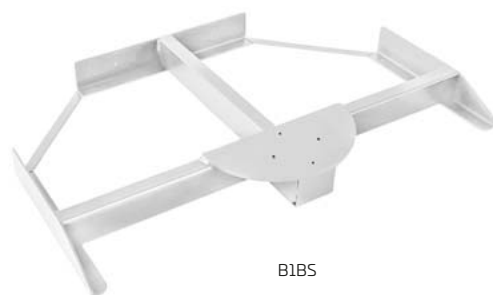

B1BS



PL1DS



PL1BS

	👁️ PAG. 49	👁️ PAG. 51
Da completare:	con zavorre	schema di stabilità
To be completed:	Available ballasts	see stability diagram
Ballast ergaenzen:	Verfuegbarer Ballast	Stabilitaetsdiagramm
A compléter avec ballasts:	Ballasts disponibles	diagramme de stabilité
Completar con losas:	Losas disponibles	diagrama de estabilidad
Aan te vullen met voorschakelapparaten:	Beschikbare ballasten	stabiliteitsdiagram

B1DS - B1BS

- Base metallica opzionale per ombrelloni a braccio laterale.
- Optional metal base for side arm parasols.
- Optionaler Metallstaender fuer Ampelschirme.
- Base en métal en option pour parasols à bras déporté.
- Base de metal opcional para sombrillas de brazos laterales.
- Optionele metalen voet voor zijarmparaplus's.



1070x710x85
mm

COD

B1DS

B1BS

KG

15 kg

PL1DS - PL1BS

- Base a croce metallica opzionale.
- Optional cross metal base.
- Optionaler Kreuz-Metallstaender.
- Base croix en métal en option.
- Base cruz de metal opcional.
- Optionele kruis metalen.



1090x1090x130
mm

COD

PL1DS

PL1BS

KG

22 kg

Carter

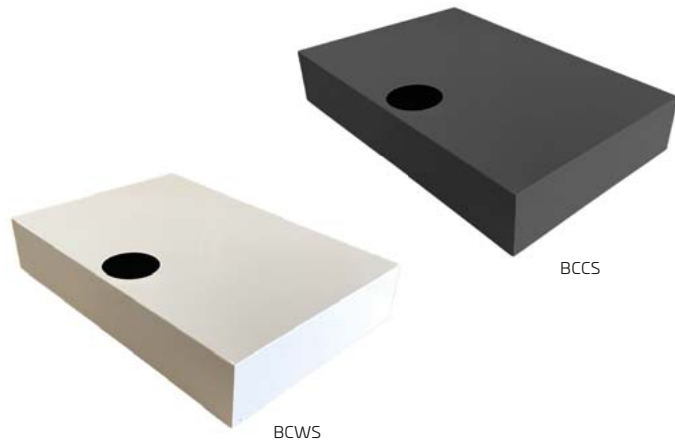

BCCS/BCWS

- Carter acciaio zincato e verniciato a polveri. Colori disponibili dark-starwhite. Compatibile con base B1DS-B1BS.
- Zincated and epoxy coated steel carter. Available colors dark-starwhite. Compatible with base B1DS-B1BS.
- Verzinkter und pulverbeschichteter Stahlcarter. Erhaeltliche Farben dark-starwhite. Kompatibel mit Staender B1DS-B1BS.
- Carter acier galvanise' et vernis. Couleurs disponibles dark-starwhite. Compatible avec socle B1DS-B1BS.
- Carter de acero galvanizado y pintado. Colores disponibles dark-starwhite. Compatible con base B1DS-B1BS.
- Gegalvaniseerd en geepoxeerde metaalcarter. Beschikbare kleuren dark-starwhite. Compatibel met basis B1DS-B1BS.

1100x720x200 mm	BCCS BCWS	18 kg

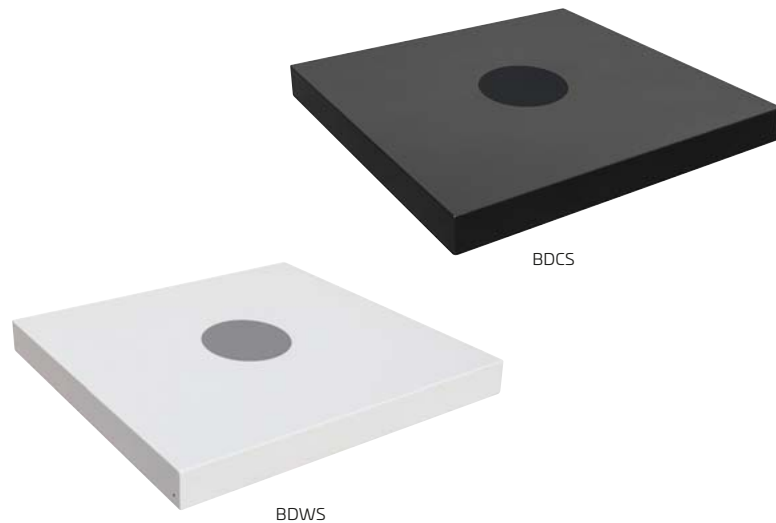

BDCS/BDWS

- Carter acciaio zincato e verniciato a polveri. Colori disponibili dark-starwhite. Compatibile con base PL1DS-PL1BS.
- Zincated and epoxy coated steel carter. Available colors dark-starwhite. Compatible with base PL1DS-PL1BS.
- Verzinkter und pulverbeschichteter Stahlcarter. Erhaeltliche Farben dark-starwhite. Kompatibel mit Staender PL1DS-PL1BS.
- Carter acier galvanisé et vernis. Couleurs disponibles dark-starwhite. Compatible avec socle PL1DS-PL1BS.
- Carter de acero galvanizado y pintado. Colores disponibles dark-starwhite. Compatible con base PL1DS-PL1BS.
- Gegalvaniseerd en geepoxeerde metaalcarter. Beschikbare kleuren dark-starwhite. Compatibel met basis PL1DS-PL1BS.

1130x1130x120 mm	BDCS BDWS	21 kg

Optional cross metal bases

BDC8080

- Carter acciaio zincato e verniciato a polveri. Colori disponibili carbon-starwhite. Compatibile con base BUD8080.
- Zined and epoxy coated steel carter. Available colors carbon-starwhite. Suitable for base BUD8080.
- Verzinkter und pulverbeschichteter Stahlcarter. Erhaeltliche Farben carbon-starwhite. Kombinierbar mit Staender BUD8080.
- Carter acier galvanisé et vernis. Couleurs disponibles carbon-starwhite. Combinable avec pied BUD8080.
- Carter de acero galvanizado y pintado. Colores disponibles carbon-starwhite. Combinable con base BUD8080.
- Gegalvaniseerd en geepoxeerde metaalcarter. Beschikbare kleuren carbon-starwhite. Combineerbaar met parasolvoet BUD8080.



890x890x140
mm

COD

BDC8080DS
BDC8080BS

KG

21 kg

BUD8080

- Base a croce metallica opzionale per ombrellone a braccio da completare con 12 BC4040, non comprese".
- Optional cross metal base for cantilever parasols to be completed with 12 BC4040, not included.
- Alternativer stahlplattenstaender fuer seitenarmschirme zum kombinieren mit 12 BC4040, nicht inbegriffen.
- Pied en acier optionnelle pour parasols bras deporté à combiner avec 12 BC4040, non inclus.
- Base de metal opcional para sombrillas brazo lateral para completar con 12 BC4040, no incluido.
- Optionele metalen basis voor arm parasol uit te voeren met 12 BC4040, niet inbegrepen.



850x850
mm

COD

BUD8080DS
BUD8080BS

KG

32 kg

B8080R

- Kit ruote alta resistenza girevoli e frenanti.
- High resistance rotating and braking wheels kit.
- Hochwiderstands-dreh- und bremsrad set.
- Kit roues rotatives et freinage haute résistance.
- Kit ruedas giratorias y frenos de alta resistenci.
- Kit met hoge weerstand draaiende en remwielen.

BDC8080BS

BDC8080DS

BUD8080BS

BUD8080DS



Ballast



BC4040 - BC5050

- Piastra in cemento e graniglia. Spessore 4 cm.
- Cement grit slab. Thickness 4 cm.
- Kiesbetonplatte. Dicke 4 cm.
- Dalles ciment et grès. Epaisseur 4 cm.
- Planchas de hormigón y de grava. De espesor 4 cm.
- Gewassen grindtegel. Gewicht 20 kg. Dikte 4 cm.



COD

KG

400X400

BC4040

14 kg

500X500

BC5050

20 kg



BC5151

- Piastra in cemento e graniglia bianca con maniglie. Spessore 11cm. Per ombrelloni a braccio.
- White cement grit slab with handles. Thickness 11cm. For cantilever parasols.
- Weisse Kiesbetonplatte mit Handgriffen. Dicke 11cm. Fuer Pendelschirme.
- Dalles ciment et grès avec poignées blanc. Epaisseur 11cm. Pour parasols avec bras deporté.
- Placas blancas de hormigón y arena con asas. De espesor 11 cm Para parasoles con voladizo.
- Wit gewassen grindtegel met handgrepen. Dikte 11 cm. Geschikt voor vrijhangende parasols.



COD

KG

500X500

BC5151

60 kg



BC5151G

- Piastra in cemento grigio con maniglie. Spessore 11cm. Per ombrelloni a braccio.
- Concrete grey cement slab with handles. Thickness 11cm. For cantilever parasols.
- Graue Betonplatte mit Handgriffen. Fuer Pendelschirme.
- Dalles ciment couleur gris avec poignées. Epaisseur 11cm. Pour parasols avec bras deporté.
- Base de cemento gris con asas. De espesor 11 cm. Para parasoles con voladizo.
- Betontegel grijs met handgrepen. Dikte 11 cm. Geschikt voor vrijhangende parasols.



COD

KG

500X500

BC5151G

60 kg



BV5050G

- Vaso in cemento grigio con maniglie. Per ombrelloni a braccio.
- Concrete grey cement pot with handles. For cantilever parasols.
- Grauer Betontopf mit Handgriffen. Fuer Pendelschirme.
- Vase ciment couleur gris avec poignées. Pour parasols avec bras deporté.
- Maceta de cemento gris con asas. Para parasoles con voladizo.
- Plantenschaal grijs beton met handgrepen. Geschikt voor vrijhangende parasols.



COD

H

KG

500x500

BV5050G

270 mm

80 kg



BV5050B

- Vaso in cemento bianco con maniglie. Per ombrelloni a braccio.
- Concrete white cement pot with handles. For cantilever parasols.
- Weisser Betontopf mit Handgriffen. Fuer Pendelschirme.
- Vase ciment couleur blanc avec poignées. Pour parasols avec bras deporté.
- Maceta de cerámica con asas de hormigón. Para parasoles con voladizo.
- Plantenschaal beton met handgrepen. Geschikt voor vrijhangende parasols.



COD

H

KG

500x500

BV5050B

270 mm

80 kg

Ground fixing



CP3030ZS

- Contropiastra acciaio zincato per fissaggio a terra. 30x30 cm.
- Small metal plate for concrete ground fixation. 30x30 cm.
- Verzinkte Stahlplatte fuer Bodenbefestigung. 30x30 cm.
- Contreplaque acier galvanise pour ancrage au sol. 30x30 cm.
- Placa acero galvanizado fijación a tierra. 30x30 cm.
- Metaal zinkplaat voor grondbevestiging. 30x30 cm.

300x300 mm	CP3030ZS	7 kg



CP6565ZS

- Contropiastra acciaio zincato per fissaggio a terra. 65x65 cm.
- Metal plate for concrete ground fixation. 65x65 cm.
- Verzinkte Stahlplatte fuer Bodenbefestigung. 65x65 cm.
- Contreplaque acier galvanise pour ancrage au sol. 65x65 cm.
- Placa acero galvanizado fijación a tierra. 65x65 cm.
- Metaal zinkplaat voor grondbevestiging. 65x65 cm.

650x650 mm	CP6565ZS	30 kg



BTAS - INGROUND FIXING ASTRO

- Supporto da interrare. Acciaio inox.
- In ground anchor. Stainless steel.
- Bodenanker. Edelstahl.
- Base pour ancrage au sol. Acier inox.
- Base para fijación a tierra. Acero inoxidable.
- Grondanker. Roestvrij staal.

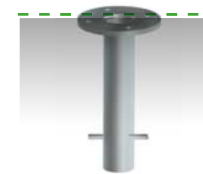

Ø 160 mm	BTAS	350 mm	5 kg



BTBS - INGROUND FIXING DUAL-QUATTRO

- Supporto da interrare. acciaio zincato.
- In ground anchor. zinced steel.
- Bodenanker. verzinktes stahl.
- Base pour ancrage au sol. acier galvanisé.
- Base para fijación a tierra. acero galvanizado.
- Grondanker. gegalvaniseerd staal.

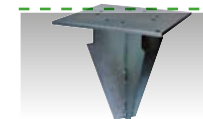

300x300 mm	BTBS	330 mm	10 kg



Stability

1 PESO MINIMO RICHIESTO
MINIMUM REQUIRED WEIGHT
ERFORDERLICHES MINDESTGEWICHT
POIDS MINIMUM REQUIS
PESO MÍNIMO REQUERIDO
MINIMAAL VEREIST GEWICHT

2 STABILITÀ INTERMEDIA
INTERMEDIATE STABILITY
MITTLERE STABILITÄT
STABILITÉ INTERMÉDIAIRE
ESTABILIDAD INTERMEDIA
GEMIDDELDE STABILITEIT

3 PESO CONSIGLIATO IN CONDIZIONI NORMALI
RECOMMENDED WEIGHT UNDER NORMAL CONDITIONS
EMPFOHLENES GEWICHT UNTER NORMALEN
BEDINGUNGEN
POIDS RECOMMANDÉ DANS DES CONDITIONS NORMALES
PESO RECOMENDADO EN CONDICIONES NORMALES
AANBEVOLEN GEWICHT ONDER NORMALE
OMSTANDIGHEDEN

4 MASSIMA STABILITÀ CON BASE
MAXIMUM STABILITY WITH BASE
MAXIMALE STABILITÄT MIT STAENDER
STABILITÉ MAXIMALE AVEC SOCLE
MÁXIMA ESTABILIDAD CON BASE
MAXIMALE STABILITEIT MET VOET

5 MASSIMA STABILITÀ CON FISSAGGIO A TERRA
MAXIMUM STABILITY WITH GROUND FIXATION
MAXIMALE STABILITÄT BEI BODENBEFESTIGUNG
STABILITÉ MAXIMALE AVEC FIXATION AU SOL
MÁXIMA ESTABILIDAD CON FIJACIÓN AL SUELO
MAXIMALE STABILITEIT DOOR BODEMBEVESTIGING

 IN CASO DI BASE CON RUOTE, PRESTARE PARTICOLARE
ATTENZIONE IN CASO DI VENTO. PRIMA DI SPOSTARE
L'OMBRELLONE È NECESSARIO CHIUDERLO.
IN CASE OF BASE WITH WHEELS, BE ESPECIALLY CAREFUL
IN WINDY CONDITIONS. CLOSE THE PARASOL BEFORE
MOVING IT.

BEI STAENDER MIT RAEDER UND WIND BESONDERS
VORSICHTIG SEIN. DER SCHIRM KANN GESCHLOSSEN
BEWEGT WERDEN.

DANS LE CAS D'UNE BASE À ROUES, FAITES
PARTICULIÈREMENT ATTENTION PAR TEMPS VENTEUX.
AVANT DE DÉPLACER LE PARASOL, IL EST NÉCESSAIRE DE
LE FERMER.

EN EL CASO DE UNA BASE CON RUEDAS, TENGA ESPECIAL
CUIDADO EN CONDICIONES DE VIENTO. ANTES DE MOVER
LA SOMBRILLA ES NECESARIO CERRARLO.

WEES VOORAL VOORZICHTIG MET STATIEVEN MET
WIELEN EN WIND. DE PARASOL KAN IN GESLOTEN
TOESTAND WORDEN VERPLAATST.

I La base e l'eventuale zavorra sono
fondamentali per garantire stabilità e
sicurezza. Selezionare l'opzione adeguata al
momento dell'ordine.

**In caso di fissaggio a terra si esclude il rischio
di ribaltamento dell'ombrellone, ma non il
cedimento strutturale di alcuni componenti
se sottoposti a condizioni atmosferiche
incompatibili con l'uso dei ns prodotti.**

Queste tabelle sono indicative e prevedono
che il pavimento o il terreno di appoggio sia
perfettamente piano e regolare. Gli ombrelloni
e i rispettivi componenti delle basi devono
essere assemblati correttamente rispettando
le istruzioni di montaggio. La stabilità degli
ombrelloni può variare nel caso di condizioni
atmosferiche particolari. L'utilizzatore finale è
responsabile del corretto uso dell'ombrellone.
Nessuna rivalsa può essere fatta sul
produttore.

UK
**The base and any ballast are essential to
ensure stability and safety. Please select the
appropriate option when ordering.**

**In case of ground fixation, the risk of
overturning of the parasol is excluded,
but not the structural failure of some
components, if subjected to atmospheric
conditions that are incompatible with the use
of our products.**

This schedule considers statics calculation and
foresees that the floor where the parasol has to
be positioned is perfectly flat and regular. The
parasols and components have to be assembled
correctly and respecting the assembly
instruction. The schedule has to be considered
indicative because many variables that depend
from the area of employ and position of the
parasols are not foreseeable. No rights can be
derived from this. The use of a parasol is always
on your own responsibility.

D
**Der Staender und eventueller Ballast sind
grundlegend um Stabilität und Sicherheit
zu gewährleisten. Bitte wählen Sie bei der
Bestellung die entsprechende Option aus.**

**Bei Bodenbefestigung ist das Risiko des
Umkippens des Schirms ausgeschlossen,
nicht jedoch das strukturelle Versagen
einiger Bestandteile, wenn sie
atmosphärischen Bedingungen ausgesetzt
werden, die mit der Verwendung unserer
Produkte nicht vereinbar sind.**

Diese Aufstellung beinhaltet statistische
Kalkulationen und sieht vor, dass der Schirm
auf einem ebenen und regelmaessigen Boden
positioniert wird.
Der Schirm und die Bestandteile des Staenders
muessen gemaess Anbauanleitungen montiert
werden. Die Stabilität der Schirme kann auf
Grund besonderer klimatischen Konditionen
aendern. Der Endbenutzer ist fuer die
ordnungsgemaesse Verwendung des Schirmes
verantwortlich.

F
**La base et les eventuels poids sont essentiels
pour assurer la stabilité et la sécurité. Svpl.
sélectionnez l'option appropriée lors de la
commande.**

**En cas de fixation au sol, le risque de
renversement du parasol est exclu, mais
pas la défaillance structurelle de certains
composants s'ils sont soumis à des
conditions atmosphériques incompatibles
avec l'utilisation de nos produits.**

Ces tableaux sont à titre indicatif et ils prévoient
que la surface sur laquelle est implanté
le parasol soit parfaitement plane et lisse.
Les parasols et les éléments respectifs des
bases doivent être assemblés en respectant
scrupuleusement les instructions de montage.
La stabilité des parasols peut varier dans le
cas de conditions atmosphériques particulières
et dépend du lieu et de l'utilisation propre à
chaque utilisateur (le parasol doit être fermé en
cas de vent fort et/ou de mauvaises conditions
météorologiques).

E
**La base y posible balasto son fundamentales
para garantizar la estabilidad y la seguridad.
Seleccione la opción adecuada al realizar el
pedido.**

**En caso de fijación al suelo, se excluye el
riesgo de vuelco del parasol, pero no el
fallo estructural de algunos componentes
si se someten a condiciones atmosféricas
incompatibles con el uso de nuestros
productos.**

Estos cuadros son indicativos y requieren que
el suelo o el apoyo de tierra sea perfectamente
plano y liso. El parasol y los respectivos
componentes de la base deben ser montados
correctamente respetando las instrucciones. La
estabilidad de los parasoles puede variar según
las condiciones atmosféricas.







NL
**Basis en eventuele ballast zijn essentieel
om stabiliteit en veiligheid te garanderen.
Selecteer alstublieft de juiste optie bij het
bestellen.**

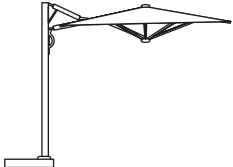



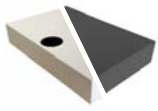





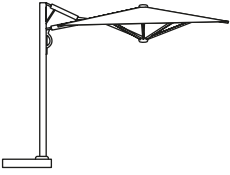

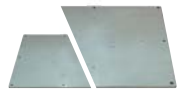

**In het geval van bevestiging aan de grond is
het risico dat de parasol omvalt uitgesloten,
maar niet het structurele falen van sommige
onderdelen als ze worden blootgesteld
aan atmosferische omstandigheden die
onverenigbaar zijn met het gebruik van onze
producten.**

This schedule considers statics calculation and
foresees that the floor where the parasol has to
be positioned is perfectly flat and regular. The
parasols and components have to be assembled
correctly and respecting the assembly
instruction. The schedule has to be considered
indicative because many variables that depend
from the area of employ and position of the
parasols are not foreseeable.

Stability



		B1				PL1				
										
		B1DS / B1BS	N° 2 BC5151 N° 6 BC5050	N° 4 BC5151 N°12 BC5050	N° 2 BV5050	BCCS / BCWS	PL1DS / PL1BS	N° 4 BC5151 N°12 BC5050	N° 4 BV5050	BDCS/BDWS
ASTRO	3,0 x 3,0	•	/	3	2	+12 BC5050	•	4	5	+12 BC5050
	3,5 x 3,5	•	/	2	1		•	3	4	
	3,0 x 4,0	•	/	2	1		•	3	4	
DUALT	3,0 x 6,0	-	/	/	/	-	•	3	4	+12 BC5050
	3,5 x 7,0	-	/	/	/		•	2	3	
DUALV	3,0 x 6,0	-	/	/	/	-	•	3	4	+12 BC5050
QUATTRO	6,0 x 6,0	-	/	/	/	-	•	2	3	+12 BC5050

BUD8080				GROUND FIXING					
 BUD8080	 + N°12 BC4040	 B8080R	 BUD8080DS BUD8080BS	 CP3030ZS	 CP6565ZS	 BTBS	 BTAS		
•	3		+12 BC4040	5	5	/	5	3,0 x 3,0	ASTRO
•	2			5	5	/	5	3,5 x 3,5	
•	2			5	5	/	5	3,0 x 4,0	
•	2		+12 BC4040	/	5	5	5	3,0 x 6,0	DUALT
•	/			/	5	5	5	3,5 x 7,0	
•	2		+12 BC4040	/	5	5	/	3,0 x 6,0	DUALV
•	1			/	5	5	/	6,0 x 6,0	QUATTRO

Fabric collection



FATTORE DI PROTEZIONE SOLARE

Limita il passaggio del calore per più del 70%.
Normativa UNI EN 410:2011

SOLAR PROTECTION FACTOR

Harmful UV rays and limiting heat circulation
Norm UNI EN 410:2011



FATTORE DI PROTEZIONE LUMINOSA

Indica la percentuale di trasmissione della luce
Normativa UNI EN 410:2011

FACTOR OF SOLAR LIGHT PROTECTION

% of light transmission
Norm UNI EN 410:2011



FATTORE DI PROTEZIONE UPF

Protezione dai raggi UV. (UPF) dal 85% al 100%
Normativa UNI EN 13758-1:2007

UPF PROTECTION FACTOR









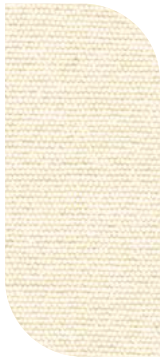

Harmful UV rays. (UPF) from 85% almost 100%
Norm UNI EN 13758-1:2007

SCHEDA TECNICA / DATA SHEET

COMPOSIZIONE / COMPOSITION	CARATTERISTICHE / FINISHING	SOLIDITÀ AL COLORE / COLOR FASTNESS	TRATTAMENTO / TREATMENT	IMPERMEABILITÀ / COLONNA D'ACQUA IMPERMEABILITY / WATER COLUMN
350 gr/m2 100% ACRYL	Inattaccabile da muffe e batteri. Solido alla luce Permeabile all'aria Antimacchia	GRADO 7/8 ENSIO 105-B04	RESINE TEFLON IDRO-OLEOREPELLENZA	CIRCA 25 CM
350 gr/m2 100% ACRYL	Resistant to mold and bacteria. Color fast. Breathable. Stain REPELLENT.	GRADE 7/8 ENSIO 105-B04	TEFLON RESIN WATER-OILREPELLENCY	ABOUT 25 CM



Fabric collection

350 GR/M² ACRYLIC									
	A1 ECRU NATURAL COL. NATUR	T2 TERRACOTTA ZIEGELROT TERRACOTTA	T3 BORDEAUX	T6 GRIGIO TAUPE GREY TAUPE GRAU TAUPE GRIS TAUPE GRIJS TAUPE	T7 BIANCO WHITE BLANC WEISS	T8 GRIGIO PERLA SILVER GREY SILBERGRAU	T9 GRIGIO ANTRACITE ANTHRACIT GREY ANTHRACITGRAU	S1 NERO / BLACK SCHWARZ NOIRE NEGRO ZWART	
		70/80%	> 90%	> 90%	> 90%	70/80%	> 90%	> 90%	> 90%
		20/30%	< 10%	< 10%	< 10%	20/30%	< 10%	< 10%	< 10%
		85/89%	100%	100%	100%	85/89%	100%	100%	100%

I dati forniti, pur essendo frutto di misurazioni scientifiche condotte in laboratori certificati, sono da ritenersi indicativi.
 The above mentioned data are indicative, although provided by scientific measurements performed in certified laboratories.

Special Fabric Collection Classe A



G596

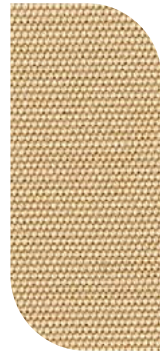

G822



R779



G013



G316



G209



G396



G245



G051

350GR/M² ACRYLIC

- Gamma tessuti a richiesta. Tessuto mano ombrellone.
- Fabric range on request. Parasol fabric.
- Farbkollektion auf Anfrage. Schirmstoffe.
- Gama de telas bajo pedido. Tejido para sombrillas.
- Kleurencollectie op aanvraag. Paraplu doek.



> 90%



< 10%



100%

Special Fabric Collection Classe B



G636



G077

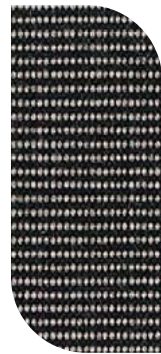

G582



G050



R777



G211



G024



R023



G285



G252



G066



G018

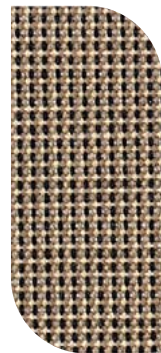

G352



G635



G055

350GR/M² ACRYLIC

- Gamma tessuti a richiesta. Tessuto mano tende.
- Fabric range on request. Awning fabrics.
- Farbkollektion auf Anfrage. Markisenstoffe.
- Gama de telas bajo pedido. Telas de toldos.
- Kleurencollectie op aanvraag. Zonweringdoek.



> 90%



< 10%



100%



Kit Led Galaxia

WHITE 3000K

- I Kit led ad alta luminosità sviluppato per le esigenze del settore professionale. Cablatura ed accessori all'interno del prodotto. Si può applicare ai modelli ASTRO, DUAL e QUATTRO. Da predisporre in fase di produzione.

Il kit è composto da:

- Circuito luminoso a led integrato nella corona centrale inferiore – per utilizzo esterno;
- Luce a led bianca 3000k con telecomando remote control (ON/OFF – dimmer);
- Batteria ricaricabile con autonomia minima di 8 ore, completa di contenitore IP56 e carica batteria;
- In alternativa alimentatore elettronico stabilizzato 220Vac - 12Vdc 60W;
- cablaggio completo per utilizzo in esterno;

- UK Complete high light LED kit developed for a professional and commercial fit. Wiring and accessories inside the product. Suitable for models ASTRO, DUAL and QUATTRO models. To be prepared during production.

The kit consists of:

- LED light circuit integrated in the lower central crown - for external use;
- 3000k white LED light with remote control remote control (ON / OFF - dimmer);
- Rechargeable battery with a minimum autonomy of 8 hours, with IP56 case and battery charger;
- Alternatively 220Vac stabilized electronic power supply - 12Vdc 60W;
- complete wiring for outdoor use;



BATTERIA / BATTERY



CARICA BATTERIA
BATTERY CHARGER



BATTERIA
BATTERY

CORRENTE / POWER



ALIMENTATORE 220V
TRANSFORMER 220V



TELECOMANDO IR
IR REMOTE CONTROL

Descrizione/Description	ASTRO	DUAL	QUATTRO
<p>- luce bianca - con collegamento elettrico</p> <p>- white light - electrical connection</p>	KIT.LED.GX.W.C	KIT.LED.GXD.W.C.	KIT.LED.GXQ.W.C.
<p>- luce bianca - kit batteria</p> <p>- white light - battery kit</p>	KIT.LED.GX.W.B	KIT.LED.GXD.W.B	KIT.LED.GXQ.W.B

Materiali e finiture

Materials and finishes

Componenti e profili alluminio

Aluminium components and profiles



TIMBER
- ASTRO
- DUALT
- DUALV
- QUATTRO



CARBON
- ASTRO
- DUALT
- DUALV
- QUATTRO



STARWHITE
- ASTRO
- DUALT
- DUALV
- QUATTRO



TITANIUM
- ASTRO

Profili stecche

Rib profiles



TIMBER
- ASTRO
- DUALT
- DUALV
- QUATTRO



CARBON
- ASTRO
- DUALT
- DUALV
- QUATTRO



STARWHITE
- ASTRO
- DUALT
- DUALV
- QUATTRO



TITANIUM
- ASTRO

Accessories



CANALINA-RAINGUTTER



COVER BAG QUATTRO/DUAL



COVER BAG ASTRO

Uso e manutenzione **AGGIORNATA**

Indicazioni

- Prima dell'uso, conservare e leggere attentamente i manuali e le istruzioni di montaggio che si trovano all'interno della confezione.
- La base deve essere zavorrata. Un peso insufficiente compromette seriamente la stabilità dell'ombrellone.
- Rimuovere sempre la manovella quando non in uso e tenerla fuori dalla portata dei bambini.
- Per evitare danni o lesioni personali, l'ombrellone deve essere chiuso e in alcune condizioni atmosferiche avverse potrebbe essere necessario rimuovere il prodotto e stoccarlo in luogo protetto. Ricorda sempre che l'ombrellone non è una costruzione fissa. La ditta Scolaro non può essere ritenuta responsabile per danni alla merce fornita, o lesioni derivanti da un uso improprio e dal mancato rispetto delle istruzioni e delle linee guida fornite.

Impiego del prodotto

Prima di iniziare ad aprire l'ombrellone, assicurarsi che il tessuto non sia rimasto impigliato nelle stecche interne. Per aprire o chiudere l'ombrellone ruotare la maniglia (dove presente) nel senso indicato dalle frecce e dalla scritta "Apri" o "Chiudi". Un funzionamento errato potrebbe strappare la corda o danneggiare il meccanismo. Non forzare mai le corde o maniglie. Se si bloccano, controlla perché è successo ed elimina la possibile causa.

Parti in legno: applicare un impregnante per legno a base di cera almeno una volta all'anno prima della stagione invernale.

Chiudere l'ombrellone quando le condizioni meteorologiche non sono adatte, ad es. forte vento o pioggia battente.

Gli ombrelloni Scolaro possono essere abbinati a basi speciali sviluppate per il fissaggio a terra. Qualora si decida di posizionare un ombrellone Scolaro utilizzando solo zavorra, ne viene certificata l'idoneità all'utilizzo in condizioni di vento moderato. Nella tabella specifica sono indicate le zavorre minime. Il Cliente è l'unico responsabile dell'installazione e della gestione dell'ombrellone.

Acciaio inossidabile

Attenzione:

1. **NON UTILIZZARE I SEGUENTI PRODOTTI** su parti in acciaio inossidabile:
Candeggina a base di cloro o detersivi contenenti candeggina (possono corrodere l'acciaio inossidabile).
Acido cloridrico o prodotti contenenti cloruri (possono corrodere l'acciaio inossidabile).

2. Il sale, il calcare o gli acidi (bevande e alimenti) possono scolorire le parti in acciaio inossidabile se non pulite tempestivamente.
3. I prodotti o le parti in acciaio inossidabile utilizzati in prossimità del mare o per la decorazione interna delle piscine richiedono una pulizia più frequente per rimuovere i cloriti depositati e per prevenire la corrosione e il deterioramento chimico delle superfici esterne.
4. Macchie o ruggine rilevate sulle superfici in acciaio inossidabile devono essere pulite tempestivamente.
5. Le macchie non rimosse per lunghi periodi possono diventare permanenti.
6. La ruggine può causare reazioni chimiche o corrodere l'acciaio inossidabile.

Per rimuovere macchie o ruggine:

- Applicare un detersivo o lucidante specifico non abrasivo per acciaio inox.
- Sciacquare accuratamente con acqua pulita.
- Infine asciugare bene per evitare che si formino striature, sfregamento nel senso delle fibre.

Metalli verniciati: Ferro e Alluminio

Per una lunga durata dell'ombrellone si consiglia di riporlo in ambienti asciutti, durante il periodo invernale e quando non utilizzato. Si consiglia inoltre di controllare una volta a stagione, soprattutto dopo un lungo periodo di inattività, il corretto funzionamento di tutti i componenti. La nostra garanzia non copre alcun tipo di graffio o abrasione alla finitura causata dal contatto con altri arredi o dalla conseguente corrosione.

L'impiego in ambienti marini può portare all'accumulo di sali e cloruri sulla verniciatura a polvere. La mancata esecuzione di una regolare pulizia con acqua dolce può causare la formazione di bolle, ossidazioni, scolorimento e invalidare la garanzia.

Per la pulizia delle superfici in metallo verniciato utilizzare acqua fredda e detersivi liquidi non abrasivi o aggressivi.

Applicare con un panno morbido. Nel caso di superfici molto sporche e/o invecchiate, dopo la pulizia, si consiglia di trattarle con paraffina liquida. In caso di macchie causate da depositi di calcare su vernici di struttura grossolana (es. ferro antico e marrone d'india) pulirle con uno straccio e una soluzione di aceto di vino bianco diluito in acqua fredda.

Legno: Iroko

Legno tradizionale impiegato per l'arredo esterno e l'industria nautica. L'iroko è un legno duro ad alto contenuto di olio, adatto per uso esterno. Estremamente duraturo. È praticamente inalterabile alla ripetuta esposizione agli agenti atmosferici. Anche se trattato, la superficie assume una patina grigio argento che è la naturale protezione dall'interno del legno, considerato parte essenziale del fascino dell'iroko. La naturale tendenza del legno ad ingrigire o perdere la brillantezza della vernice può essere prevenuta nelle prime fasi di vita del prodotto. L'ombrellone può essere ripristinato mediante un nuovo trattamento con adeguato prodotto facilmente reperibili nei negozi specializzati. È necessario applicare una soluzione di acqua e olio incolore, a superfici esposte con un panno. L'olio deve essere molto diluito. Le macchie superficiali possono essere rimosse intervenendo per tempo, prima che il legno possa assorbirle completamente. Carteggiare delicatamente la superficie in questione e poi lucidare con un panno ruvido.

Tessuti sintetici: acrilico e poliestere

Il tessuto è impermeabile e trattato antimuffa per respingere l'acqua, le macchie e garantire la traspirazione. Si prega di seguire le nostre istruzioni di manutenzione per garantire la lunga durata del tessuto:

- Rimuovere spesso depositi di polvere, macchie e qualsiasi tipo di sporco per evitare tracce dopo la pulizia.
- È molto importante chiudere l'ombrellone solo quando è perfettamente asciutto. Durante l'inverno e quando l'ombrellone non viene utilizzato, deve essere conservato in un ambiente asciutto. Evitare il contatto prolungato con sostanze oleose e/o coloranti che potrebbero essere assorbite dal materiale di rivestimento in PVC e causare macchie permanenti, oltre a danneggiare la struttura del filo. Non utilizzare solventi o detersivi a base di solventi (evitare l'acetone). Usare acqua e detersivi liquidi non abrasivi, incolore, a PH neutro. Lasciare agire il detersivo per qualche minuto. Risciacquare bene con acqua non più calda di 30°C.

Componenti

I componenti in acciaio, la viteria e gli accessori sono trattati antiruggine. Comunque per una lunga durata dell'ombrellone, durante l'inverno e quando non viene utilizzato, l'ombrellone deve essere conservato in ambiente asciutto. Durante ogni stagione è necessario verificare la funzionalità di tutti i componenti, soprattutto dopo un lungo periodo di inattività. La ditta Scolaro è a vostra disposizione per assistenza tecnica.

Garanzia **UPDATED**

Gli ombrelloni Scolaro sono progettati per durare molti anni esposti all'uso esterno.

Come per molti articoli, l'attenzione nell'uso e nella manutenzione e il rispetto delle istruzioni contenute in queste pagine, permette una vita media ancora più lunga del prodotto e la possibilità di godere di un prodotto ancora più efficiente ed esteticamente gradevole.

I prodotti Scolaro sono garantiti 2 anni.

Se si rispettano le indicazioni e i consigli, la garanzia può essere estesa come segue:

LA GARANZIA COPRE SOLO I DIFETTI DI FABBRICAZIONE DI INTEGRITÀ STRUTTURALE.

LA GARANZIA NON COPRE DANNI CAUSATI DA AZIONI MECCANICHE, FORZA NATURALE E ATTI DOLOSI.

5 anni di garanzia sui componenti in alluminio e acciaio inox. Inclusa verniciatura e viti.

- Difetti strutturali non derivanti da uso improprio o mancata manutenzione.

- Corrosione invasiva non prodotta da graffi o abrasioni da utilizzo non asportabile mediante normale pulizia e manutenzione.

5 anni di garanzia sui colori e sul trattamento dei tessuti (resistenza).

- La sostituzione della coperta durante il periodo di garanzia è prevista solo in caso di scolorimento prima della fine del periodo di garanzia. Gli utenti devono conservare correttamente i tessuti, affinché la garanzia sia effettiva. Una corretta manutenzione implica una pulizia regolare.

- La garanzia non copre i danni da contatto con oggetti estranei, abrasioni causate dal vento, uso improprio o abuso (strappi, bruciature e fori). L'uso intensivo in ambiente aggressivo (mare e piscina), richiede un regolare risciacquo del tessuto con acqua dolce per prevenire ed evitare l'accumulo di residui salini e clorurati.

2 anni di garanzia su tutti gli elementi metallici e in acciaio in genere

2 anni di garanzia in genere per le finiture e altri materiali non specificatamente menzionati e scritti sopra, comprese le basi in cemento e le zavorre

1 anno di garanzia sui kit luci LED e sui componenti elettrici in general.

LA GARANZIA NON SI APPLICA:

- Se il prodotto non è stato assemblato secondo le istruzioni fornite;
- in caso di uso improprio del prodotto o non conforme alla normale destinazione d'uso del bene;
- in caso di mancato rispetto delle istruzioni per l'uso e la manutenzione indicate nel materiale informativo fornito con il prodotto;
- in caso di stoccaggio in condizioni ambientali non idonee al prodotto;
- in caso di modifica o manomissione del prodotto;
- se il prodotto è stato assemblato o combinato con componenti e prodotti non forniti da Scolaro.

Per usufruire della garanzia è necessario esibire l'articolo difettoso o inviare le foto, unitamente alla fattura o scontrino fiscale.

La garanzia comprende la fornitura di parti di ricambio o la sostituzione del prodotto se necessario. La garanzia non comprende la riparazione in loco o il rimborso delle spese sostenute per il mancato utilizzo del prodotto.

In caso di vizio accertato da Scolaro, si riserva il diritto - a propria discrezione - di sostituire il prodotto con uno uguale o equivalente per caratteristiche essenziali o di rimborsare al cliente solo l'importo pagato per il prodotto. Nessuna ulteriore spesa o danno potranno essere richiesti a Scolaro.

Scolaro non sarà responsabile per eventuali danni a cose o persone derivanti da un uso improprio del prodotto.

Politica di servizio e riparazioni

Anche in caso di danneggiamenti e rotture, Scolaro ha sempre adottato un'attenta e puntuale politica di assistenza post vendita.

In qualunque caso di danneggiamento o necessità, consigliamo di contattare la nostra azienda per valutare la possibilità di riparare e recuperare il prodotto, nonché per ottenere assistenza per eseguire l'intervento.

La corrispondenza ad alti standard qualitativi e funzionali dei materiali impiegati costituisce la garanzia principale della robustezza e resistenza nel tempo dei prodotti Scolaro. Un comportamento rispettoso di norme di manutenzione ed uso, come specificato di seguito, assicura una durata ancora maggiore.

Le informazioni contenute in questo catalogo o in altri stampati pubblicitari della ditta Scolaro, quali caratteristiche tecniche dei prodotti o dei componenti, dimensioni, schemi di montaggio, colori, ecc., hanno valore meramente indicativo, in ragione delle specifiche tecniche e della evoluzione tecnologica dei prodotti aziendali. Al fine di migliorare la qualità del prodotto, la ditta si riserva il diritto di modificare lo stesso senza alcun preavviso e anche dopo l'accettazione dell'ordine. L'azienda si riserva di apportare modifiche parziali o totali ai prodotti senza preavviso declinando ogni responsabilità su eventuali dati inesatti. Eventuali lievi variazioni di tonalità dei colori e delle finiture rientrano nelle normali caratteristiche dei materiali impiegati. Tutte le differenze sopraindicate non sono tali da modificare significativamente i prodotti stessi e non costituiscono motivo di reso o sostituzione della merce o di contestazione.

Use and maintenance **UPDATED**

Directions

- Before use, directions and assembling instructions, which are inside the package, have to be kept and read carefully .
- The base has to be ballasted. An insufficient weight will seriously compromise the stability of the parasol.
- Always remove crank when not in use and keep out of reach of children.
- To avoid damage or personal injury, parasol must be closed and in some extreme weather conditions it may be necessary to remove the product and store it in a protected place. Remember always that the parasol is not a fixed construction.
The company Scolaro cannot be held responsible for damages to goods supplied, or injury resulting from improper use and failure to follow instruction and guidelines given on.

Product Employ

Before starting to open the parasol, make sure that the fabric has not got caught in the internal ribs. To open or close the parasol, turn the handle (where available) in the direction indicated by the arrows and the works "Open" or "Close". Incorrect operation could tear the string or damage the mechanism. Never force the ropes or handles. If they get stuck, check why this has happened and eliminate the possible cause.

Wooden parts: apply a wax-based wood-stainer at least once a year before the winter season.

Close the parasol when the weather conditions are unsuitable, strong wind or heavy rain.

Scolaro parasols can be combined with special bases developed for the ground fixing. If it is decided to position a Scolaro parasol using ballast only, their suitability for use in conditions of moderate wind is certified. In the specific table the minimum ballast weights are indicated. The Customer is the sole party responsible for installing and managing the parasol.

Stainless steel

Attention:

1. DO NOT USE THE FOLLOWING PRODUCTS on any parts made of stainless steel: Chlorine bleach or detergents containing bleach (they can corrode stainless steel).
Hydrochloric acid or products containing chlorides (they can corrode stainless steel).

2. Salt, limestone or acids (drinks and food) may discolour parts made of stainless steel if not cleaned promptly.
3. Products or parts made of stainless steel used near the seaside or for the interior decoration of swimming pools require more frequent cleaning in order to remove chlorides deposited on them and to prevent corrosion and chemical deterioration of the external surfaces.
4. Stains or rust noted on stainless steel surfaces must be cleaned promptly.
5. Stains left in place for long periods may become permanent.
6. Rust may cause chemical reactions or corrode stainless steel.

To remove stains or rust:

- Apply a specific non-abrasive detergent or polish for stainless steel.
- Rinse thoroughly with clean water.
- Lastly, dry thoroughly in order to prevent streaks from occurring, rubbing in the sense of the fibres.

Varnished metals: Iron and Aluminium

For a long lasting of the parasol we recommend to store it in dry environments, during the winter and when not in use. It's also recommended to check once a season, especially after a long period of inactivity, the proper functioning of all components. Our warranty does not cover any type of scratches or abrasions to finish caused from the contact with other furniture or any resulting corrosion.

The employ in marine environments can lead to the accumulation of salt and chlorides on the powder coating. Failure to perform regular cleaning with fresh water can cause blisters, oxidation, discoloration and invalidates the warranty.

To clean surfaces in varnished metals, use cold water and non abrasive or aggressive liquid detergents.

Apply with a soft cloth. In the case of very dirty and/or aged surfaces, after cleaning, it is advisable to treat them with liquid paraffin. In the event of stains caused by lime deposits on varnishes of coarse structure (eg. antique iron and indian brown) clean them with a cloth and a solution of white wine vinegar diluted in cold water.

Wood: Iroko

Traditional wood employed for outdoor furniture and the marine industry. Iroko is a hardwood with a high oil content, suitable for external use. Extremely long-lasting. It is practically unalterable to repeated exposure to atmospheric factors. Even if treated, the surface takes a silver-grey coating which is the natural protection from inside the wood, considered an essential part of Iroko's charm. The natural tendency of wood to turn gray or lose the brightness of the paint can be prevented in the early stages of the product life. The parasol can be restored by a new treatment with proper products easy to find in specialized shops. It's necessary to apply a solution of water and colourless oil, to exposed surfaces with a cloth. The oil must be highly diluted. Superficial stains can be removed by intervening in time, before the wood can fully absorb them. Gently sand the surface in question and then polish with a rough cloth.

Synthetic fabrics: Acryl and Polyester

The fabric is waterproof and anti mould treated to reject water, spots and grant transpiration. Please follow our maintenance instruction to grant the long lasting of the fabric:

- Remove often dust deposits, spots and any type of dirt in order to avoid trails after cleaning.
- It's very important to close the parasol only when it is perfectly dry. During the winter and when the parasol is not employed, it has to be stored in dry environment. Avoid prolonged contact with oily substances and/or dyes that could be absorbed by the covering material in PVC and cause permanent stains, in addition to damaging the structure of the thread. Do not use solvents or solvent-based detergents (avoid acetone). Use water and non-abrasive, colourless liquid detergents with a neutral PH. Let the detergent act for a few minutes. Rinse well with water no warmer than 30°C.

Components

The steel components, screws and accessories are anti rust treated. Anyway for a long lasting of the parasol, during the winter and when the it is not employed, the parasol has to be stored in dry environment. During every season it is necessary to check the functionality of all components, especially after a long period of non-employ. The company Scolaro is at your disposal for technical assistance.

Warranty **UPDATED**

Scolaro parasols are designed to last for many years exposed to outdoor use.

As with many items, attention in use and maintenance and following the instructions contained in these pages, allows an even longer average life of the product and the possibility of enjoying an even more efficient and aesthetically pleasing product.

Scolaro's products are guaranteed for 2 years.

If you comply with the indications and advices, the warranty can be extended as follows:

THE WARRANTY COVERS ONLY MANUFACTURING DEFFECTS OF STRUCTURAL INTEGRITY.

THE WARRANTY DOES NOT COVER DAMAGES CAUSED BY MECHANICAL ACTIONS, FORCE OF NATURE AND MALICIOUS ACTS.

5 years warranty on aluminum and stainless steel components. Including painting and screws.

- Structural faults not resulting from improper use or lack maintenance.
- Invasive corrosion not produced by scratches or abrasions from use not removable through normal cleaning and maintenance.

5 year warranty on colors and treatment of fabrics (strength).

- The replacement of the canopy during the warranty period is foreseen only if it loses its color before the end of the warranty period. Users must properly maintain fabrics for the warranty to be effective. Proper maintenance implies regular cleaning.
- The warranty does not cover damage from contact with foreign objects, wind-driven abrasions, misuse or abuse (tears, burns and holes). The intensive employ in an aggressive environment (seaside and pool use), requires a regular rinse of the fabric with fresh water in order to prevent and avoid the build-up of salt and chloride residues.

2 years warranty on all metal and steel elements in general

2 years warranty in general for finishes and other materials not specifically mentioned and written above, including concrete bases and ballasts.

1 year warranty on LED light kits and electrical components in general.

THE WARRANTY DOES NOT APPLY:

- If the product has not been assembled according to the instructions provided;
- in the event of improper use of the product or use that does not conform to normal intended use of the property;
- in case of non-compliance with the instructions for use and maintenance indicated in the information material supplied with the product;
- in case of storage in environmental conditions that are not suitable for the product;
- in case of modification or tampering with the product;
- if the product has been assembled or combined with components and products not provided by Scolaro.

To take advantage of the warranty the faulty item must be shown or pictures must be forwarded, together with the invoice or receipt.

The warranty includes the supply of spare parts or the replacement of the product if necessary.

The warranty does not include the repair on-site or the refund of costs incurred for non-use of the product. In case of defect confirmed by Scolaro, it reserves the right - at its own discretion - to replace the product with an equal or equivalent one for essential characteristics or to refund only the amount paid for the product to the customer.

No further expenses or damages can be requested from Scolaro. Scolaro will not be liable for any damage to properties or individuals deriving from an improper use of the product.

Service and repairs policy

Even in the event of damage and breakage, Scolaro has always adopted a careful and punctual after-sales assistance policy.

In any case of damage or need, we recommend contacting our company to evaluate the possibility of repairing and recovering the product, as well as to get assistance in carrying out the intervention.

The connection between the high qualitative and functional standards of the materials used, constitutes the main guarantee of the sturdiness and the resistance of the company's products over time. Respecting the rules of maintenance and use, specified as follows, will ensure the success of these objects, which were devised with Scolaro quality, to last a long time.

The information contained in this brochures or other Scolaro's advertisements prints, such as product specifications or components, dimensions, assembling instruction, colours, etc., are purely indicative, because of the technical specifications and the technological evolution of the company's products. In order to improve the quality of the product, the company reserves the right to change the same without prior notice and even after acceptance of the order. The company reserves the right to make partial or complete changes to the products without prior notice and declines any responsibility for inaccurate data. Any colour differences and changes of finishing have to be considered normal characteristics of the materials used. These differences do not significantly change the products and aren't reason for return or replacement of the goods or dispute.

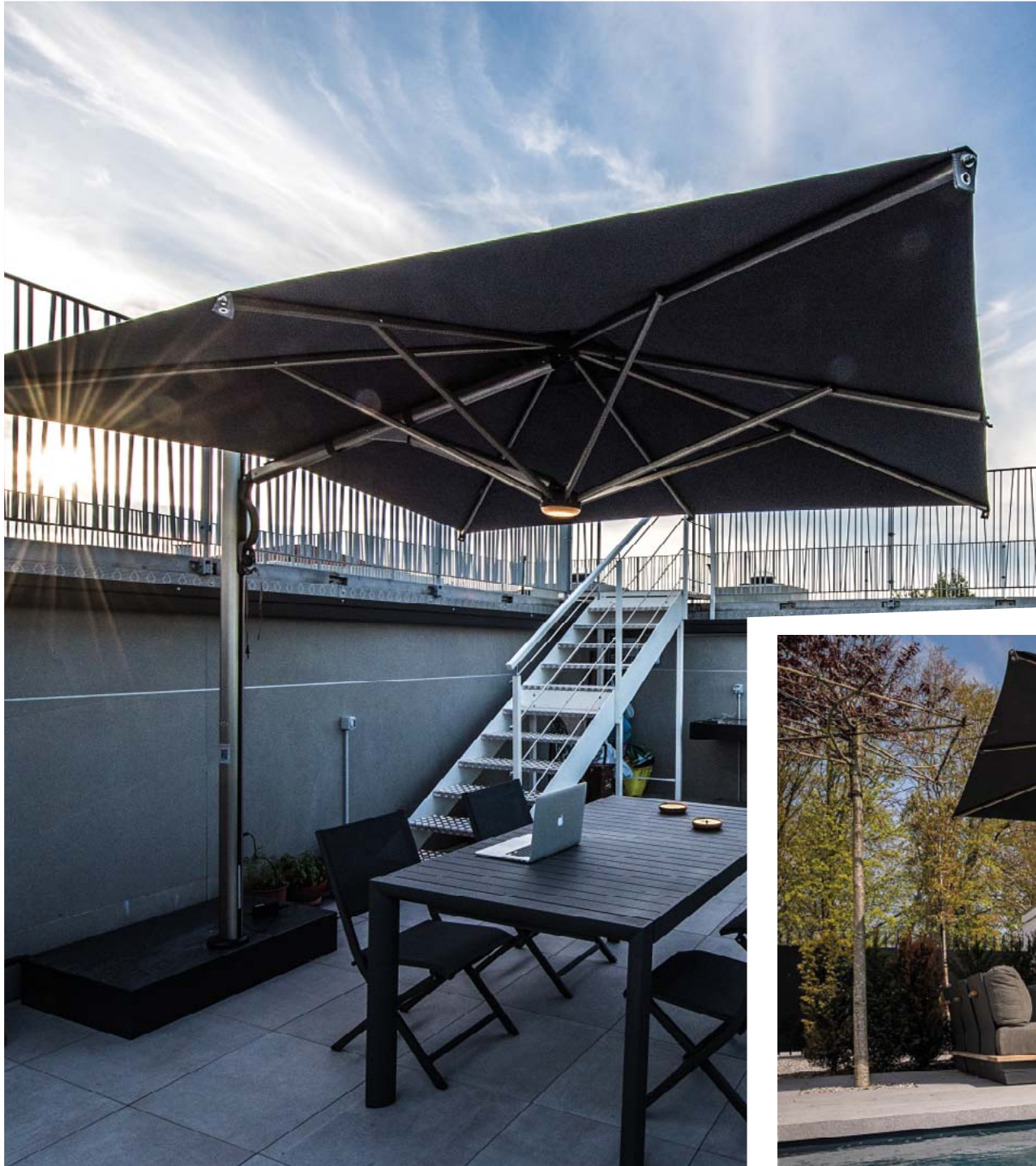

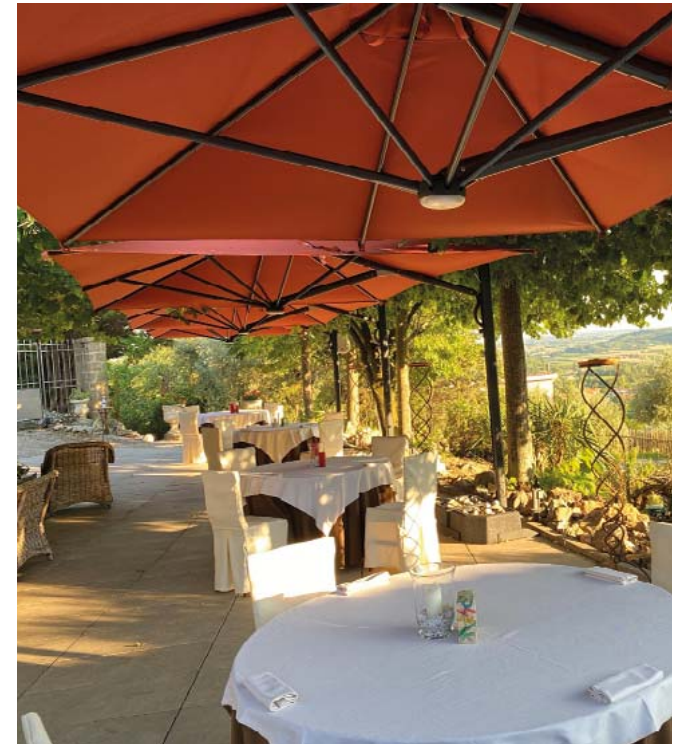







.Dimensione (metri)
 .Dimensions (meters)
 .Masse (Meter)
 .Dimensions (metrès)
 .Dimensiones (en metros)
 .Afmeting in (meters)



.Stecche
 .Ribs
 .Streben
 .Baleines
 .Varillas
 .Baleinen



.Sistema retrattile
 .Retractable system
 .Einziehbares System
 .Système retractile
 .Sistema retráctil
 .Inklapbaar systeem



.Codice
 .Code
 .Artikelcode
 .Code
 .Código
 .Artikelcode



.Set canaline
 .Raingutter set
 .Regerinnen
 .Set gouttières
 .Canalizador Lluvias
 .Set regengoten



.Piastrre cemento
 .Cement slabs
 .Kiesbetonplatten
 .Dalles ciment
 .Planchas de cemento
 .Betontegel

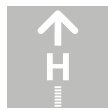

.Lunghezza
 .Length
 .Laenge
 .Longueur
 .Longitud
 .Lengte



.Con base/supporto
 .With base/support
 .Mit Staender/Huelse
 .Avec base/support
 .Con base/ soporte
 .Inclusief standaard



.Stecca con sistema "easy change"
 .Ribs with "easy change" system
 .Streben mit "easy change" System
 .Baleines avec "easy change" système
 .Varillas con sistema de " cambio fácil"
 .Baleinen met het "easy change" systeem



.Peso
 .Weight
 .Gewicht
 .Poids
 .Peso
 .Gewicht

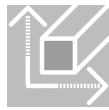

.Sezione stecche
 .Rib section
 .Strebenprofil
 .Section baleines
 .Sección varillas
 .Profiel baleinen



.Viteria in inox e ottone nichelato
 .Screws in Stainless steel and nickel plated brass
 .Edelstahlschrauben und vernickeltes Messing
 .Visserie inox et laiton nickelé
 .Tornillos en acero inoxidable y bronce niquelado
 .Schroeven van rvs en vernikkeld messing



.Volume (m3)
 .Volume (m3)
 .Volumen (m3)
 .Volume (m3)
 .Volumen (m3)
 .Volume (m3)



.Camino antiviento
 .Wind cap
 .Windfang
 .Souffle
 .Chimenea antiviento
 .Windvang



.Tipo finitura della struttura/sostegno/componenti
 .Finishing for frame/structure/components
 .Ausfuehrung des Gestells/der Struktur/der Bestandteile
 .Finition armature/structure/composants
 .Tipo de acabadó de la estructura/Soportes/Componente



.Sezione sostegno (mm)
 .Support section (mm)
 .Mastprofil (mm)
 .Section support (mm)
 .Sección soporte (mm)
 .Mast (mm)



.Fodero
 .Cover bag
 .Schutzhuelle
 .Housse
 .Forro
 .Afdekhoes

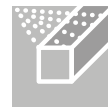

.Colore dei componenti/stecche
 .Component/Ribs colour
 .Farbe der Bestandteile und Streben
 .Couleur des composants et baleines
 .Color de los componentes ò piezas/Varillas ò listones

