

# Catalogue

Catalogo

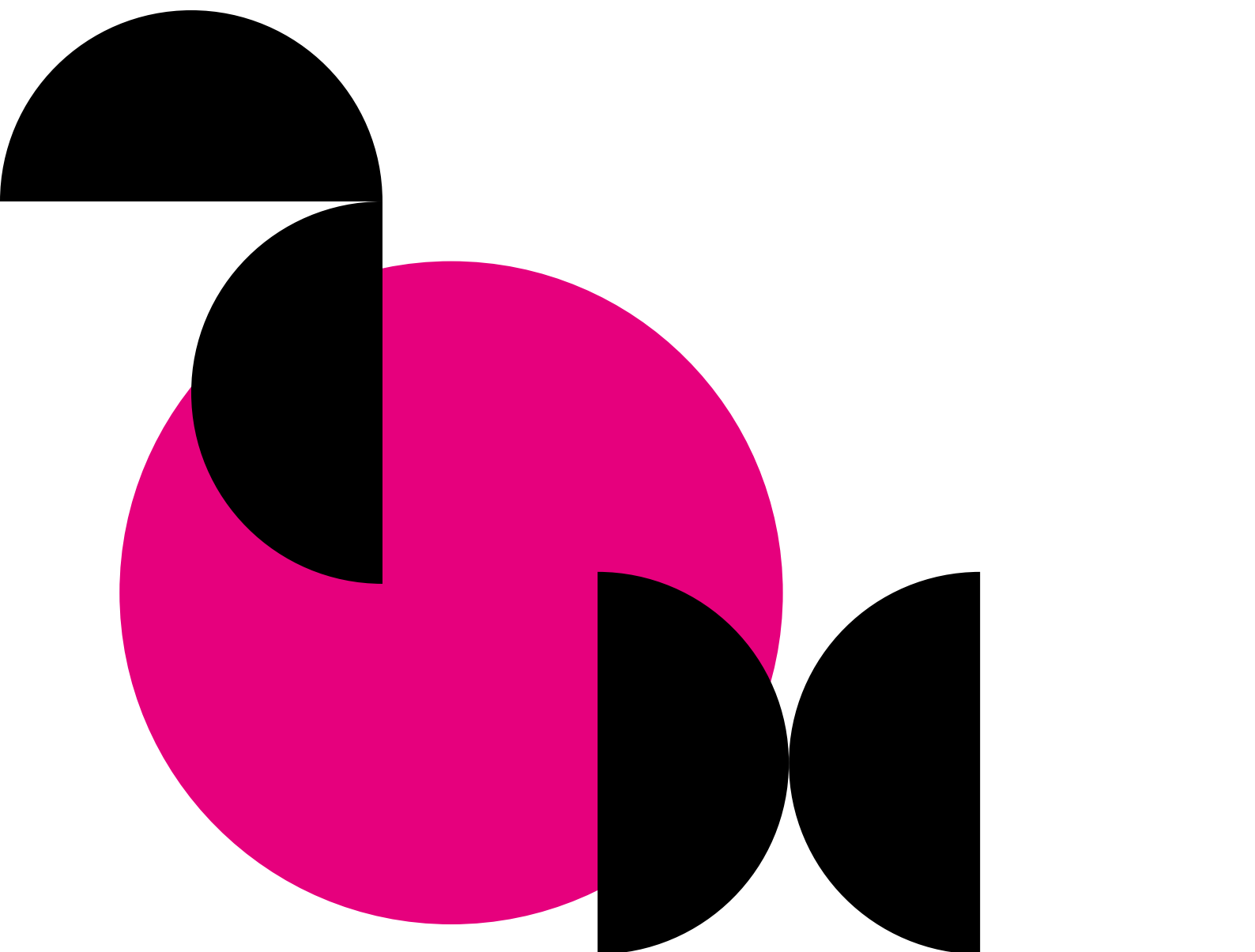

**S·CAB**

Made in Italy

**S·CAB**



**Cavalier Francesco Battaglia**  
Since 1957 S•CAB Chief  
and Managing Director

## Family

Began in 1957, S•CAB is the story of a company and a family, now extended to the third generation, born from the intuition and passion of its founder Cav. Francesco Battaglia. A brand that is known and appreciated all over the world.

*Dal 1957 S•CAB è la storia di un'azienda e di una famiglia, oggi allargata alla terza generazione, nata dall'intuito e dalla passione del suo fondatore Cav. Francesco Battaglia. Un brand apprezzato e conosciuto in tutto il mondo.*

## Logo

The original name SCAB Design is an important legacy for the family and for the furniture industry, whether it be home design or contracts, indoors or outdoors: in March 2021 we decided to renew it by creating a more contemporary and pleasant logo, where the highlighted S of 'sedute' (chairs) underlines the company's core business.

The transition from SCAB to S•CAB represents a turning point, a renewed momentum towards the future without forgetting the past, emphasizing the uniqueness of the brand.

*Il nome originario SCAB Design è un patrimonio importante per la famiglia e per il settore dell'arredamento dall'home design al contract, dall'indoor all'outdoor: nel 2021 si è deciso di rinnovarlo creando un logo più contemporaneo e gradevole, dove la S di "sedute" in evidenza sottolinea il core business dell'azienda.*

*Il passaggio da SCAB a S•CAB rappresenta un punto di svolta, un rinnovato slancio verso il futuro senza dimenticare il passato, rimarcando al tempo stesso l'unicità del brand.*

## Sustainability

Attention to the environment guides S•CAB towards cutting-edge and eco-friendly production techniques and processes to create an efficient and waste-free supply chain. Every single product reveals a tireless search for the perfection of shapes and the quality of materials, so much so that the company obtained the CATAS certification.

*L'attenzione per l'ambiente guida S•CAB verso tecniche e processi produttivi d'avanguardia ed eco-friendly per dar vita a una filiera efficiente e priva di sprechi. Da ogni singolo prodotto traspare una ricerca instancabile verso la perfezione delle forme e la qualità dei materiali, tanto da far ottenere all'azienda la certificazione CATAS.*

## 100% made in Italy

All the collections are produced in Italy in three different production facilities, spread over a total of 85,000 m<sup>2</sup>. Every technopolymer product is made internally with 30 robotic presses. In a recent past, the strong specialization in the moulding of thermoplastic materials has opened up to the use of steel, woods, and fabrics, proof of the company's commitment to responding to the demand for customization coming in particular from applications in the contract sector.

*Tutte le collezioni sono prodotte in Italia in tre diverse unità produttive, distribuite su un totale di 85.000 m<sup>2</sup>. Ciascun prodotto in tecnopolimero è realizzato internamente con 30 presse robotizzate. In un recente passato la forte specializzazione nello stampaggio di materiali termoplastici si è aperta all'uso di acciaio, legni e tessuti a riprova dell'impegno dell'azienda nel rispondere alla domanda di personalizzazione proveniente in particolare dalle applicazioni nel settore contract.*



## Design

The design of the various furnishing complements is the product of work done with passion by international architects and designers who have collaborated with the company and have managed to transform technique into art, promoting beauty with each creation.

*La progettazione dei vari complementi d'arredo è il risultato del lavoro svolto con passione da architetti e designer internazionali che hanno collaborato con l'azienda e sono riusciti a trasformare la tecnica in arte, promuovendo la bellezza in ciascuna realizzazione.*

## Awards

**Many awards and acknowledgements received in this years which testify to the excellent design and quality of products.**

*Tanti i premi e i riconoscimenti ricevuti negli anni a testimonianza dell'eccellenza progettuale e qualitativa dei prodotti.*

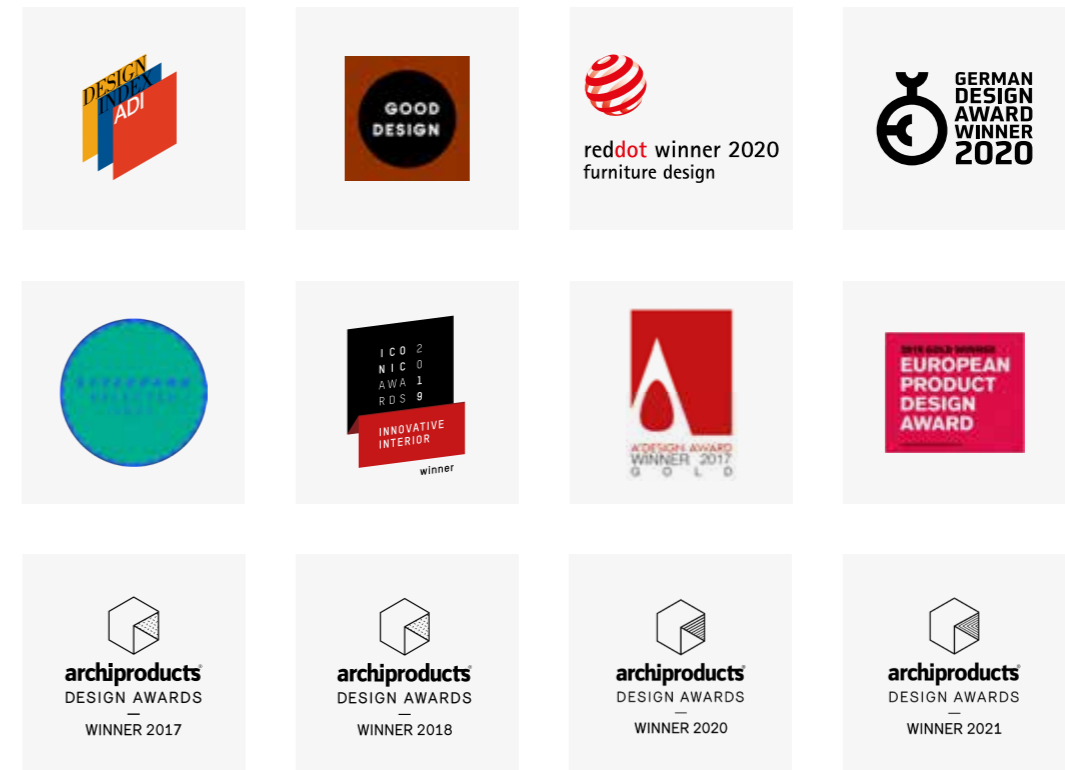



## Luisa Battaglia

After graduating with a degree in architecture from the Politecnico of Milan in 1987, Luisa Battaglia chose to go and work in the family company in 1990 when she was still very young. Since then, she has gone from working as a designer to creative director, transforming the company into a well-structured corporate business, defining the line and image of the catalogues, advertising material and trade fair stands in Italy and abroad. She became artistic director in 2018. Luisa Battaglia brings her knack for talent scouting and her intuition to choosing the designers with whom to work, guiding them every step of the way. From the brief to the development of the prototype, a constant dialogue between company and architect is called for because she is convinced that there must be coherence, first and foremost, of the idea and then, the language, respecting the designer's hallmark trait, whilst ensuring that the company's identity is not misconstrued.

*Con una laurea in architettura conseguita al Politecnico di Milano nel 1987, Luisa Battaglia entra nell'azienda di famiglia per scelta, ancora giovanissima, nel 1990. Da allora un percorso importante prima come designer e in seguito come Direttore Creativo portando l'azienda ad una ben strutturata identità corporate definendo la linea e l'immagine di cataloghi, la comunicazione pubblicitaria e gli spazi allestitivi in Italia ed all'estero. Dal 2018 è Direttore Artistico. Luisa Battaglia porta la sua sensibilità di talent scout e il suo intuito al servizio della scelta dei designer con cui collaborare guidandoli in ogni fase. Dal brief allo sviluppo del prototipo un dialogo costante azienda-architetto convinta che sia fondamentale mantenere una coerenza di linguaggio, e prima ancora di pensiero, nel rispetto del tratto distintivo del designer, perché l'identità dell'azienda non venga snaturata.*



## Arter & Citton

After graduating from the University of Architecture in Venice, Alberto Werner Arter began working as an architect and designer in Venice and Geneva, contributing to projects such as the Dupont-Nemours buildings and the underground garages in the lake of Geneva. In 1971 he was selected by the Federal Government for project tasks. In 1990 he founded, along with Fabrizio Citton, the Arter & Citton Studio and in 1997 he promoted the development and the design and contemporary arts workshop - D.MOD. Many of his projects have been selected for design and architecture exhibitions. Fabrizio Citton graduated from the University of Architecture in Venice in 1990. During that same year he founded, along with Alberto Arter, the Arter & Citton architecture and design studio. He is one of the founders in 1997 of the D.MOD design and contemporary art workshop, and became manager of its products, expositions and exhibitions. In 2000 he graduated in Contemporary History at the University of Venice Ca 'Foscari. As from 2001 he has worked on numerous architectural and design projects and products, which have been reported in numerous sector magazines and featured in various art exhibitions.

*Dopo la laurea all'Istituto Universitario di Architettura di Venezia, Alberto Werner Arter lavora come architetto e designer tra Venezia e Ginevra, contribuendo a progetti come gli edifici della Dupont-Nemours e i garage sotterranei nel lago di Ginevra. Nel 1971 è selezionato al concorso del Governo Federale per incarichi di progettazione. Nel 1990 fonda con Fabrizio Citton lo studio Arter & Citton e promuove nel 1997 lo sviluppo del laboratorio di design e arti contemporanee D.MOD. Numerosi suoi progetti sono stati selezionati in esposizioni di design e architettura. Fabrizio Citton si laurea*

*all'Istituto Universitario di Architettura di Venezia nel 1990. Nello stesso anno, fonda con Alberto Arter lo studio di architettura e design Arter & Citton. È tra i fondatori nel 1997 del laboratorio di design e arti contemporanee D.MOD, e ne diventa il responsabile dell'area prodotto, rassegne & expò. Nel 2000 si laurea in Storia Contemporanea all'Istituto universitario Cà Foscari di Venezia. Dal 2001 collabora a numerosi progetti e prodotti di architettura e design, segnalati in numerose riviste di settore e presenti in varie rassegne espositive.*



## Meneghello Paoletti Associati

Marco Paoletti and Sandro Meneghello, in addition to being product designers, are strategic consultants for industrial products. They founded Meneghello Paoletti Associati in Milan in 2007. Since then, the studio has grown and now counts a team of collaborators in addition to the founders, as well as a series of project development and communications partners. The studio has received numerous international recognitions, among which are ten Red Dot Design Awards, including one "Best of the Best", seven Design Plus Awards, three Good Design Awards, five ADI Design Index Awards, three special mentions for the German Design Awards and five mentions at Young&Design Award.

*Marco Paoletti e Sandro Meneghello, oltre ad essere product designer, si definiscono consulenti strategici per il prodotto industriale. Fondano Meneghello Paoletti Associati a Milano nel 2007. Da allora, lo studio affianca aziende italiane ed estere con il fine di creare valore aggiunto attraverso il design di prodotto. A testimonianza di questo impegno e della concretezza del suo approccio, lo studio ha ricevuto numerosi riconoscimenti internazionali, tra cui dieci Red Dot Design*

*Award di cui un "Best of the Best", sette Design Plus, tre Good Design Award, cinque ADI Design Index, tre menzioni speciali per il German Design Award e cinque menzioni allo Young&Design.*



## Simone Micheli

In 1990 he founded the Simone Micheli Architectural Studio and in 2003 the "Simone Micheli Architectural Hero" design company based in Florence, Milan and Dubai. In 2007 he represented the Italian interior design at the "XXX Congresso Colombiano de Arquitectura" in Colombia, and in 2008 at the International Conference of Architecture for the contract in Hannover, Germany.

He teaches at the Poli.Design and at the Polytechnic School of Design in Milan. In 2015, he won the International Hotel and Property Awards I European categories - hotels over 200 rooms, with his interior design and lighting project of the Barcelo Hotel Milan. In 2016, he won the Best of Houzz Award 2016 I design, for the public acclaim of his projects selected by over 35 million users of the Houzz community.

*Nel 1990 fonda l'omonimo Studio d'Architettura e nel 2003 la società di progettazione "Simone Micheli Architectural Hero" con sede a Firenze, Milano e Dubai. Nel 2007 rappresenta l'interior design italiano al "XXX Congresso Colombiano de Arquitectura" in Colombia e nel 2008 alla Conferenza Internazionale di Architettura per il contract a Hannover in Germania. È docente presso il Poli.Design e presso la Scuola Politecnica di Design di Milano. Nel 2015, con il progetto d'interior design e illuminotecnico del Barcelò Hotel Milan, vince gli International Hotel e Property Awards I European categories - Hotel over 200 rooms. Nel 2016, vince il Best of Houzz Award 2016 I design, per la popolarità dei suoi progetti selezionati dagli oltre 35 milioni di utenti delle comunità di Houzz.*



## gumdesign

Laura Fiaschi (Carrara, 1977) designer and graphics and Gabriele Pardi (Viareggio, 1966) architect, they deal with architecture, industrial design, graphics, art direction for companies and events. They have won many prizes, among which the Award Edida 2021, Adi Booth Design Award 2021 and the Premio Donna del Marmo 2019; their products were selected for exhibitions and for permanent collections in Italy and abroad. They are involved, in the University area, with open classes, workshops and they cooperate with the "Free University" of Bolzano, the Cried of Milan, the led of Florence and Rome, Pisa University and the Celsius in Lucca, the Faculty of Architecture of Genoa, the Faculty of Engineering of Trento; since 2017 they are coordinators and teachers of the first Masters in Design - Innovation and Product for High-Crafts at the IED Florence.

*Laura Fiaschi (Carrara, 1977) designer e grafica e Gabriele Pardi (Viareggio, 1966) architetto si occupano di architettura, industrial design, grafica, art direction per aziende ed eventi. Ricevono numerosi premi tra cui il premio Edida 2021, l'Adi Booth Design Award 2021 e il Premio Donna del Marmo 2019; i loro prodotti sono selezionati per mostre e collezioni permanenti in Italia e all'estero. Sono attivi nel settore universitario con lezioni aperte, workshop e collaborazioni con la Libera Università di Bolzano, il Cried di Milano, lo led di Firenze e Roma, l'Università di Pisa ed il Celsius di Lucca, la Facoltà di Architettura di Genova, la Facoltà di Ingegneria di Trento; dal 2017 sono coordinatori e docenti del primo Master in Design - Innovazione e Prodotto per l'Alto Artigianato presso lo IED Firenze.*



## Gianluca Pasotti

Gianluca Pasotti, born in 1990, is a young, eclectic, and versatile designer. After the years of training in Brescia, he graduates in interior design at the Politecnico Milano. At the ESAG in Paris, he develops a passion for the design of the great masters of the 60s, 70s, and 80s. The projects that enthuse him involve iconic objects of common use, chairs and lamps, but also offices, coordinated images, unconventional objects.

*Gianluca Pasotti, classe 1990, è un giovane designer, eclettico e versatile. Dopo gli anni della formazione bresciana, si laurea in design degli interni al Politecnico di Milano. Presso l'ESAG di Parigi matura la passione per il design dei grandi maestri degli anni '60, '70 e '80. I progetti che lo entusiasmano coinvolgono oggetti iconici di uso comune, sedie e lampade, ma anche uffici, immagini coordinate, oggetti non convenzionali.*



## Mark Robson

Born in Barnet in Hertfordshire and has lived and worked in France since 1990. He studied at Middlesex University in London and got a Masters in Furniture Design at the Royal College of Art in London. He has participated in various exhibitions for the Axis Gallery in Tokyo, the International Biennale in Belgium, the Centre Pompidou and the Salon du Meuble in France and for Superstudio Più in Milan. Samples of his works are exhibited in several museums such as the Design Museum in London and the Minneapolis Museum of Modern Art.

Nato a Barnet nell'Hertfordshire ha vissuto e lavorato in Francia dal 1990. Ha studiato alla Middlesex University di Londra e conseguito un Master in Design di Mobili al Royal College of Art di Londra. Ha partecipato a varie esposizioni per l'Axis Gallery di Tokyo, l'International Biennale in Belgio, il Centre Pompidou e il Salon du Meuble in Francia e il Superstudio Più di Milano. Esempari dei suoi lavori sono presenti in diversi musei quali il Design Museum di Londra e il Minneapolis Museum di Arte Moderna.



## RadiceOrlandini DesignStudio

Andrea Radice and Folco Orlandini, graduates at the Milan Politecnico, the first in industrial design, the second in architecture, meet after several work experiences. Since 2008 they collaborate together on the design of several highly personal and incisive style products for Italian and international companies. Andrea and Folco, guided by the idea of design intended as an emotion that combines functionality with a lasting shape. They believe in designing projects that are the synthesis of three elements: paternity, irony and improvement. Irony, understood as a constant search for what goes beyond the simple and obvious meaning of the object, has always distinguished the way of life of the two designers and hence their design approach that is always based on an improvement of what already exists, to be able to design products that are always better, from a productive, aesthetic, ergonomic, functional point of view. Among the various awards they received: in 2007 first prize in the MOV Design competition, 2010 special mention Young & Design, 2011, 2013, 2017 Good Design Award Chicago Athenaeum.

Andrea Radice e Folco Orlandini laureati al

politecnico di Milano, il primo in disegno industriale, il secondo in architettura, si incontrano dopo varie esperienze lavorative. Dal 2008 collaborano insieme alla progettazione di molteplici prodotti dallo stile fortemente personale e incisivo per aziende Italiane ed internazionali. Andrea e Folco, guidati dall'idea di design inteso come emozione che unisce alla funzionalità l'estetica che dura nel tempo, credono nell'ideazione di progetti che siano la sintesi di tre elementi: paternità, ironia e miglioramento. L'ironia, intesa come costante ricerca di ciò che va oltre il semplice ed evidente significato dell'oggetto, contraddistingue da sempre il modo di vivere dei due designer e quindi il loro approccio progettuale che tutte le volte è improntato a un miglioramento di ciò che già esiste, riuscire a ideare prodotti che siano sempre migliori dei precedenti a livello funzionale, estetico, produttivo, ergonomico. Tra i vari riconoscimenti avuti, nel 2007 primo premio al concorso MOV Design, 2010 menzione speciale Young&Design, 2011, 2013, 2017 Good Design Award Chicago Athenaeum.



## Roberto Semprini

Born in Rimini in 1959 and studied architecture in Florence. In 1989 creates the Tatlin sofa by Edra, which is among the product winners of the prestigious Top Ten Award in Dusseldorf. Since 2000 he has been living in Rimini, where he inaugurated the "RM 12 art & design", Art Gallery and the Interior Design/Architecture Studio. In 2010 he was invited by the Seoul Living Design Fair (Korea) to exhibit "The Italian/Korean house". Currently he lectures at the Academy of Fine Arts in Bologna. He is a lecturer for great fame of the Outdoor Design course at the Milan Polytechnic university. He won the Golden A' Design Award 2017 with the project of Nemo table for the company S•CAB.

Nasce a Rimini nel 1959 e studia architettura a Firenze. Nel 1989 esce il divano Tatlin di

Edra, tra i prodotti vincitori del prestigioso premio Top Ten a Dusseldorf. Dal 2000 si trasferisce a Rimini, dove inaugura "RM 12 art & design", Galleria d'arte e Studio di Design/Architettura di Interni. Nel 2010 è stato invitato dal Seoul Living Design Fair (Korea) a esporre "La casa Italo/Coreana". Attualmente è docente di ruolo presso l'Accademia di Belle Arti di Bologna. È docente incaricato per chiara fama del corso di Outdoor Design presso il Politecnico di Milano. Ha vinto il premio Gold A'Design Award 2017 con il progetto del tavolo Nemo per l'azienda S•CAB.



## Marcello Ziliani

Marcello Ziliani was born in Brescia in 1963. In 1988 he graduated in architecture at Politecnico di Milano with his thesis supervised by architect Achille Castiglioni. He devoted himself to develop projects for the design of furniture working in addition to exhibitions, theatrical scenographer, art direction, design coordination, graphics and communication. He mostly refers his attention to the aspects of sustainability and "agile producibility". Since 2011 he's a professor of product design at the University of San Marino / IUAV. He has received numerous international recognitions for the Collection Lisa produced by S•CAB.

Nato a Brescia nel 1963, Marcello Ziliani si laurea in architettura nel 1988 al Politecnico di Milano con Achille Castiglioni come relatore. Si dedica al design sviluppando progetti per i settori dell'arredamento, occupandosi inoltre di allestimenti, coreografie teatrali, art direction e comunicazione. Dedicata particolare attenzione agli aspetti della sostenibilità e della "producibilità agile". Dal 2011 insegna design di prodotto al corso di laurea in disegno industriale all'Università di San Marino/IUAV. Ha ricevuto numerosi riconoscimenti internazionali per la collezione Lisa prodotta da S•CAB.

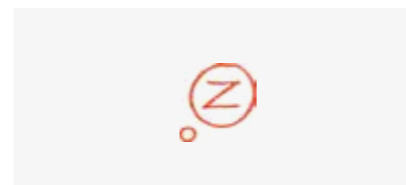

## Studio Zetass

STUDIO ZETASS, headed by Marcello Ziliani, is an integrated organisation operating in the field of product design, engineering, art direction, design coordination, graphics and installations, working with in-house or affiliated professionals who have a wide background in their specific sectors of competence. It operates at national and international level, collaborating with firms who are leaders in their respective sectors and providing consulting services for multinational groups in the sectors of furnishing, accessories, lighting, bathroom fittings, office furnishing, household objects and nursery furniture. The company's business philosophy has always been geared to the search for high quality design, based on the function and performance of the product which, independently of fashion trends, must express an intrinsic value of its own and create a lasting effect. Since 2011 he's a professor of product design at the University of San Marino/UniBo.

STUDIOZETASS, guidato da Marcello Ziliani, è una struttura integrata che si occupa di product design, engineering, art direction, design coordination, grafica e allestimenti, avvalendosi della collaborazione di professionisti, interni o collegati alla struttura, con ampio background nei settori di specifica competenza. Opera in campo nazionale ed internazionale collaborando con aziende leader nei rispettivi settori e svolgendo consulenza per gruppi multinazionali nei settori dell'arredamento, del complemento, dell'illuminazione, del bagno, dell'ufficio, dell'oggettistica e della prima infanzia. La filosofia di lavoro è da sempre improntata alla ricerca di una qualità "alta" del progettare, basata su contenuti funzionali e prestazionali del prodotto che deve esprimere, al di là delle mode, un suo valore intrinseco reale ed un contenuto formale non effimero. L'arch. Marcello Ziliani dal 2011 è docente del laboratorio di design di prodotto al corso di laurea in disegno industriale all'università di San Marino/UniBo.

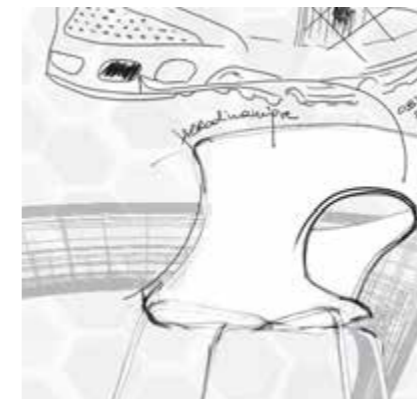

## Centro Stile S•CAB

S•CAB products are designed by a team of researchers and designers of international level which, under the creative guidance of architect Luisa Battaglia, has been able to interpret over time the needs of customers, going beyond passing fads and trends and always providing maximum quality at the most competitive price. The Design line articles are original S•CAB models, designed and made in collaboration with the CATAS tests laboratory, protected by shape patents and exclusive rights and undergo strict quality checks.

*I prodotti S•CAB sono progettati da un team di ricercatori e designer di livello internazionale che, sotto la guida creativa dell'architetto Luisa Battaglia, ha saputo interpretare nel tempo le esigenze dei clienti, spingendosi oltre le mode del momento e offrendo sempre il massimo della qualità al prezzo più competitivo. Gli articoli della linea Design sono modelli originali S•CAB, progettati e realizzati in collaborazione con il laboratorio di prove CATAS, protetti da brevetti di forma e diritti d'esclusiva e sottoposti a severi controlli di qualità.*

# Future is green

From the production process to a dedicated collection, for an increasingly green catalogue. A concrete effort to ensure a better future. S•CAB supports environmental awareness and reduces waste. This triggers a virtuous process: new plastic is not introduced into the environment and at the same time potentially polluting waste materials are recovered. From raw material to product. From product to waste. From waste to recycled material. From recycled material to new product. A continuous and perpetual reuse cycle.



Hence the GO GREEN collection, made of certified regenerated plastic (Post Consumer Industrial Plastic, or PCR): obtained from the processing and regeneration of end-of-life products (plastic bottles or food packaging), waste derived from recycling, and industrial waste (production residues). The plastic is certified as recycled and obtained thanks to the use of energy generated from renewable sources. The product will have a superior qualitative and ethical value, a characteristic that is particularly appreciated in the contract sector where resistance and durability are two key elements.



*Dal processo produttivo ad una collezione dedicata, per una proposta sempre più green. Un impegno concreto, per garantire un futuro migliore. S•CAB sostiene l'ecologia e limita lo spreco. Si innesca così un processo virtuoso: non viene introdotta nuova plastica nell'ambiente e allo stesso tempo si recuperano materiali di scarto potenzialmente inquinanti. Da materia prima a prodotto. Da prodotto a rifiuto. Da rifiuto a materia riciclata. Da materia riciclata a nuovo prodotto. Un ciclo continuo e perpetuo di riuso.*

*Da qui nasce la collezione GO GREEN, realizzata in plastica certificata rigenerata (post consumo industriale PCR): ottenuta dalla lavorazione e rigenerazione di prodotti giunti a fine vita (bottiglie di plastica o imballaggi alimentari), scarti derivati dalla raccolta differenziata e scarti industriali (residui di produzione). La plastica è certificata come riciclata e ottenuta grazie all'utilizzo di energia generata da fonti rinnovabili. Il prodotto avrà un valore qualitativo ed etico superiore, condizione particolarmente apprezzata nel contract dove resistenza e durata sono due degli elementi chiave.*



## sustainability

Designing today means drawing a sustainable tomorrow by taking action in all company areas to reduce waste and ensure that every process pursues this goal, which has become a concrete commitment. A perpetual dialogue between principles, evaluations, and solutions to produce and live responsibly. Thus, every single S•CAB product component is easy to disassemble and dispose of. Each plastic element bears the identification mark according to ISO 11469:2001 and provides simple instructions for its recycling. High performance and high-quality standards are safely guaranteed by processes and production.

**Nautical rope.** 100% recyclable polyester, dope-dyed, non-toxic, resistant and easy to maintain.

**Corda nautica.** 100% poliestere riciclabile, tinto in pasta, atossico, resistente e di facile manutenzione.



**Regenerated plastic.** New plastic is not introduced into the environment and at the same time potentially polluting waste materials are recovered.

**Plastica certificata rigenerata.** Non viene introdotta nuova plastica nell'ambiente e allo stesso tempo si recuperano materiali di scarto potenzialmente inquinanti.



Progettare oggi significa disegnare un domani ecosostenibile intervenendo in tutti gli ambiti aziendali per ridurre gli sprechi e far sì che ogni processo persegua questo obiettivo diventato impegno concreto. Un dialogo perpetuo tra principi, valutazioni e soluzioni per un produrre e vivere responsabile. Così ogni singolo componente di prodotto S•CAB è facile da smontare e smaltire. Ogni elemento plastico riporta il marchio d'identificazione secondo la normativa ISO 11469:2001 e fornisce semplici indicazioni per il suo riciclaggio. Elevate prestazioni e alti standard qualitativi vengono garantiti in sicurezza dalle procedure e nella produzione.



**FSC® certified article.** The product is manufactured with wood supplied with origin certification from well and responsibly managed forests.

**Prodotto certificato FSC®** realizzato con legno certificato proveniente da foreste gestite in modo corretto e responsabile.

FSC® certification mark guarantees that the whole wood-paper chain, which is compliant with its standards, derives from an environmentally respectful forest management, socially useful and economically sustainable. Ask for our FSC® certified products.

Il marchio di certificazione FSC® garantisce che l'intera filiera legno-carta certificata per i suoi standard derivi da una gestione forestale rispettosa dell'ambiente, socialmente utile ed economicamente sostenibile. Richiedi i nostri prodotti certificati FSC®.

Recycled and 100% sustainable natural cork, it can be used both indoors and outdoors, with the same cleaning and maintenance precautions valid for wood.

**Sughero naturale riciclato e 100% ecologico,** si può usare sia all'interno che all'esterno, con le stesse accortezze di pulizia e manutenzione valide per il legno.



# Index

## A-K

DRESS\_CODE<sup>22</sup>

Emi<sup>186</sup>

Finn<sup>102</sup>

Ginevra<sup>182</sup>

Hug<sup>34</sup>

Kate<sup>184</sup>

## L

Lady B<sup>136</sup>

Lisa<sup>118</sup>

Lisa Club<sup>64</sup>

Lisa Filò<sup>56</sup>

Lisa Sofa<sup>50-60</sup>

Lisa Lounge<sup>54-62</sup>

Lisa Swing<sup>68</sup>

## M-R

Metropolis<sup>164</sup>

Nemo<sup>174</sup>

Pranzo Allungabile<sup>148</sup>

Rhino<sup>172</sup>

## S

Si-Si<sup>90</sup>

Squid<sup>72</sup>

Squid Allungabile<sup>44</sup>

Summer<sup>176</sup>

Sunset<sup>188</sup>

## T

Tiffany<sup>166</sup>

Trick<sup>98</sup>

Tripé<sup>110</sup>

## U-Z

Vela<sup>190</sup>

Zebra<sup>154</sup>

**Good design  
is a language,  
not a style.**

*Il buon design è un linguaggio, non uno stile.*

**DRESS\_CODE<sup>22</sup>, Hug<sup>34</sup>, Squid Allungabile<sup>44</sup>**

# DRESS\_CODE

design **gumdesign**

**DRESS\_CODE FASHION** — 2584 VT A3 C8  
*lounge indoor*



The new **DRESS\_CODE** armchair is inspired by the canons of haute couture, playing with the combinations of colours between structure and seat, with the indoor and outdoor fabrics patterns, and with their upholstery: in addition to the smooth and flat fabric version, there is a quilted version in big squares, and a padded, wave-shaped version. The quilting and padding are both an aesthetic element and a source of greater comfort.

*La nuova seduta **DRESS\_CODE** si ispira ai canoni della moda sartoriale, giocando con gli abbinamenti di colori, tra struttura e seduta, con le trame dei tessuti per indoor ed outdoor e con la loro lavorazione: oltre al tessuto liscio come un foglio, vengono proposti una versione trapuntata a quadrotti, ed una imbottita e sagomata ad onde. Le trapuntature e le imbottiture sono sia un elemento grafico che fonte di maggiore comfort.*



**DRESS\_CODE GLAM** — 2582 VO S7 C6  
*lounge indoor*

**DRESS\_CODE Coffee Table** — 2743 VO VO  
table 41x41 cm



**DRESS\_CODE GLAM** — 2583 VT A4 C9  
*lounge outdoor*

**DRESS\_CODE SMART** — 2581 VE A3 C8  
*lounge outdoor*

**S•CAB**

**DRESS\_CODE GLAM** — 2582 VO S6 C5  
*lounge indoor*

**DRESS\_CODE FASHION** — 2584 VA A5 D0  
*lounge indoor*

# indoor



**DRESS\_CODE GLAM** — 2582 VT S6 C5  
lounge indoor

**DRESS\_CODE GLAM** — 2582 VA A3 C8  
lounge indoor



**DRESS\_CODE SMART** — 2580 VD S7 C6  
lounge indoor

S•CAB

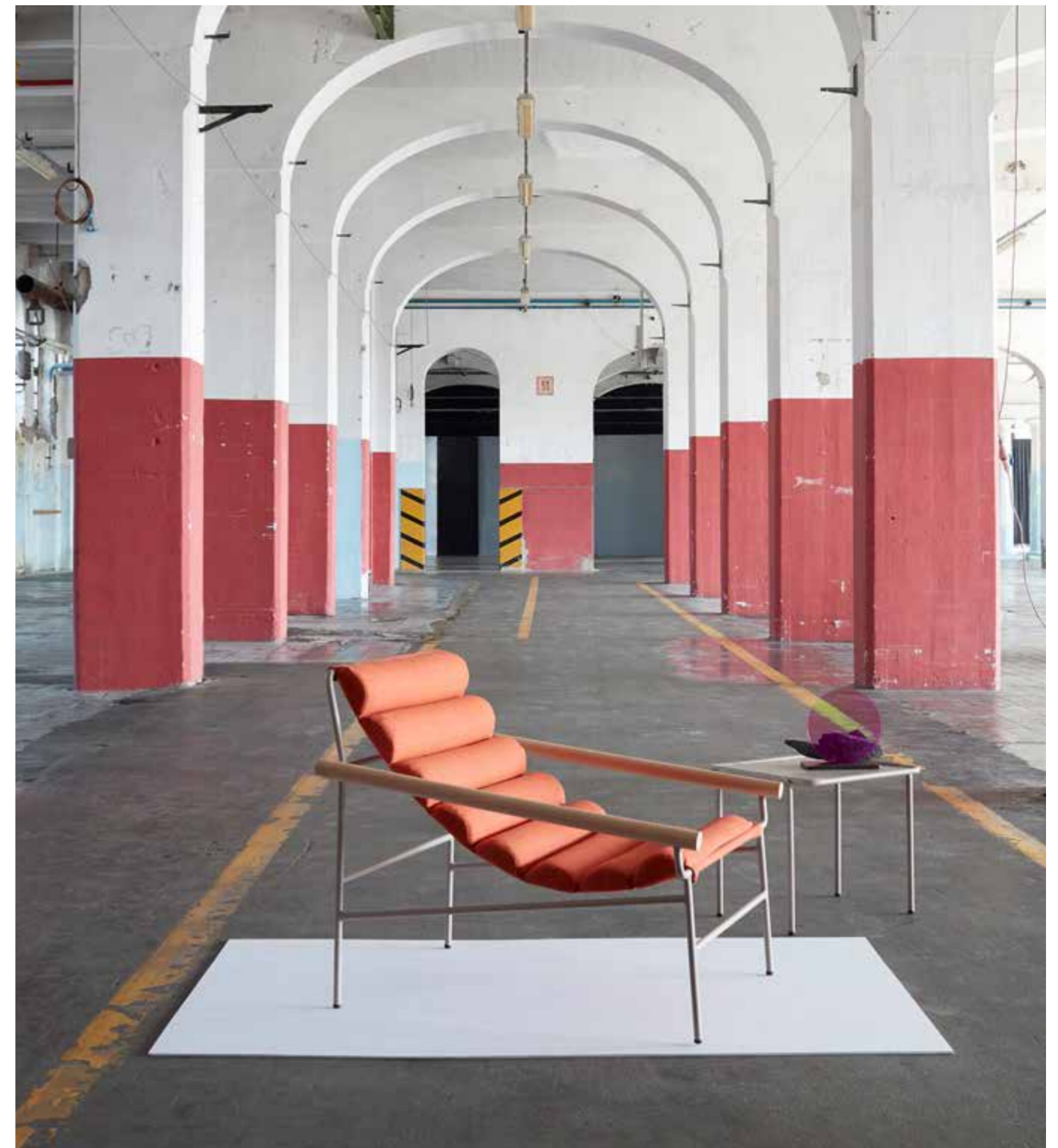

DRESS\_CODE has a metal frame available in the colours: linen, dove grey, anthracite, terracotta, air force blue, and olive green. In the indoor version the armrest is in FSC-certified oak wood.

**DRESS\_CODE Coffee Table** — 2743 VT VT  
table 41x41 cm

*DRESS\_CODE ha telaio in metallo disponibile nelle nuance lino, tortora, antracite, terracotta, avio e verde oliva. In versione indoor il bracciolo è in legno di rovere certificato FSC.*

**DRESS\_CODE FASHION** — 2584 VT A4 C9  
lounge indoor



**DRESS\_CODE GLAM** — 2583 VE S6 C5  
lounge outdoor

**DRESS\_CODE SMART** — 2581 VO S6 C5  
lounge outdoor

S•CAB

# outdoor

DRESS\_CODE has a metal frame available in the colours: linen, dove grey, anthracite, terracotta, air force blue, and olive green. In the outdoor version, the armrest is in FSC-certified iroko wood, or in metal colour-coordinated with the frame.

*DRESS\_CODE ha telaio in metallo disponibile nelle nuance lino, tortora, antracite, terracotta, avio e verde oliva. In versione outdoor il bracciolo è in legno di iroko certificato FSC, oppure in metallo in tinta coordinata al telaio.*



**DRESS\_CODE BASIC** — 2585 VE T73  
lounge outdoor



fabric detail: S7 C6  
dettaglio tessuto

**DRESS\_CODE GLAM** — 2583 VO A5 D0  
lounge outdoor

# DRESS\_CODE

## Coffee Table



**DRESS\_CODE Coffee Table** — 2743 VO VO - 2742 VD VD - 2744 VE SN  
table 41x41 cm - ø 45 cm - 36x77 cm

Three coffee tables, to be used individually or in combination with the chairs, symbolize with their shapes continuity, cyclicity, and therefore the relationship with time, seasons, everyday life, space. The green soul of the tables is expressed in the black cork top, a completely eco-friendly, natural, and recycled material, perfect for both outdoor and indoor spaces.

*Tre coffee table, da usare abbinati o singolarmente, simboleggiano con le loro forme la continuità, la ciclicità e quindi il rapporto con il tempo, le stagioni, il quotidiano, lo spazio. L'anima green dei tavolini si esprime nel piano in black cork, un materiale completamente ecologico, naturale e riciclato, perfetto sia per gli spazi esterni che per quelli indoor.*

**DRESS\_CODE Coffee Table** — 2743 VT VT - 2744 VE VE  
table 41x41 cm - 33x77 cm



**DRESS\_CODE Coffee Table** — 2742 VD VD - 2743 VT VT  
table ø 45 cm - 41x41 cm



**DRESS\_CODE Coffee Table** — 2743 VO SN - 2742 VD SN  
table 41x41 cm - ø 45 cm



# DRESS\_CODE

## finishes chart

Abaco finiture DRESS\_CODE



### Sunbrella® Fabrics

Tessuti Sunbrella®

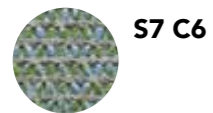

### Fabrics

Tessuti



### Serge Ferrari Breathable Fabrics

Tessuti traspiranti Serge Ferrari



### Armrest finishes

Finiture braccioli

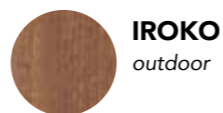
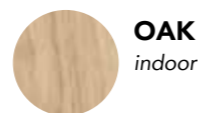

### Metal finishes

Finiture metallo



### HPL finishes

Finiture HPL



### Cork finishes

Finiture sughero



# Hug

design **Meneghello Paoletti Associati**

**Chair Hug** — 2380 58  
sedia



**The new HUG chair collection is made entirely from second-life materials. The organic shapes, creatively green, support relaxation thanks to the rounded lines and the original element of the band, defined by a relieved striped pattern, which envelops just like a hug. There are two variants: an all-technopolymer version, perfect for outdoor environments, and a softer one with the addition of a seat cushion and padded band covered in fabric, even more enveloping.**

go  
green

*La nuova collezione di sedute HUG è realizzata al 100% con materiali al secondo ciclo di vita. Le forme organiche, creativamente green, assecondano il relax grazie alle linee arrotondate e all'elemento originale della fascia, definita da un motivo a righe in rilievo all-over, che avvolge proprio come un abbraccio. Due sono le varianti: una versione tutta in tecnopolimero, perfetta per l'outdoor, un'altra più aggraziata con l'aggiunta di cuscino di seduta e fascia imbottita e rivestita in tessuto, ancora più avvolgente.*



**Armchair Hug** — 2384 56 A6 89  
poltrona

**Armchair Hug** — 2382 58  
poltrona



**Armchair Hug** — 2382 15  
*poltrona*

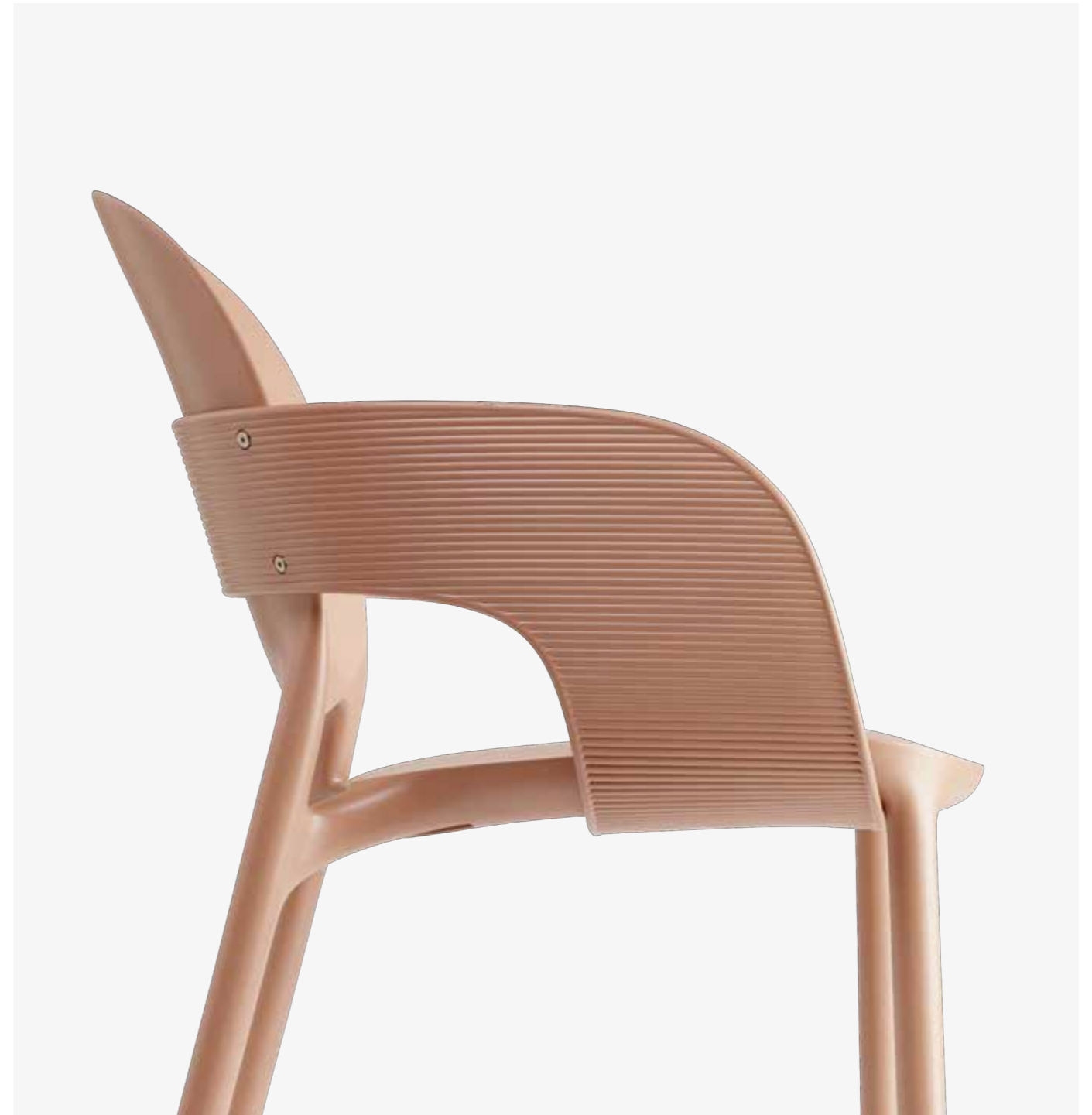

**Armchair Hug** — 2382 17  
*poltrona*



**Chair Hug** — 2381 15 L1 D4  
*sedia*

**Armchair Hug** — 2382 58  
*poltrona*

**Chair Hug** — 2380 17  
*sedia*

**S•CAB**

**Armchair Hug** — 2384 17 T9 E2  
*poltrona*

**Chair Hug** — 2382 56  
*sedia*



**Armchair Hug** — 2384 58 A6 89  
*poltrona*



**Armchair Hug** — 2383 56 L1 D4  
*poltrona*



**Chair Hug** — 2381 17 L1 D4  
*sedia*

# Hug

## finishes chart

Abaco finiture Hug

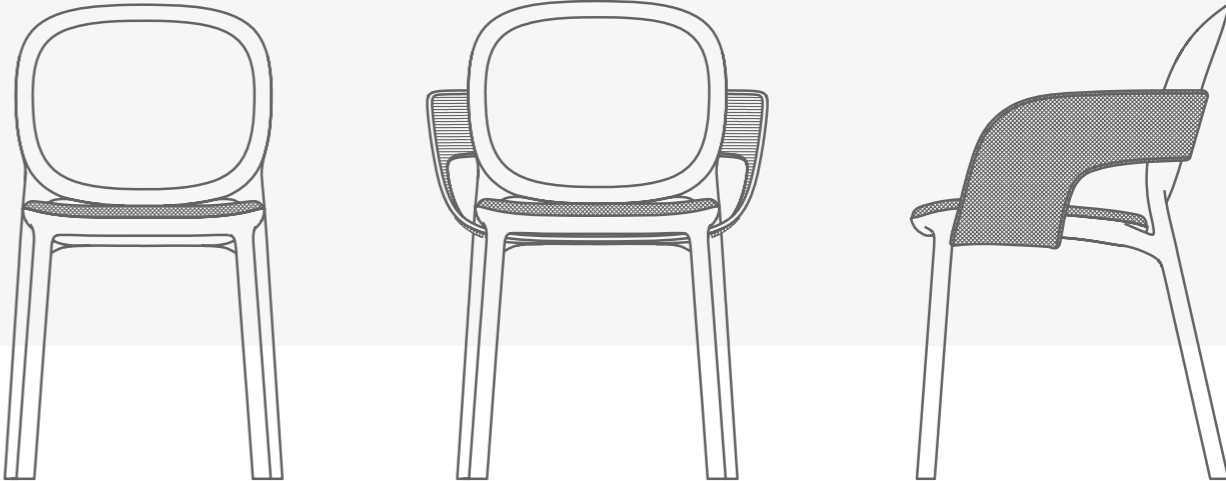
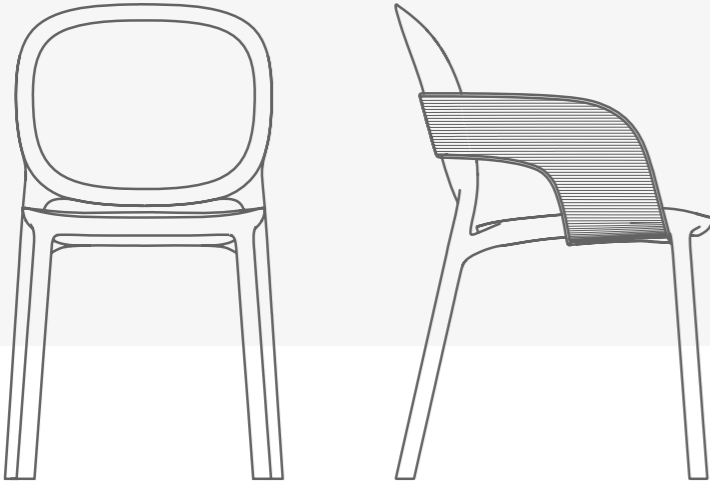

**Post Consumer Industrial Technopolymer**  
*Tecnopolimero da post consumo industriale*

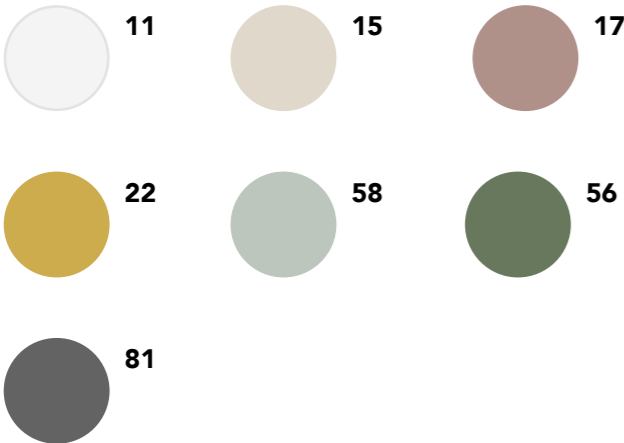

**Acrylic - A6**  
*Acrilico*

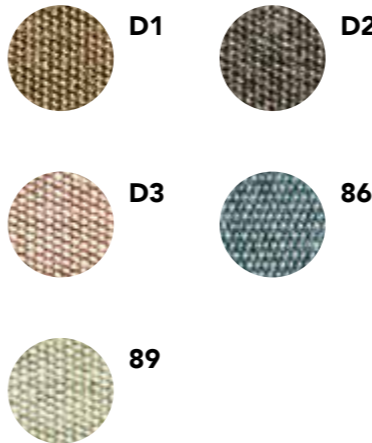

**Linen - L1**  
*Lino*

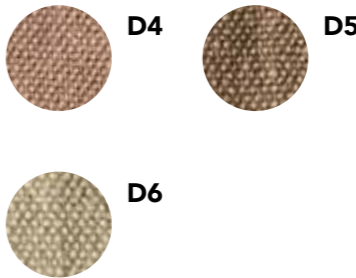

**Fabrics - T9**  
*Tessuti*



# Extendable Squid

design **RadiceOrlandini DesignStudio**

**Squid Allungabile 210/250/290** — 2439 VN 94  
extendable table

**The latest addition to the now iconic Squid collection is the extendable version, which makes the table even more flexible and customizable. The approach to the project by the designer duo was not only aesthetic: their thinking was indeed centred on productivity and composition even before form. Easy to handle, Extendable Squid gives life to a versatile product suitable for any environment and occasion.**

*L'ultima novità per l'ormai iconica collezione Squid è la versione allungabile, che rende il tavolo ancora più flessibile e personalizzabile a seconda delle esigenze. L'approccio al progetto da parte del duo di designer non è stato unicamente estetico: il loro pensiero è stato anzi di tipo produttivo e compositivo prima ancora che formale. Semplice da gestire, Squid allungabile dà vita a un prodotto versatile e adatto ad ogni ambiente e occasione.*



**Extendable Squid is available with a dove-grey spatula, slate, or concrete effect top.**

*Squid Allungabile è disponibile con piano effetto spatolato tortora, ardesia o effetto cemento.*



**Armchair Si-Si** — 2502 ZE  
*poltrona*

**Chair Si-Si Dots** — 2505 ZE  
*sedia*

**S•CAB**

**Squid Allungabile 210/250/290** — 2439 VE 92  
*extendable table*



**Style is an  
expression  
of imagination.**

*Lo stile è espressione dell'immaginazione.*

**Lisa Sofa Filò<sup>50</sup>, Lisa Lounge Filò<sup>54</sup>, Lisa Filò<sup>56</sup>,  
Lisa Sofa Club<sup>60</sup>, Lisa Lounge Club<sup>62</sup>, Lisa Club<sup>64</sup>,  
Lisa Swing<sup>68</sup>, Squid<sup>72</sup>, Squid M<sup>80</sup>, Squid OF<sup>82</sup>**

# Lisa Sofa Filò

design **Marcello Ziliani**

**Lisa Sofa Filò** — 2884 ZL N57 XV  
divano



**Lisa Sofa Filò, the new outdoor sofa from the Lisa collection, evokes and complies with our natural desires for relaxation, pampering and comfort. The interweaving of the nautical rope backrest conveys personality, warmth and a “family feeling”, while the fresh and vibrant color range is a hymn to Summer, making us feel even more part of the nature.**

*Lisa Sofa Filò, il nuovo divano per esterni della collezione Lisa, evoca e asseconda i nostri naturali desideri di relax, coccole e confort. L'intreccio dello schienale in corda nautica conferisce personalità, calore e “family feeling”, mentre la gamma cromatica fresca e vibrante è un inno ai colori estivi, per farci sentire ancor più parte della natura che ci circonda.*



**Lisa Sofa Filò** — 2884 ZL N57 XV  
divano

**Armchair Lisa Lounge Filò** — 2878 ZL N57 XH  
poltrona

**Side Table Lisa Lounge** — 2879 ZL ZL  
side table



**Cushions Sunbrella® fabric**  
Cuscini tessuto Sunbrella®

**Armchair Lisa Lounge Filò** — 2878 ZL N84  
poltrona

**Lisa Sofa Filò** — 2884 ZL N84 XH  
divano

**Side Table Lisa Lounge** — 2879 ZL ZL  
side table

# Lisa Lounge Filò

design **Marcello Ziliani**

**Armchair Lisa Lounge Filò — 2878 ZA N81**  
poltrona



**Expertly woven in nautical rope, it was created to complete the Lisa Filò collection. To create a cosy and relaxed atmosphere, you can combine it with Tripé: iconic and versatile side table suitable for all settings.**

*Sapientemente intrecciata a mano in corda nautica italiana, nasce come completamento della collezione Lisa Filò.*

*Per creare un'atmosfera accogliente e rilassata è possibile abbinarla con Tripé, tavolino iconico e versatile adatto a tutti gli ambienti.*



**Armchair Lisa Lounge Filò — 2878 ZA N57**  
poltrona

**Base Tripé Maxi h. 50 — 5009 VA**  
basamento

# Lisa Filò

design **Marcello Ziliani**

**Armchair Lisa Filò** — 2869 ZL N84  
*poltrona*



**The nautical rope makes it an ideal furniture complement to enjoy summer and outdoor life. The five structure/colour variants create charming chromatic weaves.**

*La fettuccia di corda nautica la rende un complemento d'arredo ideale per godersi l'estate e la vita all'aria aperta. Le cinque varianti struttura/colore creano suggestivi intrecci cromatici.*



**Barstool Lisa Filò h.75** — 2871 ZL N57  
*sgabello*



**Armchair Lisa Filò** — 2869 ZA N80  
poltrona



**Base Nemo** — 5060 AV 15  
basamento

**Chair Lisa Filò** — 2870 ZT N30  
sedia

# Lisa Sofa Club

**Armchair Lisa Lounge Club** — 2877 ZE P73  
*poltrona*

**Lisa Sofa Club** — 2885 ZE P73 XT  
*divano*

**Side Table Lisa Lounge** — 2879 ZE ZE  
*side table*

**Sturdy and elegant, the Lisa Sofa Club outdoor sofa is designed to satisfy the desire for comfort and relaxation. The weave of the backrest in extruded PVC, combined with the solidity of the metal frame, gives it personality and warmth; the generous cushions in bright colours welcome us softly, to feel even closer to nature.**

*Robusto ed elegante, il divano da esterni Lisa Sofa Club è studiato per soddisfare il desiderio di comfort e relax. L'intreccio dello schienale in estruso di PVC, unito alla solidità del telaio metallico, gli conferisce personalità e calore, i generosi cuscini dai colori accesi ci accolgono morbidamente. Per sentirsi ancora più parte della natura.*



# Lisa Lounge Club

design **Marcello Ziliani**

**Armchair Lisa Lounge Club — 2877 ZE P73**  
poltrona



**Ideal for relaxing, the seat and backrest are made from interweaved PVC bands. The play of colours between the structure and the frame makes it an airy, cheerful, elegant and informal complement.**

*Ideale per rilassarsi, seduta e schienale sono il risultato di un intreccio di nastri in PVC. Si presta a ricercati giochi di colori tra struttura e telaio che la rendono un complemento dai tratti ariosi e spensierati, eleganti e informali.*



**Armchair Lisa Lounge Club — 2877 ZE P74**  
poltrona



# Lisa Club

design **Marcello Ziliani**

**Chair Lisa Club** — 2874 ZO P86  
sedia



**Seat and backrest are made with an extruded PVC weave. Refined in the structure/frame combinations, light to move and stackable, it is an informal piece of furniture for outdoor locations.**

*Seduta e schienale sono realizzati con un intreccio in estruso di PVC. Ricercata negli abbinamenti struttura/telaio, leggera da spostare e impilabile, è un arredo informale per location outdoor.*



**Armchair Lisa Club** — 2873 ZA P86  
poltrona

**Base Tiffany** — 5182 VA  
basamento



**Barstool Lisa Club h.75** — 2875 ZE P73  
*sgabello*



**Chair Lisa Club** — 2874 ZT P10  
*sedia*

**Armchair Lisa Club** — 2873 ZA P86  
*poltrona*

# Lisa Swing

design **Marcello Ziliani**

**Hanging armchair Lisa Swing** — 2883 ZE N30  
seduta sospesa



**The Lisa outdoor collection is joined by an original and precious complement, a suspended armchair to experience pleasure and relaxation. Lisa Swing in powder-coated tubular steel, has seat and backrest in woven nautical rope, available in many colour combinations.**

*La collezione Lisa outdoor si arricchisce di un complemento originale e prezioso, una poltrona sospesa per vivere il piacere ed il relax. Lisa Swing in acciaio tubolare verniciato a polvere, presenta seduta e schienale in corda nautica intrecciata, disponibili in numerosi abbinamenti colore.*



**Hanging armchair Lisa Swing** — 2883 ZY N84  
seduta sospesa

**Optional cushions: Sunbrella® fabric**  
Cuscini opzionali in tessuto Sunbrella®



**Hanging armchair Lisa Swing** — 2883 ZA N57  
*seduta sospesa*



**Hanging armchair Lisa Swing** — 2883 ZE N30  
*seduta sospesa*

# Squid

design RadiceOrlandini DesignStudio

**Squid Table** — 2437 VN 575  
tavolo

**HPL Sahara noir marble effect top**  
piano effetto marmo nero Sahara  
300x130



**The Squid collection is a complex system of tables that involves several materials and production technologies, giving life to a flexible and customizable product whose novelty is the material experimentation of the top and the design of the details. A table that can feature tops in HPL but also in marble and other fine materials. The fulcrum of the project is the die-cast aluminium leg, whose 'cuttlefish bone' section gives the collection its name.**

*La collezione Squid è un complesso sistema di tavoli che coinvolge diversi materiali e tecnologie produttive, dando vita ad un prodotto flessibile e personalizzabile la cui novità si gioca sulla sperimentazione materica del top e sul design dei dettagli.*

*Un tavolo in grado di accogliere piani in hpl ma anche in marmo e altri pregiati materiali. Fulcro del progetto è la gamba in pressofusione di alluminio, la cui sezione ad "osso di seppia" dà il nome alla collezione.*



**Table Squid** — 2437 VE 92  
tavolo

**HPL dove-grey spatula effect top**  
piano effetto spatolato tortora – 300x130

**S•CAB**

**Armchair Si-Si Barcode** — 2507 ZE  
poltrona

**Chair Si-Si Dots** — 2505 ZE  
sedia



**Table Squid** — 2436 VT 94  
tavolo

**HPL slate effect top**  
piano effetto ardesia – 210x110



**Chair Si-Si Dots** — 2505 ZA  
sedia

**Armchair Si-Si Barcode** — 2507 ZA  
poltrona

**S•CAB**

**Table Squid** — 2431 VA 93  
tavolo

**HPL piasentina stone effect top**  
piano effetto pietra piasentina – 210x100





# Squid M

design **RadiceOrlandini DesignStudio**

**Table Squid M** — 2438 VN 452  
tavolo

**Marble top** / piano marmo • Sahara noir  
210x110

**S•CAB**

**Armchair Lisa** — 2851 VA V4 39  
poltrona

# Squid OF

design RadiceOrlandini DesignStudio

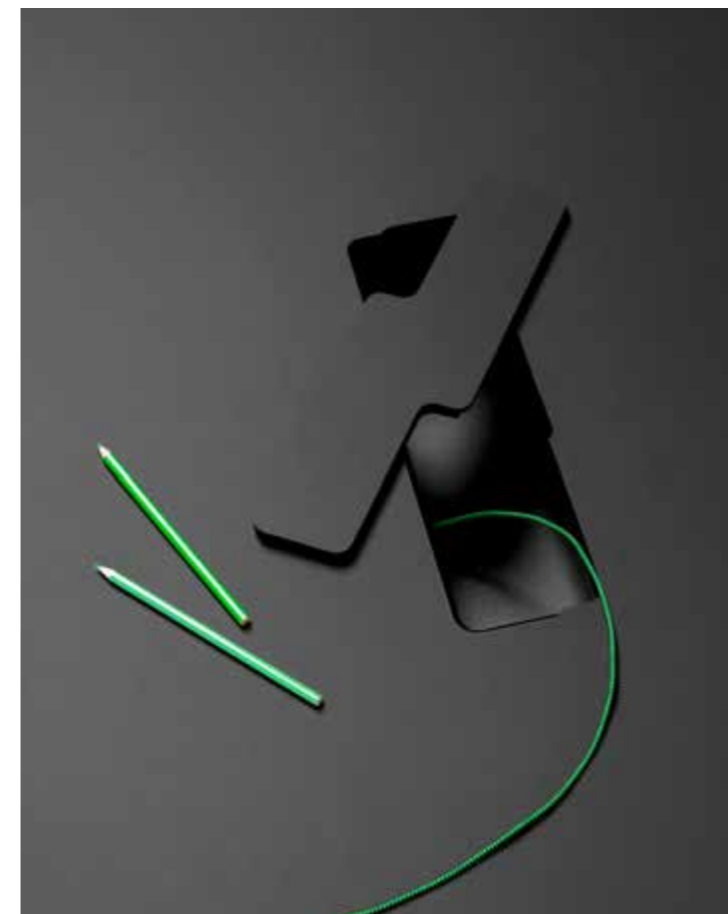

**Table Squid OF** — 2432 VN 95 OF  
tavolo

**HPL fenix black anti-fingerprint top**  
piano nero fenix anti-impronta – 300x120

**S•CAB**

**Armchair Lady B Pop swivelling on trestle base** — 2599 VN T5 26  
poltrona su trespolo girevole



**The OF version is equipped with cable ducts.**

*La versione OF è dotata di canaline per passaggio cavi.*

# Squid dimensions and finishes chart

Abaco dimensioni e finiture Squid

## Hexagonal Esagonale

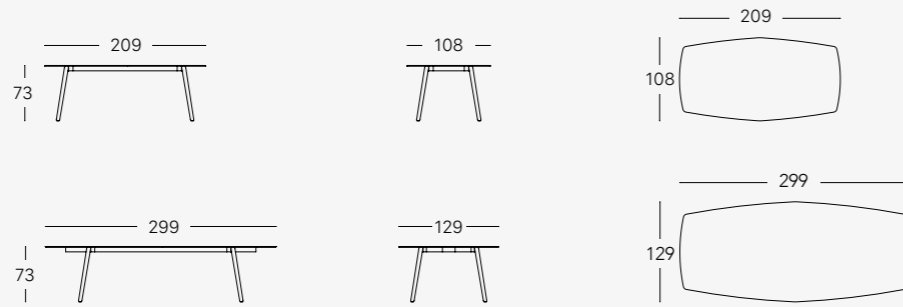

## Rectangular Rettangolare

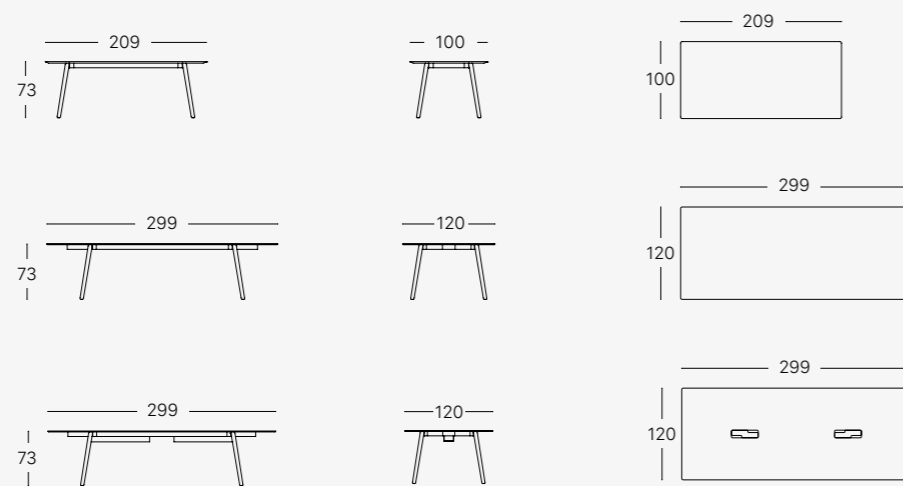

## Frame finishes Finiture telaio

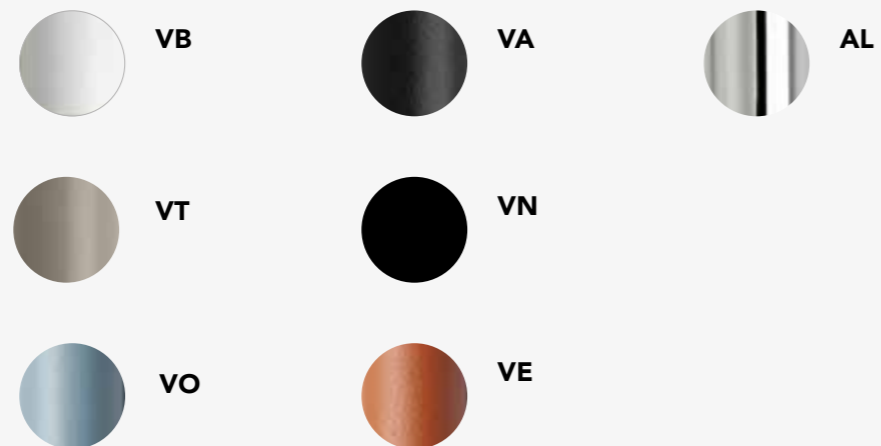

## Compact laminate top finishes Finiture piano stratificato compact

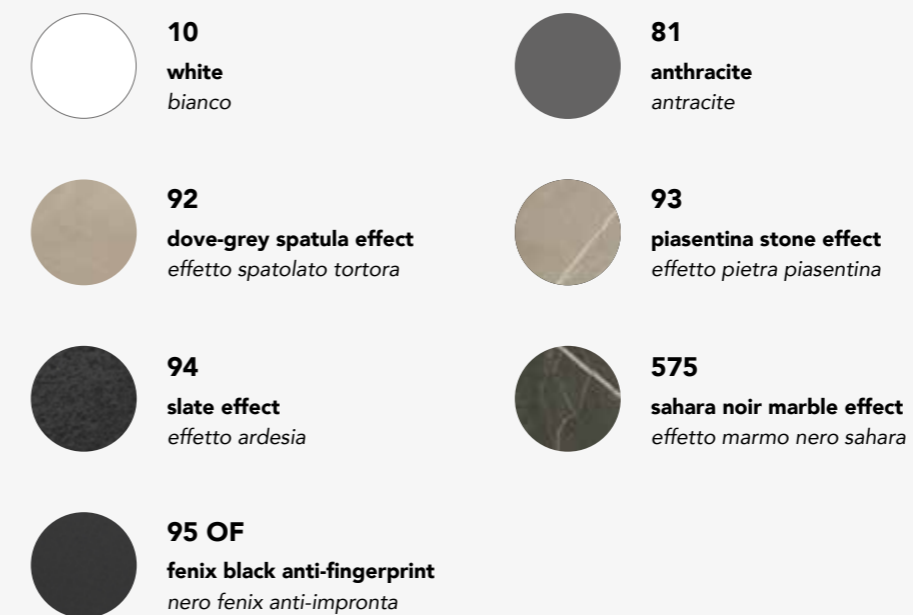

## Marble top finishes Finiture piano marmo

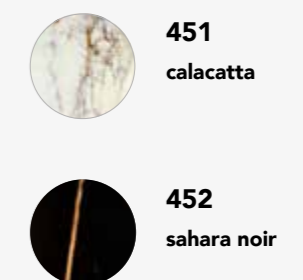

**The pursuit  
of beauty always  
finds new  
products along  
its path.**

*La ricerca del bello trova sempre  
novità sul suo cammino.*

**Si-Si<sup>90</sup>, Trick<sup>98</sup>, Finn<sup>102</sup>, Tripé<sup>110</sup>**

# Si-Si

design **Meneghello Paoletti Associati**

**Armchair Si-Si Barcode** — 2507 ZO  
poltrona



**Eclectic, chameleon-like, multi-material chair, Si-Si is a smart chair that interprets the fragile balance between indoor and outdoor. One frame and four 'bodies', with heterogeneous textures and materials, make it suitable to very different environments.**

*Seduta eclettica, Si-Si interpreta il labile equilibrio tra indoor e outdoor. Un'unica scocca, fissata allo snello telaio, funge indifferentemente da schienale e da seduta. Un telaio e quattro "scocche", con texture e materiali eterogenei, ne consentono la fruizione in ambienti molto differenti.*





**Armchair Si-Si Barcode** — 2507 ZE  
*poltrona*



**Chair Si-Si** — 2503 ZO  
*sedia*

**Armchair Si-Si** — 2502 ZT  
*poltrona*

**Chair Si-Si Dots** — 2505 ZE  
*sedia*

**Armchair Si-Si Dots** — 2504 ZL  
*poltrona*



**Armchair Si-Si Barcode** — 2507 ZT  
*poltrona*

**Chair Si-Si Barcode** — 2508 ZA  
*sedia*





**Armchair Si-Si Dots**— 2504 ZL  
poltrona



**PRETTY PLEASE**  
Interior design: ett la benn  
— Leipzig, Germany





**Zinc and polyester powder coated steel frame. Solid Sapelli mahogany wood slats treated for outdoor use.**  
*Struttura in acciaio zincato e verniciato a polvere. Doghe in legno massello mogano Sapelli trattato per esterni.*

# Trick

design **Meneghello Paoletti Associati**

**Barstool Trick Wood h.75** — 2536 OM NR  
sgabello



**The curves outline the metal structure of Trick, a barstool with an expressive and joyful design. With upholstered or wooden seat and coated frame or with galvanic finish, it is perfect as an indoor complement for a bar counter. In coated metal, it lives in in&out spaces, like the outside of venues and covered terraces.**

*Le curve delineano la struttura in metallo di Trick, uno sgabello dal design espressivo e gioioso. Con sedile imbottito o in legno e telaio verniciato o in finitura galvanica, è perfetto come complemento indoor di un banco bar. In metallo verniciato, vive in spazi in&out, come dehors e terrazze coperte.*



**Barstool Trick Pop h.75** — 2538 NL V5 A8  
sgabello



Barstool Trick h.75 — 2523 ZE  
sgabello



Barstool Trick h.65 — 2524 ZO  
sgabello

# The collection

# — Finn

design **Marcello Ziliani**

**Armchair Finn All Wood** — 2892 VE V5 A7  
*poltrona*



**Profiles with deliberately generous sections form the supporting structure of Finn, a soft and enveloping seat. Materials, colours, finishes available in different combinations enhance the personality of the chair and armchair, supporting the most varied living solutions for all situations related to the multifaceted contract world.**

*Profili dalle sezioni volutamente generose fanno da struttura portante a Finn, una seduta morbida e avvolgente. Materiali, colori, finiture declinati in differenti combinazioni esaltano la personalità di sedia e poltroncina, assecondando le più svariate soluzioni dell'abitare e per tutte le situazioni legate al multiforme mondo contract.*



**Armchair Finn Metal Wood** — 2896 VE FG  
*poltrona*

**Squid M Table** — 2433 VE 451  
*tavolo*



**Chair Finn All Wood** — 2895 HN HN  
*sedia*

**Base Tiffany h. 73** — 5173 KE  
*basamento*

**S•CAB**

**Armchair Finn All Wood** — 2894 HN HN  
*poltrona*



**Top Tiffany** — 5552 OS 574  
*piano per basamenti Tiffany*

# Finn

## finishes chart

Abaco finiture Finn



### Metal finishes

*Finiture metallo*



**OM** matt gold  
oro matt



**VE** terracotta coated  
verniciato terracotta



**BV** vintage bronze  
bronz vintage



**VA** anthracite coated  
verniciato antracite



**NB** matt nickel  
nichel matt



**NO** matt black nickel  
nichel nero matt

### Fabrics

*Tessuti*

**V5** velvet  
**V3** velluti

**T** fabric  
tessuti

**TC** customer  
own fabric  
tessuto cliente

### Wood finishes

*Finiture legno*



**HW** white stained ash  
frassino tinto bianco



**HN** blonde walnut stained ash with visible grains  
frassino tinto noce biondo a poro aperto



**HB** black stained ash with visible grains  
frassino tinto nero a poro aperto



**FA** aquamarine matt lacquered beech  
faggio laccato acquamarina opaco



**FG** grey matt lacquered beech  
faggio laccato grigio opaco

# Tripé

design RadiceOrlandini DesignStudio

**Base Tripé** — 5002 VE  
basamento



**Tripé is the right synthesis of functionality, minimalism, and recognisability. The steel base with die-cast aluminium junction is made up of several elements that can be diversified, giving life to a system of tables of various shapes and sizes, ideal for the home and public areas.**

*Tripé è la giusta sintesi di funzionalità, minimalismo e riconoscibilità. La base in acciaio con snodo in alluminio pressofuso è composta da più elementi che possono essere diversificati, dando vita ad una linea di tavoli e complementi di varie forme e misure, ideale per la casa e le aree pubbliche.*



**Base Tripé Maxi h. 50** — 5009 VE  
basamento

**Folding base Tripé h. 109** — 5001 VD  
basamento affiancabile

**Base Tripé Maxi h. 73** — 5006 VT  
basamento





**Double Base Tripé Doppio h. 73** — 5007 VB  
basamento

**Armchair Lisa Filò** — 2869 ZL N57  
poltrona

S•CAB



**Base Tripé h.109** — 5003 VB  
basamento

**Double Base Tripé Doppio** — 5007 VA  
basamento

**Base Tripé Maxi** — 5006 VT  
basamento

**S•CAB**

**Base Tripé h.50** — 5004 VT  
basamento

**Double Base Tripé Doppio** — 5007 VN  
basamento

**Base Tripé** — 5002 VD  
basamento

**Comfort is  
looking for a  
dimension where  
you can find  
yourself.**

*Il comfort è cercare una dimensione  
dove ritrovare se stessi.*

**Lisa<sup>118</sup>, Lisa Wood<sup>122</sup>, Lisa Lounge<sup>126</sup>,  
Lisa Waterproof<sup>130</sup>, Lisa Tecnopolimero<sup>132</sup>,  
Lady B<sup>136</sup>, Natural Lady B Pop<sup>142</sup>, Lady B Pop<sup>146</sup>,  
Pranzo Allungabile<sup>148</sup>, Zebra<sup>154</sup>, Zebra Bicolore<sup>160</sup>**

# Lisa

design **Marcello Ziliani**

**Armchair Lisa** — 2851 NL  
poltrona



**A tribute to the refined atmosphere of the interiors of the 50s and 60s, Lisa is elegant in all its versions applied to the contract world. Chair, armchair, and barstools are characterized by a thin tubular frame that envelops and supports padded seat and backrest.**

*Omaggio alle raffinate atmosfere degli interni anni '50 e '60, Lisa è elegante in tutte le versioni applicate al mondo contract e domestico. Sedia, poltroncina e sgabelli si caratterizzano per un sottile telaio tubolare che contorna e sostiene seduta e schienali imbottiti.*

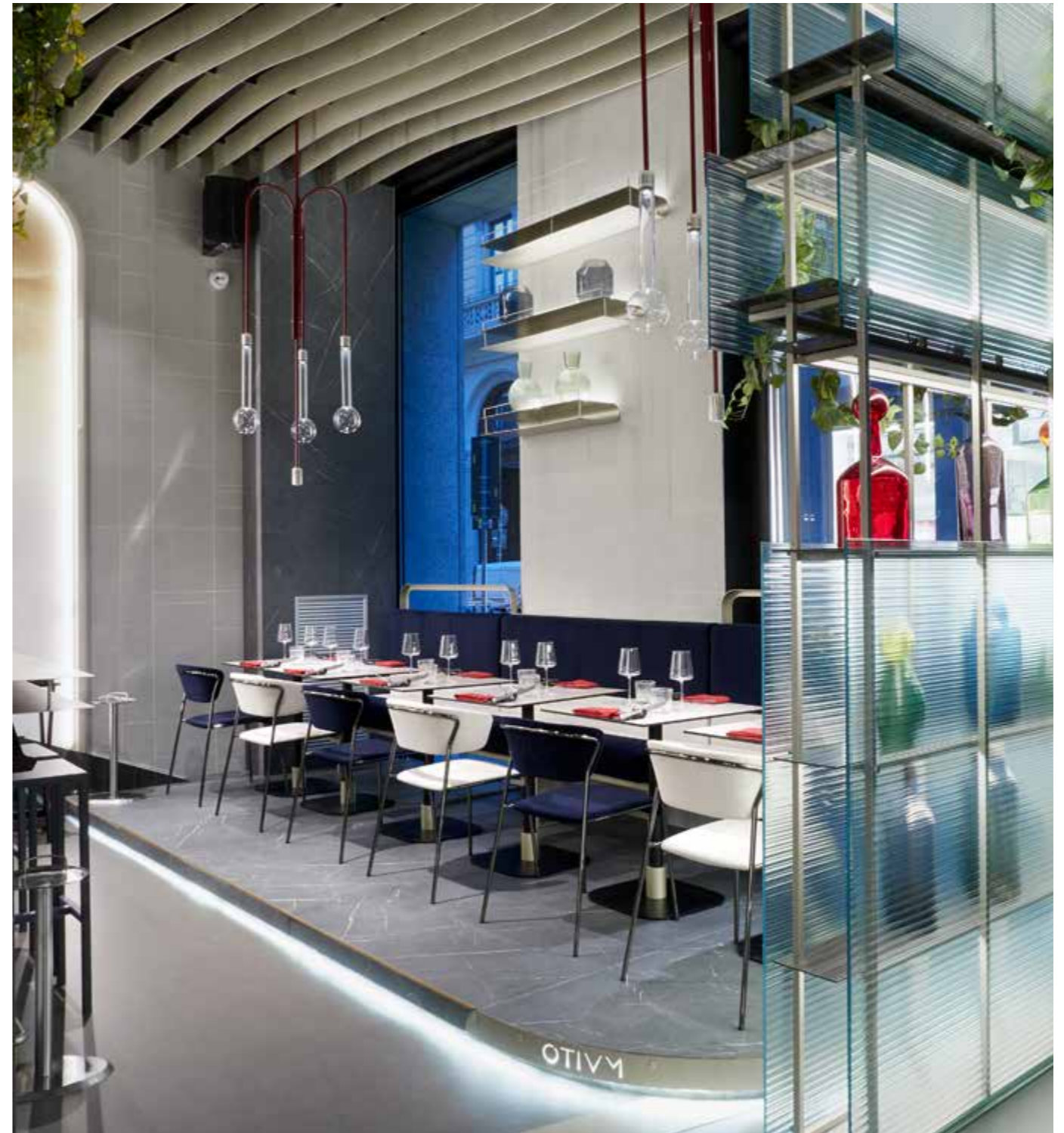



**LINFA - EAT DIFFERENT**

Architetto: Riva Simone Factory Design Studio  
— Milan, Italy

**THE CORNER**

Vitachiara Habitat — Cuneo, Italy

**Chair Lisa** — 2853 OS  
*sedia*

**Barstool Lisa h.75** — 2855 NL V3 57  
*sgabello*



# Lisa Wood

design **Marcello Ziliani**

**Armchair Lisa Wood** — 2850 NL NC  
*poltrona*



**For a sophisticated touch, seat and backrest are made of curved beech plywood, available in natural finish, eastern American black walnut, natural oak, or open-pore black-lacquered oak.**

*Per un tocco sofisticato, seduta e schienale sono realizzati in multistrato curvato di faggio, disponibile nelle finiture naturale, noce canaletto, rovere naturale o laccato nero a poro aperto.*





**MISS DÔ** Martino Sacchi  
Rhizomet — Berlin, Germany

**Chair Lisa Wood** — 2852 NL RN  
sedia



**LUPPOLO&FARINA** DDS + Architects  
— Arch. Giuseppe De Donno — Brindisi, Italy

**Barstool Lisa Wood h.75** — 2854 VA RN  
sgabello

# Lisa Lounge

design **Marcello Ziliani**

**Armchair Lisa Lounge** — 2858 VE V4 39  
*poltrona*

**Pouf Lisa Lounge** — 2859 VE V4 39



**The Lisa series is available in a new lounge dimension, suitable for relaxation, enveloping and comfortable. The sled armchair can be complemented by a comfortable optional pouf.**

*La serie Lisa viene declinata in una nuova dimensione lounge, adatta al relax, avvolgente e comoda. La poltrona a slitta si completa con un comodo pouf opzionale.*



**DASTE BISTRÒ** OKAM Studio + Daniele Fazio Studio  
— Bergamo, Italy

**Armchair Lisa Lounge** — 2858 VA V4 50  
*poltrona*



The collection  
**— Lisa**



**Armchair Lisa Lounge** — 2858 NL V4 50  
*poltrona*

**Pouf Lisa Lounge** — 2859 NL V4 50  
*pouf*

**S•CAB**

**Chair Lisa** — 2853 NL V4 50  
*sedia*

**Barstool Lisa h.75** — 2855 NL V4 50  
*sgabello*

**Armchair Lisa** — 2851 NL V4 50  
*poltrona*

# Lisa Waterproof

design **Marcello Ziliani**

**Barstool Lisa Waterproof h.75** — 2862 ZO WP 86  
sgabello



**The wide Lisa family extends toward the outdoors. The Waterproof version is characterized by the new outdoor covering in four colours with a tubular steel structure matched to play with the tones of sand, olive green, light blue, and marsala.**

*Lisa si apre all'outdoor. La versione Waterproof si caratterizza per gli inediti rivestimenti per esterni in quattro colori con struttura in acciaio tubolare abbinata per giocare con i toni del sabbia, del verde oliva, dell'azzurro e del marsala.*



# Lisa Tecnopolimero

design **Marcello Ziliani**

**Chair Lisa Tecnopolimero** — 2865 VT 15  
sedia



**In this version, Lisa has a technopolymer seat and backrest. Soft shapes that convey a pleasant sense of richness and solidity, the tactile quality in the finishing of the surfaces and the choice of contemporary colours, make the chair and barstool habitués of the most fashionable contract environments.**

*In questa versione, Lisa presenta seduta e schienale in tecnopolimero. Forme soft che comunicano un piacevole senso di ricchezza e solidità, la qualità tattile nella finitura delle superfici e la scelta di colori contemporanei, rendono sedia e sgabello habitué degli spazi contract più alla moda.*

go  
green  
Option / opzione

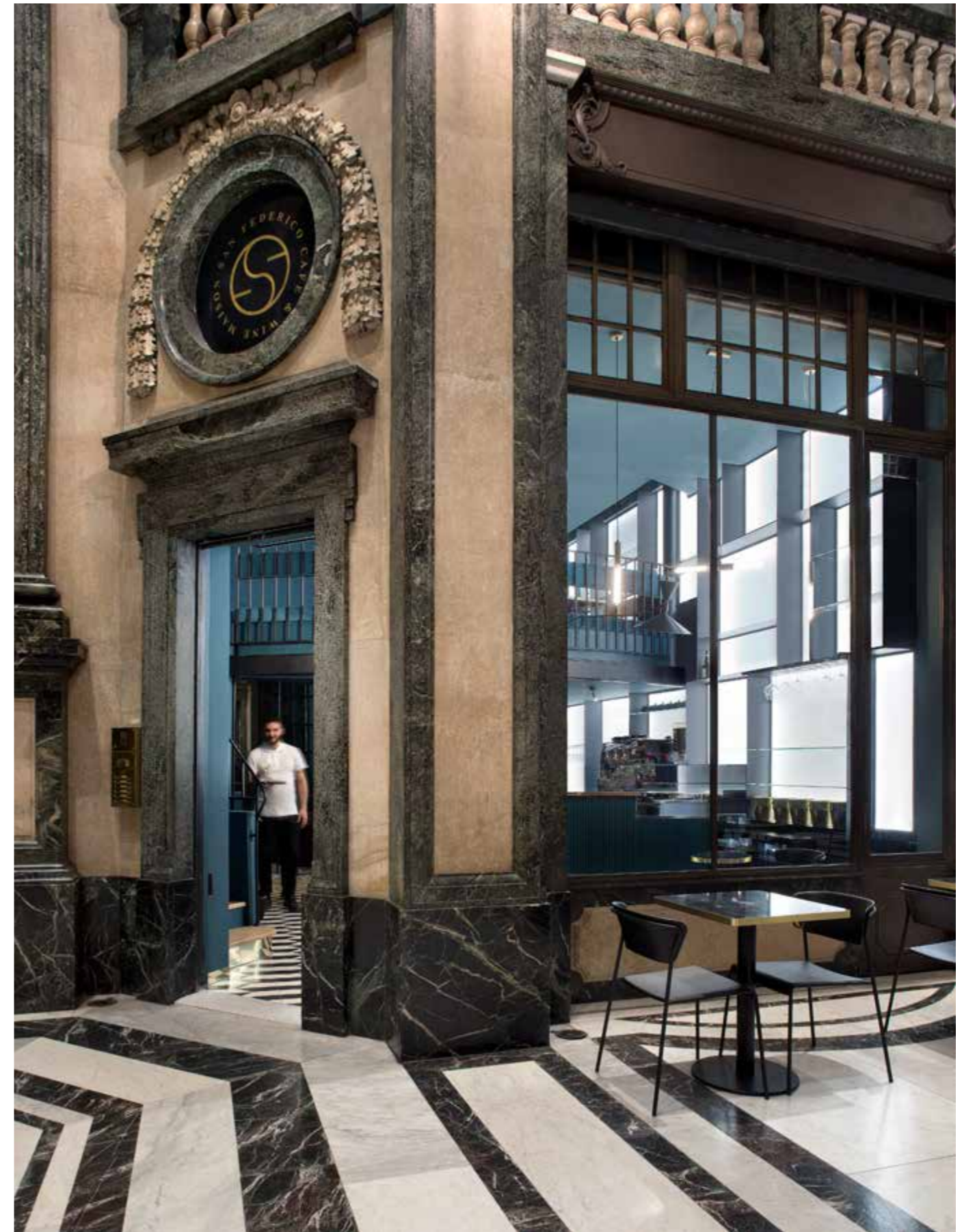

**MAISON SAN FEDERICO CAFÈ & WINE**  
Velvet Studio — Torino, Italy

**Chair Lisa Tecnopolimero** — 2865 VA 81  
sedia



**Base Tiffany** — 5182 KE  
*basamento*

**S•CAB**

**Chair Lisa Tecnopolimero** — 2865 VY 22  
*sedia*

**Barstool Lisa Tecnopolimero h.75** — 2867 VY 22  
*sgabello*

# Lady B

design **Studio Zetass**

**Armchair Lady B** — 2696 VY 22  
poltrona



**Enveloping, sinuous, and with a look that is able to combine comfort and grit, Lady B inhabits the contract world with style. It is available in technopolymer or upholstered seat to match with beech wood or seven metal frame options, including nickel black and satin brass.**

*Avvolgente, sinuosa e con un look in grado di unire comfort e grinta, Lady B abita con stile il mondo contract. In tecnopolimero con scocca nuda o imbottita, ha telaio in faggio o in acciaio in sette finiture tra cui il prezioso nichel nero e l'ottone satinato.*

go  
green  
Option / opzione

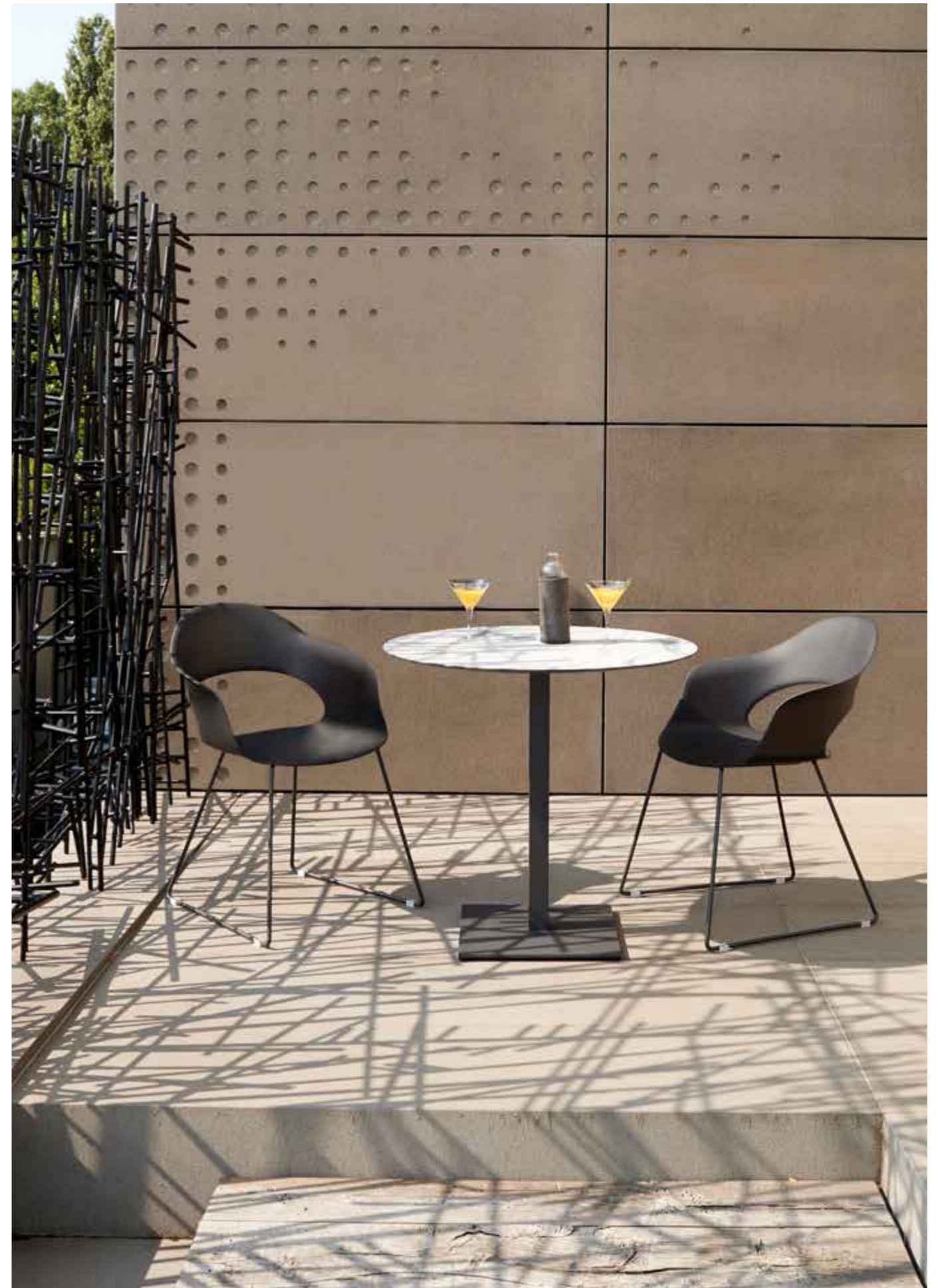

**Armchair Lady B, sledge frame** — 2697 VA 81  
poltrona a slitta

**Base Tiffany** — 5182 VA  
basamento



**"AL SANTUARIO" Caffè e Bistrot**  
Adro, Brescia, Italy

**Armchair Lady B** — 2696 VN 80  
*poltrona*

**S•CAB**



**HILL COLLE BISTROT**  
Erbusco, Italy

**Base Tiffany h.73** — 5182 VN  
*basamento*

**Armchair Lady B** — 2696 VT 15  
*poltrona*



**Armchair Natural Lady B** — 2843 FS 11  
*poltrona*

**Armchair Natural Lady B** — 2843 FS 22  
*poltrona*



**Armchair Lady B** — 2696 VE 73  
*poltrona*

**Armchair Lady B, sledge frame** — 2697 VN 63  
*poltrona con telaio a slitta*



**Armchair Lady B Pop, sledge frame** — 2699 VA T9 85  
*poltrona con telaio a slitta*

**Armchair Lady B Pop** — 2698 NL T9 78  
*poltrona*

**Armchair Lady B Pop** — 2698 VT T9 79  
*poltrona*



# Natural Lady B Pop

design **Studio Zetass**







**Armchair Natural Lady B Pop** — 2844 FS K1 90  
*poltrona*

**Base Tiffany** — 5182 KE  
*basamento*

# Lady B Pop

design **Studio Zetass**

**Armchair Lady B Pop with wheels** — 2598 VN T9 80  
*poltrona con ruote*



**Particularly suitable for home office solutions, it is the padded version with four-spoke frame with or without wheels, which envelops in elegance and comfort those who are just passing by for a meeting and those who remain seated for the whole day. The wide range of colours allows you to customize the environment according to your style.**

*Particolarmente adatta alle soluzioni home office, è la versione imbottita con telaio a quattro razze con o senza ruote, che avvolge nell'eleganza e nel comfort chi è di passaggio per una riunione e chi vi rimane seduto per tutto il giorno. L'ampia gamma di colori permette di personalizzare l'ambiente secondo il proprio stile.*



**Armchair Lady B Pop swivelling on trestle base** — 2599 VN T5 26  
*poltrona su trespolo girevole*

# Pranzo Allungabile

design Centro Stile S•CAB

In a simple gesture, the Pranzo Allungabile table can be extended to offer an indoor and outdoor hospitality without boundaries. It has a compact HPL top available in several finishes and a structure in galvanized and powder-coated steel with a matt effect.

**2 sizes:** from 160 to 210 cm  
and from 120 to 160/200 cm.

*In un semplice gesto, il tavolo Pranzo si allunga per offrire un'ospitalità indoor e outdoor senza confini. Ha un piano in stratificato HPL disponibile in diverse finiture e struttura in acciaio zincato e verniciato a polvere effetto opaco.  
2 misure: da 160 a 210 cm e da 120 a 160/200 cm.*





**Extendable table Pranzo Allungabile 160/210**  
— 2418 VT 90 — tavolo

**Chair Lisa Filò — 2870 ZT N15**  
sedia

**Armchair Lisa Filò — 2869 ZT N15**  
poltrona

# Pranzo Allungabile 120/160/200

design Centro Stile S•CAB



# The collection

# Zebra

design **Luisa Battaglia**

**Chair Zebra Tecnopolimero** — 2615 VA 81  
sedia



**Zebra is a versatile collection, which offers multiple frame versions and a wide range of finishes, including the total black look and the precious variant with satin brass effect. From the version with technopolymer body to the upholstered version of Natural Zebra Pop, with frame in natural, bleached, or wenge-stained beech.**

*Zebra è una collezione poliedrica, che offre molteplici versioni di telaio e un'ampia gamma di finiture, tra le quali il look total black e la preziosa variante con effetto ottone satinato. Dalla versione con scocca in tecnopolimero si passa a quella imbottita di Natural Zebra Pop, con telaio in faggio naturale, sbiancato o tinto wengé.*



**SANDEN HOTEL**  
— Hokksund, Norway

**Chair Natural Zebra Pop** — 2806 FS T5 26  
sedia

**Ideal for contract environments,  
Zebra Pop combines elegance with  
the possibility of being easily stacked  
thanks to an underbody shell.**

*Ideale per gli ambienti contract, Zebra  
Pop unisce l'eleganza alla possibilità di  
essere facilmente impilata grazie a un  
carter sottoscocca.*

**Chair Zebra Pop** — 2640 OS V4 47  
sedia

**Base Tiffany** — 5170 OS  
basamento





**THE BRIDGE WROCLAW,  
MGALLERY HOTEL** — Wrocław, Poland

**Sledge chair Zebra Pop** — 2641 CR T3 25  
sedia a slitta

**Zebra Antishock, 4-leg frame** — 2273 310  
sedia a 4 gambe



**COURTYARD BY MARRIOTT**  
— Bucharest, Romania

**Chair Zebra Pop** — 2640 VA  
sedia



# Zebra Bicolore

design **Luisa Battaglia**



**Chair Zebra Bicolore** — 2272 VB  
sedia



**Barstool Zebra Bicolore** — 2560 VA 214  
sgabello

**Each time,  
design reinvents  
environments,  
creating new  
situations.**

*Ogni volta il design reinventa gli spazi,  
creando nuove situazioni.*

**Metropolis<sup>164</sup>, Tiffany<sup>166</sup>, Rhino<sup>172</sup>,  
Nemo<sup>174</sup>, Summer<sup>176</sup>**

# The collection \_\_\_\_\_ **Metropolis**

design **Centro Stile S•CAB**

**Base Metropolis XL** — 7013 VF 001  
*basamento*



**Different sizes and finishes make Metropolis a collection of tables with urban versatility. Base with compact laminated rectangular top or in 12 mm thick tempered glass, legs and crosspiece in steel or natural beech. Adjustable swivelling feet for level positioning.**

*Differenti dimensioni e finiture rendono Metropolis una collezione di tavoli dalla versatilità urban. Basamento con piano rettangolare stratificato compact o in vetro temperato 12 mm, gambe e traversa in acciaio o in faggio naturale. Piedini orientabili e regolabili.*



**Base Metropolis L - top 180x90 cm** — 7014 VF 001  
*basamento*

**Chair Zebra Pop** — 2640 VA M2 09  
*sedia*

# The collection Tiffany

design Centro Stile S•CAB

**Base Tiffany** — 5182 KE  
*basamento*



**Thanks to the wide range of models, Tiffany is an across-the-board furnishing accessory for all the turnkey solution sector. Tiffany range includes bases with square or round base and column that can be combined with tops in different sizes and finishes.**

*Grazie alla vasta gamma di modelli, Tiffany è un complemento d'arredo trasversale in tutto il settore contract. La collezione Tiffany comprende una serie di basamenti con base e colonna quadrate o tonde abbinabili a piani in diverse dimensioni e finiture.*



**Base Tiffany** — 5182 VA  
*basamento*

**Chair Lisa Club** — 2874 ZL P10  
*sedia*



**Base Tiffany** — 5173 VT  
*basamento*

**Chair Si-Si** — 2503 ZT  
*sedia*

**Armchair Si-Si** — 2502 ZT  
*poltrona*

**S•CAB**

**Chair Si-Si Barcode** — 2508 ZV  
*sedia*

**Armchair Si-Si Barcode** — 2507 ZV  
*poltrona*



**Base Tiffany** — 5170 OS  
basamento

**Chair Lisa Tecnopolimero** — 2865 VL 11  
sedia

**S•CAB**

**Top Tiffany** — 5550 OS 572  
piano per basamenti Tiffany



# Rhino

design **Luisa Battaglia**

**Rhino** — 5184 VN  
tavolo



**Expression of a minimal and refined design, the Rhino table has a look that allows versatile contract applications. It can be combined with tops of different sizes and finishes, and it stands out for a square base in coated cast iron, with characteristic rounded corners. Available in three heights, it is particularly stable thanks to the shape of the base and the adjustable feet.**

*Espressione di un design minimal e ricercato, il tavolo Rhino presenta un look che permette versatili applicazioni contract. Abbinabile a top di diverse dimensioni e finiture, si distingue per una base quadrata in ghisa verniciata, dai caratteristici angoli raggiati. Disponibile in tre altezze, si rivela particolarmente stabile grazie alla forma stessa della base e ai piedini regolabili.*



**Base Rhino** — 5184 VN  
basamento

**Chair Lisa Tecnopolimero** — 2865 VN 80  
sedia

# Nemo

design **Roberto Semprini**

**Double Nemo Folding base** — 5072 AV 81  
*basamento affiancabile*



**The Nemo table, combinable with tops of various sizes and finishes, was created to meet the needs of practicality and compactness. Available in different heights for the alignment and the fixed version, it has a handle to facilitate the alignment of multiple tables.**

*Abbinabile a top di diverse dimensioni e finiture, il tavolo Nemo nasce per soddisfare esigenze di praticità e compattezza. Disponibile in diverse altezze sia per la versione fissa che per quella affiancabile, che dispone di una maniglia per facilitare l'allineamento di più tavoli.*



**Base Nemo** — 5060 AV 81  
*basamento*

**Alice Pop** — 2673 VA V4 38  
*chair*



# Summer

design **Roberto Semprini**

**Armchair Summer** — 2520 VV  
poltrona



**With minimalist lines and a summer flavour, the Summer collection in zinc and coated steel rod includes stackable and multi-coloured seats and stools. The precious version in satin brass finish is ideal for indoor use.**

*Dalle linee essenziali e dal sapore estivo, la collezione Summer in tondino d'acciaio zincato e verniciato comprende sedute e sgabelli impilabili e multicolori. Preziosa la versione in finitura ottone satinato ideale per uso interno.*

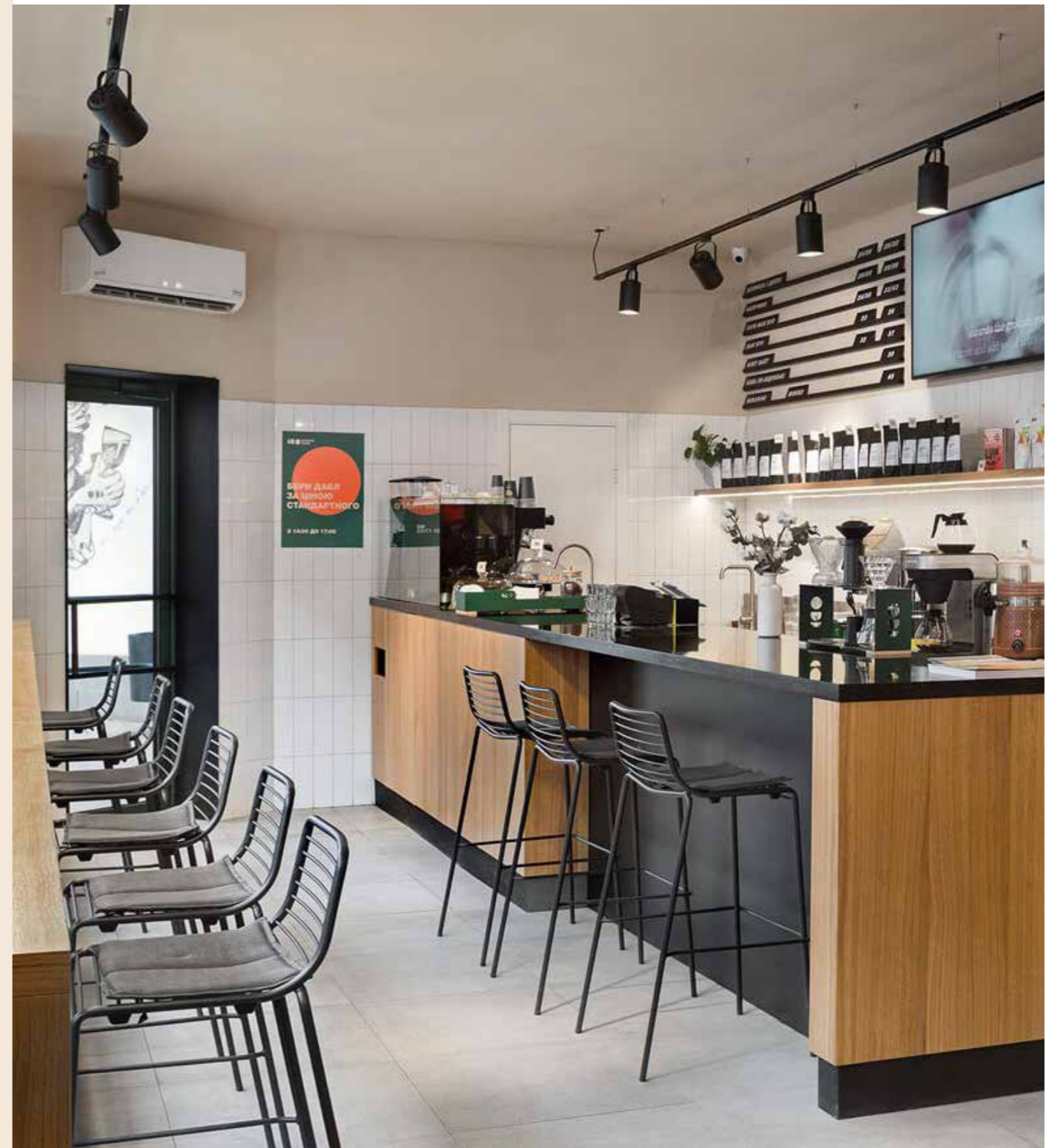

**Table Leo Ø60 h.73** — 2719 VZ  
tavolino

**Chair Summer** — 2522 VZ  
sedia

**Armchair Summer** — 2520 VZ  
poltrona

**HAWAIIAN POKE** Hula  
— Bari, Italy



**VLASNA KAVA CAFÈ**  
— Charkiv, Ukraine

**Barstool Summer** — 2535 VA  
sgabello

**Versatility  
is feeling good  
wherever you  
are.**

*La versatilità è stare bene  
ovunque ci si trovi.*

**Ginevra<sup>182</sup>, Kate<sup>184</sup>, Emi<sup>186</sup>, Sunset<sup>188</sup>, Vela<sup>190</sup>  
Side Table Vela<sup>191</sup>**

# Ginevra

design **Centro Stile S•CAB**

**Chair Ginevra** — 2334 15  
sedia



**Ginevra, with or without armrests, represents exceptional comfort. The technopolymer frame means it can be used both in public meeting places and in the garden at home. The Ginevra collection is completed by the Lounge version with a wider seat.**

*Ginevra con o senza braccioli integrati regala un comfort d'eccellenza. La struttura in tecnopolimero ne permette l'utilizzo sia in spazi d'incontro e pubblici che nel giardino di casa. La collezione Ginevra si completa con la versione Lounge dalla seduta più ampia e avvolgente.*

go  
green  
Option / opzione



**Side table Argo** — 2151 15  
tavolino

**Ginevra Lounge** — 2351 15  
poltrona

# Kate

design **Arter&Citton**

**Chair Kate** — 2341 56  
sedia



**With a sober personality, Kate is minimalistic in its perimeter lines. The stackability and the lightness of the technopolymer frame make the use in the most varied indoor and outdoor contract environments very easy. The barstool, available in two heights, completes the collection.**

*Dalla personalità sobria, Kate ha tratti minimali nelle linee di perimetro. L'impilaggio e la leggerezza della struttura in tecnopolimero ne agevolano l'utilizzo negli spazi contract indoor e outdoor più vari. Lo sgabello disponibile in due altezze ne completa la collezione.*



**Barstool Kate h.75** — 2344 56  
sgabello

# Emi

design **Arter&Citton**

**Barstool Emi h.75** — 2345 73  
sgabello



**The Emi family, made in technopolymer and easily stackable, is a versatile solution for outdoor environments. With a traditional look patterned with small holes it includes the barstool version, offered in two heights and a wide range of colours.**

*La famiglia Emi, in tecnopolimero e facilmente impilabile, rappresenta una soluzione versatile per gli spazi outdoor. Dall'estetica tradizionale, decorata con piccoli fori, comprende la versione sgabello proposto in due altezze e in un'ampia gamma cromatica.*



**Chair Emi** — 2343 73  
sedia

**Armchair Emi** — 2342 56  
poltrona

# Sunset

design **Luisa Battaglia**

**Armchair** — 2329 62  
sedia



**With a classic and elegant slatted design, this armchair is roomy and comfortable, easy to stack, and with a frame in fibreglass reinforced technopolymer. The ergonomic, easy to handle shape blends in perfectly with any style of outdoor furnishing for restaurants, urban outdoor seating areas or at home in the garden.**

*Classica ed elegante nella sua silhouette a doghe, è una poltrona ampia e confortevole, facilmente impilabile, con struttura in tecnopolimero rinforzato in fibra di vetro. La forma ergonomica e maneggevole si armonizza con ogni tipologia di arredo nello spazio esterno di un ristorante, in un dehors di città o nel giardino di casa.*



# Vela

design **Gianluca Pasotti**

**Sun-bed Vela** — 2044 81 T81  
lettino



**Elegant and functional, Vela is a stackable sun bed that reinvents the rules for relaxation. It has a frame made with technopolymer enriched with glass fibre, with injection moulded using "Air moulding" technology, adjustable back, quick-change cover, and is equipped with wheels. The Vela side table in technopolymer recalls the gentle and rounded shapes of the sun bed of the same name and it is equipped with a removable shelf that can also become a tray.**

*Elegante e funzionale, Vela è il lettino da sole impilabile che reinventa le regole del relax. Ha telaio in tecnopolimero arricchito con fibra di vetro e stampato con tecnica air moulding, schienale regolabile, telo reversibile e facilmente ricambiabile, ed è dotato di ruote integrate. Il tavolino Vela in tecnopolimero riprende le linee dolci e arrotondate del lettino omonimo, è dotato di un ripiano estraibile che può diventare pratico vassoio.*

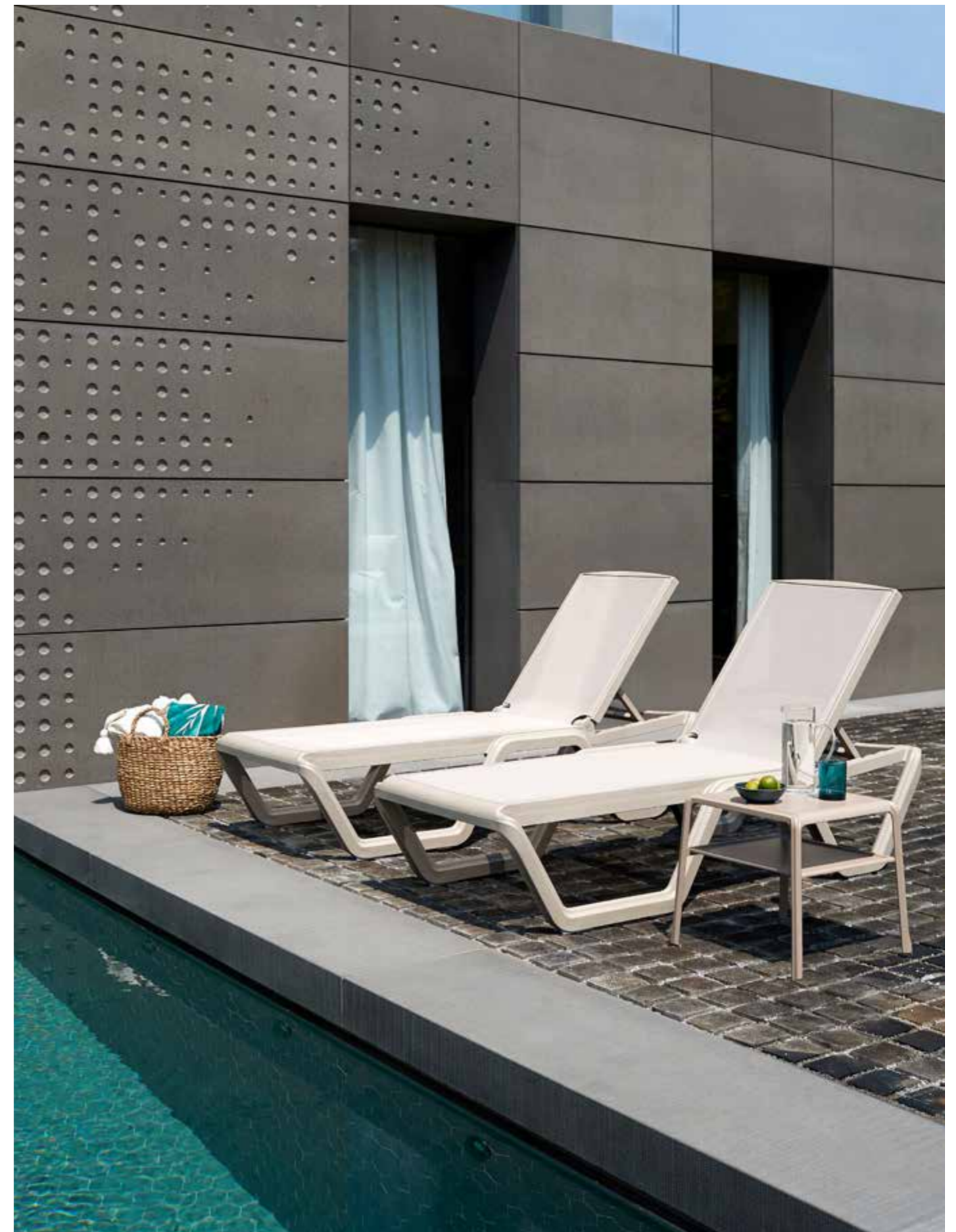

**Sun-bed Vela** — 2044 15 T15  
lettino

**Side table Vela** — 1897 15  
tavolino



# Some products make history and become style icons.

*Alcuni prodotti fanno la storia  
e diventano icone di stile.*

**Alice<sup>194</sup>, Alice Pop<sup>194</sup>, Bench Alice<sup>194</sup>, Smilla<sup>194</sup>,  
Giulia<sup>194</sup>, Drop<sup>195</sup>, Mannequin<sup>195</sup>, Zeus Pop<sup>195</sup>,  
Miss B<sup>196</sup>, You&Me<sup>196</sup>, Day<sup>197</sup>, Diavoletto<sup>197</sup>,  
Diablito<sup>197</sup>, Titì<sup>198</sup>, Spoon<sup>198</sup>, Glenda<sup>198</sup>, Igloo<sup>198</sup>,  
Vanity<sup>198</sup>, Isy<sup>198</sup>, Più<sup>198</sup>, Sai<sup>199</sup>, Sirio<sup>200</sup>, Pepper<sup>200</sup>,  
Colette<sup>200</sup>, Gio<sup>200</sup>, Cokka<sup>200</sup>, Top Gio<sup>200</sup>, Coccolona<sup>200</sup>,  
Chloè<sup>200</sup>, Ola<sup>201</sup>, Divo<sup>202</sup>, Maxi Diva<sup>202</sup>, Jenny<sup>202</sup>,  
Lucrezia<sup>202</sup>, Tahiti<sup>202</sup>, Lisa Swing with self-supporting  
structure<sup>203</sup>, Tiffany Collection<sup>204</sup>, Table Bases<sup>206</sup>,  
Metropolis<sup>208</sup>, Pranzo Allungabile<sup>208</sup>, Leo<sup>208</sup>, Mirto<sup>208</sup>,  
Summer<sup>208</sup>, Eco<sup>210</sup>, Maxi Nemo<sup>210</sup>, Domino<sup>210</sup>, Maxi  
Domino<sup>210</sup>, Dodo<sup>210</sup>, Per 3<sup>211</sup>, Ercole<sup>211</sup>, Timo<sup>211</sup>, Side  
Table Vela<sup>211</sup>, Argo<sup>211</sup>**

**Alice**



**Armchair**  
— 2676

**Chair with writing table**  
— 2678

**Sledge**  
— 2677

**Chair**  
— 2675

**Natural**  
— 2823

**Barstool**  
h.65 — 2576  
h.80 — 2575

**Alice**



**Pop**  
— 2673

**Natural**  
— 2849

**Wood**  
— 2845

**Bench Alice**



**Available with up to 4 seats with shelf**  
— 2771

**Smilla**



**Technopolymer**  
— 2841

**Wood**  
— 2840

**Giulia**



**Armchair**  
— 2684

**Pop**  
— 2685

**Natural Pop**  
— 2828

**Drop**



**Armchair**  
— 2682

**Natural**  
— 2826

**Mannequin**



**Chair**  
— 2660

**Zeus Pop**



**Home office**  
— 2656



**LA FILIALE C/O L'ALBERETA  
RELAIS & CHATEAUX**  
— Brescia, Italy

### Miss B



**Antishock**  
— 2690

**Natural antishock**  
— 2800

**Pop**  
— 2686

**Natural Pop**  
— 2802

### Day



**Barstool**  
h.65 — 2306  
h.82 — 2305

**Day Twist**  
technopolymer  
— 2304

**Day Up**  
technopolymer  
— 2302

**Day Up Pop**  
— 2373

### You and Me



**Armchair You**  
— 2803

**Chair Me**  
— 2804

### You and Me



**Armchair You**  
— 2807 FS

**Chair Me**  
— 2808



### LORDS OF VERONA

Interior and lighting design project: Simone Micheli  
— Verona, Italy

### Diavoletto



**Barstool**  
— 2224

### Diablito



**Barstool**  
h.65 — 2292  
h.80 — 2291

**Titì**  
Polycarbonate



Chair  
— 2330

**Spoon**  
Polycarbonate



Chair  
— 2332

**Glenda**  
Polycarbonate



Chair  
— 2360

**Igloo**  
Polycarbonate



Chair  
— 2357

Armchair  
— 2355

Barstool  
h.65 — 2359  
h.74 — 2358

**Vanity**  
Polycarbonate



Chair  
— 2652

Armchair  
— 2654

**Isy**  
Polycarbonate



Chair  
— 2352

Barstool  
— 2353

**Più**  
Technopolymer



Chair  
— 2336

Armchair  
— 2335

Barstool  
h.65 — 2338  
h.75 — 2337



**POLITECNICO DI LECCO**  
University Campus  
— Lecco, Italy

**Sai**  
Technopolymer



Chair  
— 2275

go  
green  
— 2376



**KALISTI HOTEL  
& SUITES**  
— Santorini, Greece

**Sirio**  
Technopolymer



**Chair**  
— 2319

**Pepper**  
Technopolymer



**Chair**  
— 2325

**Colette**  
Technopolymer



**Chair**  
— 2283-6

**Armchair**  
— 2284

**Ola**  
Technopolymer



**Armchair**  
— 2120

**Natural Armchair**  
— 2115

**Gio**  
Technopolymer



**Chair**  
— 2315

**Armchair**  
— 2314

**Cokka**  
Technopolymer



**Armchair**  
— 2280

**Top Gio**  
Technopolymer



**Chair**  
— 2317

**Coccolona**  
Technopolymer



**Armchair**  
— 2320

**Sofa**  
— 1253

**Chloè**  
Technopolymer



**Chair**  
— 2638 Trend

**Armchair**  
— 2637 Trend

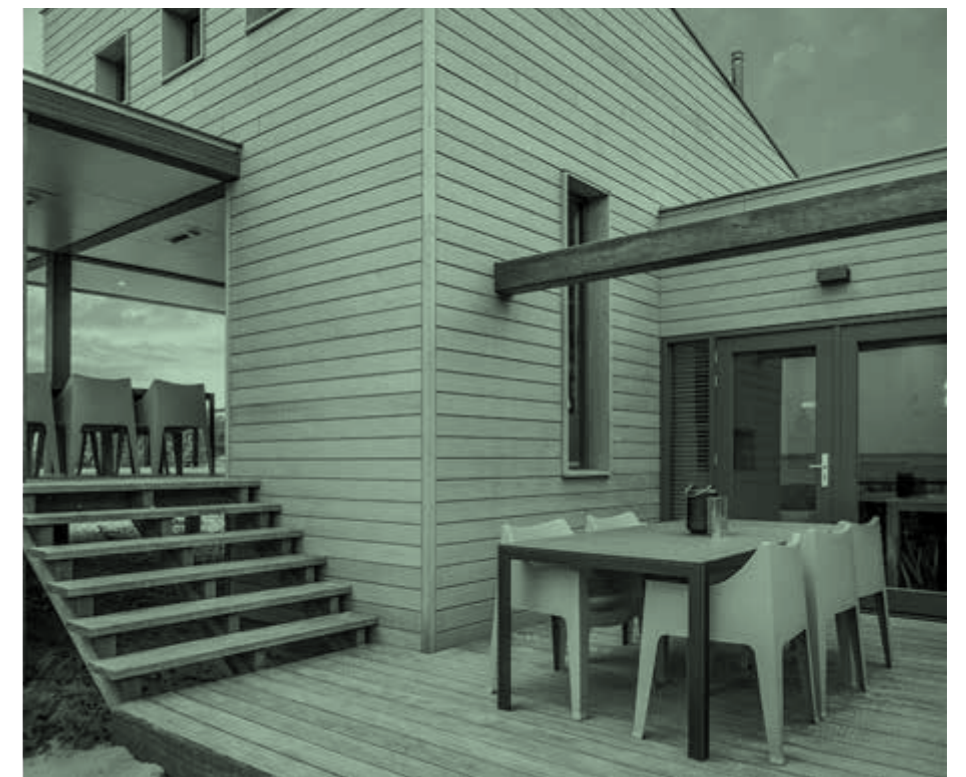

**OASIS PARCS PUNT-WEST HOTEL  
& BEACHRESORT**  
— Ouddorp, Holland

**Divo**  
Technopolymer



**Barstool**  
h.65 — 2226  
h.75 — 2216

**Maxi Diva**  
Technopolymer



**Chair**  
— 2203

**Natural**  
— 2816

**Jenny**  
Technopolymer



**Chair**  
— 2079

**Lisa Swing with self-supporting structure**  
Lisa Swing con struttura autoportante



— 2886 ZA N57



**MASSERIA VALENTE**  
— Ostuni (BR), Italy



**Lucrezia**  
Technopolymer



**Chair**  
— 2323

**Armchair**  
— 2322

**Tahiti**  
Technopolymer



**Sun-bed**  
— 2043

# Tiffany Collection

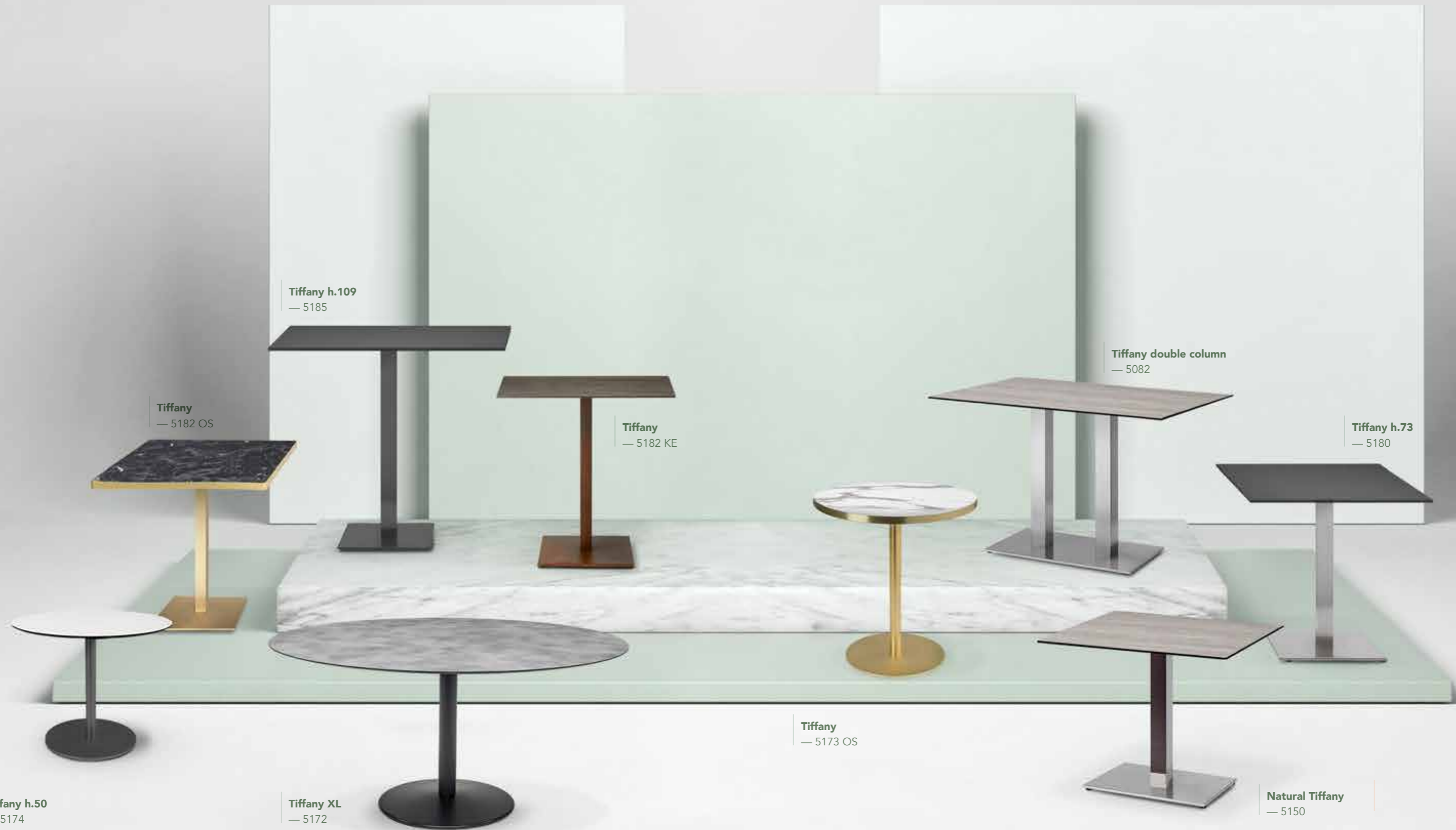

Tiffany h.109  
— 5185

Tiffany  
— 5182 OS

Tiffany  
— 5182 KE

Tiffany double column  
— 5082

Tiffany h.73  
— 5180

Tiffany  
— 5173 OS

Tiffany h.50  
— 5174

Tiffany XL  
— 5172

Natural Tiffany  
— 5150

# Table Bases

**Cross h.109**  
— 5095



**Cross h.73**  
— 5090



**Nemo folding**  
— 5070



**Tripé Double**  
— 5007



**Tripé**  
— 5002



**Nemo**  
— 5070



**Double Nemo folding**  
— 5072



**Rhino**  
— 5184



**Domino**  
— 5140





### Metropolis



L  
— 7014

XL  
— 7013

### Pranzo Allungabile



Extendable  
— 2418 — 2419

### Leo



Table  
— 2719

### Mirto



Table  
— 2421 — 2422

### Summer



Table  
— 2731 — 2732 — 2734



COFFEE BAR  
— Aarhus, Denmark

EXPIRAT CLUB  
— Bucharest, Romania



**Eco**  
Technopolymer



**Folding**  
— 2460 — 2461

**Fixed**  
— 2450 — 2451

**Eco Technopolymer**  
smooth top



**Folding**  
— 2459 — 2462

**Fixed**  
— 2449 — 2452

**Per 3**  
Technopolymer



**Extendable**  
— 1893

**Ercole**  
Technopolymer



**Table**  
— 2145

**Maxi Nemo**  
Technopolymer legs



**Folding**  
h.73 — 5030

**Fixed**  
h.73 — 5020

**Domino**



**Fixed**  
h.73 — 5141

**Folding**  
h.73 — 5160  
h.109 — 5165

**Maxi Domino**



**h.73**  
— 5110

**h.50**  
— 5111

**Timo**  
Technopolymer



**Table**  
— 2131 — 2139

**Side Table Vela**  
Technopolymer



**Side table**  
h.41 — 1897

**Argo**  
Technopolymer



**Side table**  
h.40 — 2151

**Dodo**  
for technopolymer top



**h.75** — 5200  
**h.110** — 5205











**Beauty  
of finishes  
is in details,  
in colors and  
in materials.**

*La bellezza delle finiture è nei dettagli,  
nei colori e nei materiali.*

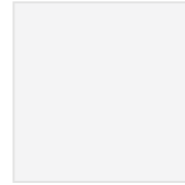





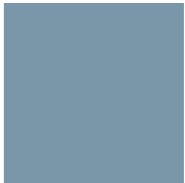





	<b>10</b> white <i>bianco</i>		<b>11</b> linen <i>lino</i>		<b>15</b> dove grey <i>tortora</i>		<b>81</b> anthracite grey <i>antracite</i>
	<b>86</b> graphite <i>grafite</i>		<b>82</b> light grey <i>grigio chiaro</i>		<b>30</b> orange <i>arancio</i>		<b>40</b> red <i>rosso</i>
	<b>42</b> geranium red <i>rosso geranio</i>		<b>20</b> yellow <i>giallo</i>		<b>22</b> mustard yellow <i>senape</i>		<b>51</b> light green <i>verde pistacchio</i>
	<b>56</b> olive green <i>verde oliva</i>		<b>62</b> light blue <i>azzurro</i>		<b>63</b> air-force blue <i>avio</i>		<b>60</b> blue <i>blu</i>
	<b>73</b> terracotta <i>terracotta</i>		<b>72</b> cocoa <i>cacao</i>		<b>70</b> bronze <i>bronzo</i>		<b>80</b> black <i>nero</i>
	<b>222</b> white - dove grey <i>bianco - tortora</i>		<b>211</b> white - orange <i>bianco - arancio</i>		<b>212</b> white - red <i>bianco - rosso</i>		<b>221</b> white - light green <i>bianco - verde pistacchio</i>
	<b>213</b> white - cornflower blue <i>bianco - fiordaliso</i>		<b>214</b> white - anthracite grey <i>bianco - antracite</i>				

POLYCARBONATE POLICARBONATO

	<b>100</b> transparent <i>trasparente</i>		<b>315</b> glossy dove grey <i>tortora pieno</i>		<b>310</b> glossy white <i>bianco pieno</i>		<b>183</b> translucent smoked <i>trasparente fumé</i>
--	---	---	--	---	---	---	---

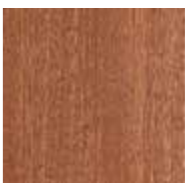
	<b>11</b> linen <i>lino</i>		<b>15</b> dove grey <i>tortora</i>		<b>17</b> caramel <i>caramello</i>		<b>81</b> anthracite grey <i>antracite</i>
	<b>22</b> mustard yellow <i>senape</i>		<b>56</b> olive green <i>verde oliva</i>		<b>58</b> sage green <i>verde salvia</i>		<b>63</b> air-force blue <i>avio</i>

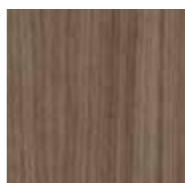
WOOD LEGNO

	<b>FN - 500</b> natural beech <i>faggio naturale</i>		<b>FS - 501</b> bleached beech <i>faggio sbiancato</i>		<b>FW - 502</b> wenge stained beech <i>faggio tinto wengé</i>		<b>FK - 503</b> smoke beech <i>faggio smoke</i>
	<b>FB</b> black stained beech <i>faggio tinto nero</i>		<b>FG - 504</b> grey matt lacquered beech <i>faggio laccato grigio opaco</i>		<b>FA</b> aquamarine matt lacquered beech <i>faggio laccato acquamarina opaco</i>		<b>HS</b> bleached ash <i>frassino sbiancato</i>
	<b>HW</b> white stained ash <i>frassino tinto bianco</i>		<b>HN</b> blonde walnut stained ash with visible grains <i>frassino tinto noce biondo a poro aperto</i>		<b>HB</b> black stained ash with visible grains <i>frassino tinto nero a poro aperto</i>		<b>IROKO</b> iroko <i>iroko</i>
	<b>RN</b> natural oak <i>rovere naturale</i>		<b>NR</b> black stained oak <i>rovere tinto nero</i>		<b>NC</b> Canaletto walnut <i>noce canaletto</i>		<b>MS</b> Sapelli mahogany <i>mogano sapelli</i>

STEEL ACCIAIO



STAINLESS STEEL ACCIAIO INOX

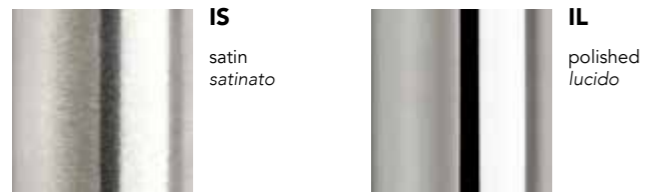

COATED STEEL ACCIAIO VERNICIATO



COATED STEEL, EMBOSSED FINISH ACCIAIO VERNICIATO, FINITURA GOFFRATA



ALUMINIUM ALLUMINIO

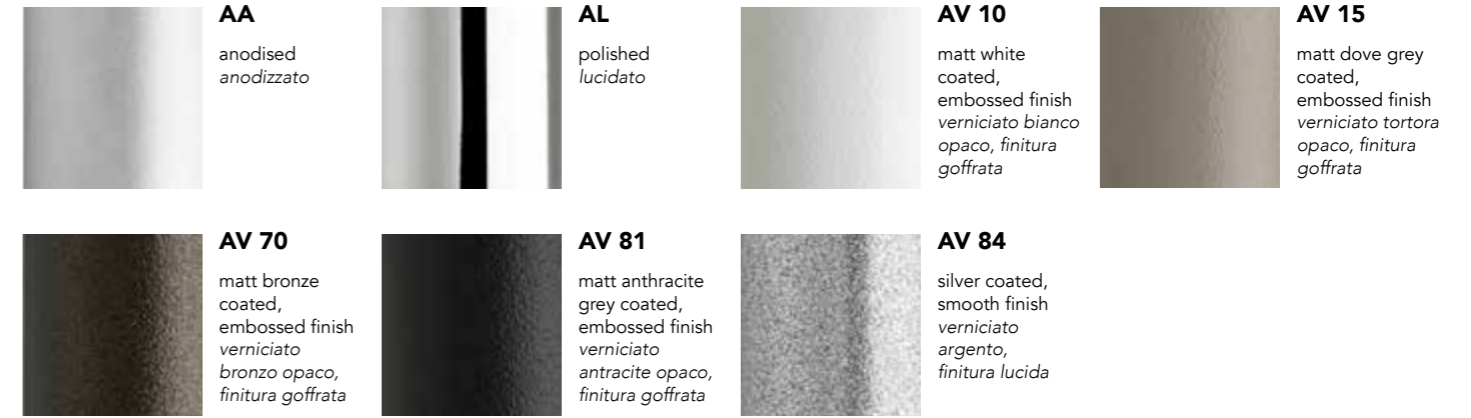

ZINC AND MATT COATED STEEL, EMBOSSED FINISH ACCIAIO ZINCATO E VERNICIATO OPACO, FINITURA GOFFRATA

INDOOR/OUTDOOR



SUMMER AND LEO FINISHES FINITURE SUMMER E LEO

ZINC AND MATT COATED STEEL, EMBOSSED FINISH ACCIAIO ZINCATO E VERNICIATO OPACO, FINITURA GOFFRATA

INDOOR/OUTDOOR



MARMO MARBLE

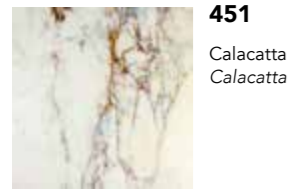

**451**  
Calacatta  
Calacatta

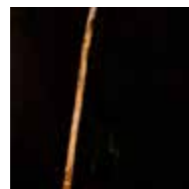

**452**  
Sahara Noir  
Sahara Noir

COMPACT LAMINATE STRATIFICATO COMPACT



**10**  
white  
bianco



**82**  
light grey  
grigio chiaro

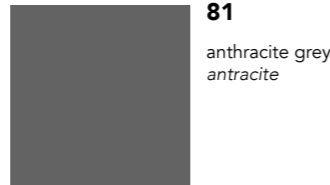

**81**  
anthracite grey  
antracite



**15**  
dove grey  
tortora



**92**  
dove-grey  
spatula effect  
effetto spatolato  
tortora



**93**  
piasentina  
stone effect  
effetto pietra  
piasentina

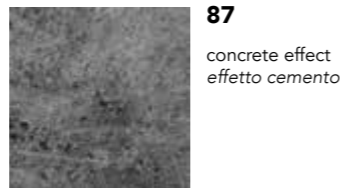

**87**  
concrete effect  
effetto cemento



**94**  
slate effect  
effetto ardesia



**90**  
stone effect  
effetto pietra



**91**  
grit effect  
effetto graniglia



**570**  
dove grey oak  
rovere tortora



**571**  
beaver oak  
rovere castoro

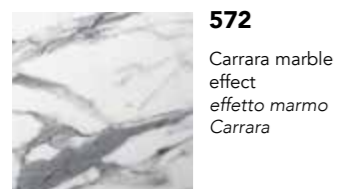

**572**  
Carrara marble  
effect  
effetto marmo  
Carrara



**574**  
black marble  
effect  
effetto marmo  
nero Impero



**575**  
black Sahara  
marble effect  
effetto marmo  
nero Sahara

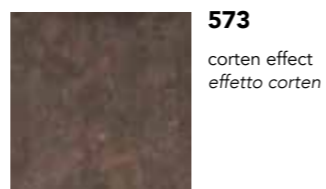

**573**  
corten effect  
effetto corten



**95 FENIX**  
black, opaque  
surface,  
anti-fingerprint  
and soft touch  
nero, superficie  
opaca,  
anti-impronta  
e soft touch

ZINC AND POWDER COATED STEEL ACCIAIO ZINCATO E VERNICIATO A POLVERE

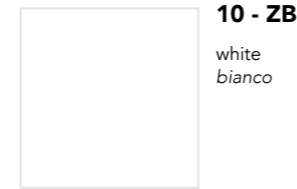

**10 - ZB**  
white  
bianco



**ZT**  
dove grey  
tortora

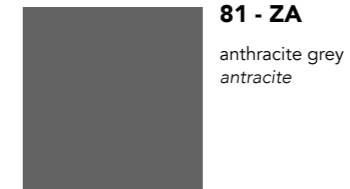

**81 - ZA**  
anthracite grey  
antracite



**ZE**  
terracotta  
terracotta



**ZO**  
air-force blue  
avio



**ZV**  
olive green  
verde oliva



**ZN**  
black  
nero

BLACK CORK FOR DRESS\_CODE SUGHERO NERO PER DRESS\_CODE



**SN**  
black  
nero

TEMPERED GLASS VETRO TEMPERATO



**412**  
white lacquered  
laccato bianco



**401**  
smoked grey  
grigio fumé

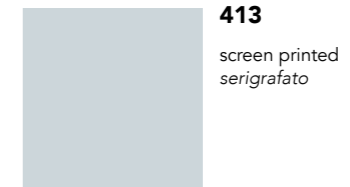

**413**  
screen printed  
serigrafato

**VELVET VELLUTO** WATER-REPELLENT IDROREPELENTE

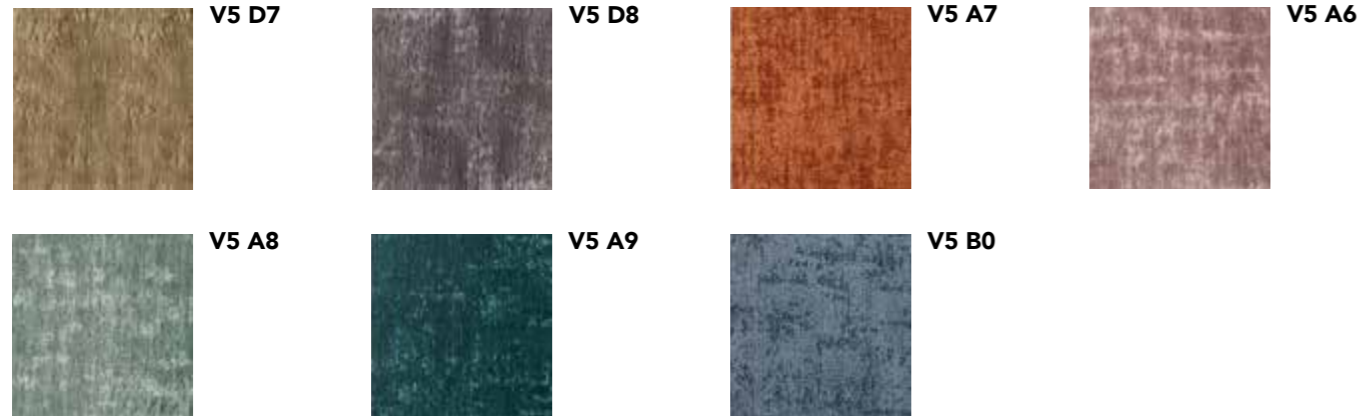

**VELVET VELLUTO**



**SIMIL-LEATHER SIMILPELLE**



**NATURAL-LEATHER CUOIO NATURALE**

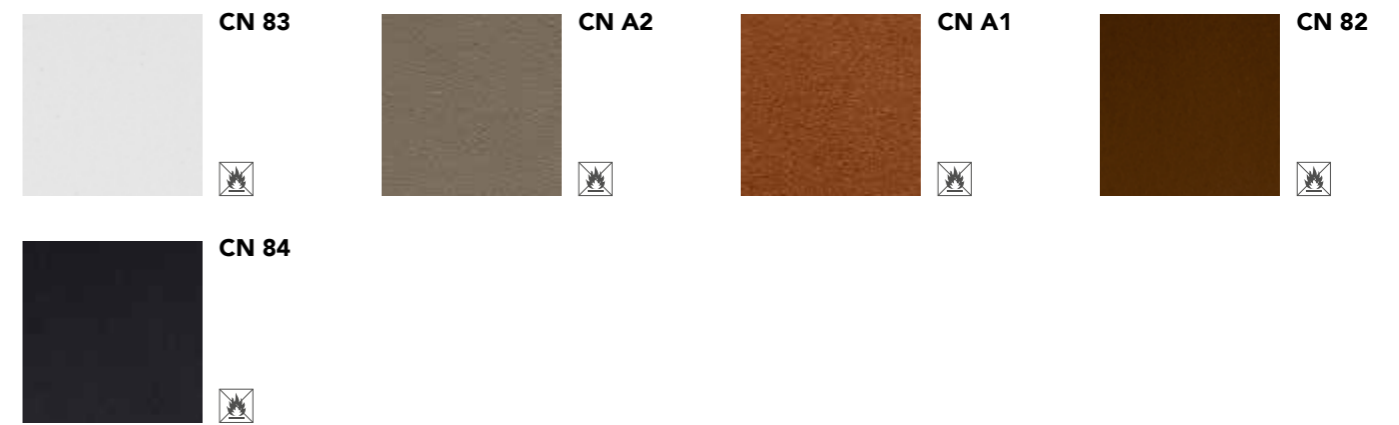

**WOOL LANA**



FABRIC TESSUTO WATER-REPELLENT IDROREPELENTE



FABRIC TESSUTO

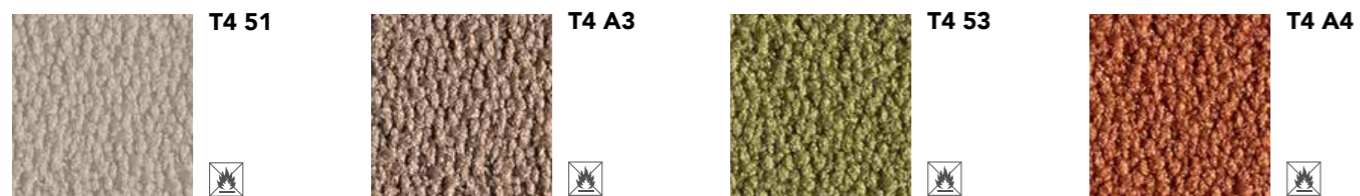

FABRIC TESSUTO STAIN RESISTANT ANTIMACCHIA

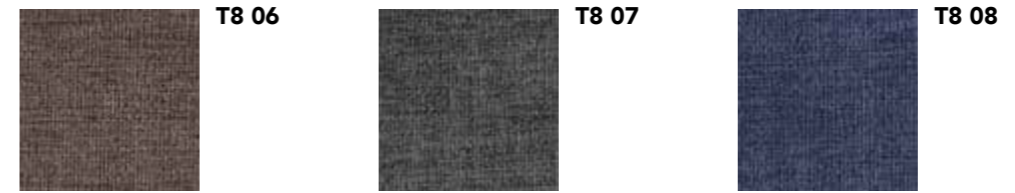

WATERPROOF ACRYLIC ACRILICO WATERPROOF

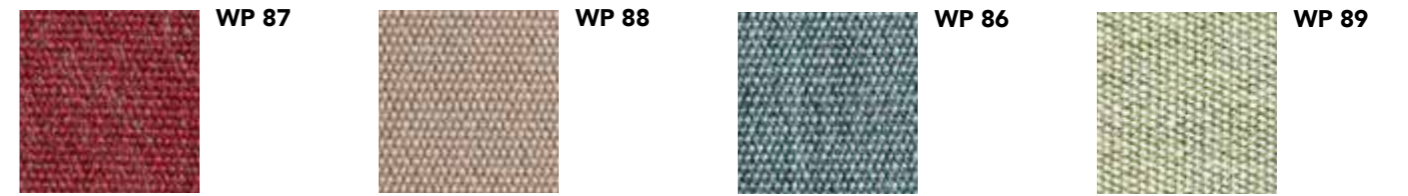

ACRYLIC ACRILICO WATER REPELLENT STAIN RESISTANT IDROREPELENTE ANTIMACCHIA



FABRIC TESSUTO



LINEN LINO CERTIFIED AND CAM COMPLIANT CERTIFICATO E CONFORME AI CAM



CUSTOMER OWN FABRIC TESSUTO CLIENTE





**FABRICS FOR FIXED AND MOBILE CUSHIONS FOR DROP, GIULIA, GLENDA, IGLOO, ISY, MISS B**  
 TESSUTI PER CUSCINI FISSI E DA APPOGGIO PER DROP, GIULIA, GLENDA, IGLOO, ISY, MISS B

**FABRIC TESSUTO** .....

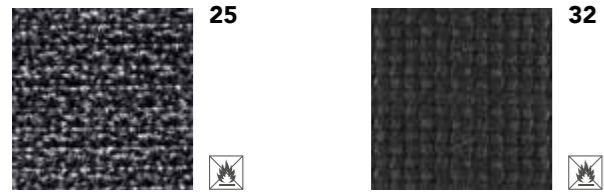

**PANAMA COTTON COTONE PANAMA**



**FABRICS FOR OUTDOOR CUSHIONS FOR LISA SOFA, SWING, LOUNGE, DRESS\_CODE**  
 TESSUTO CUSCINI OUTDOOR PER LISA SOFA, SWING, LOUNGE, DRESS\_CODE

**ACRYLIC ACRILICO**  WATER-REPELLENT STAIN RESISTANT *IDROPELLENTE ANTIMACCHIA* .....



**FABRICS CLOTHS DRESS\_CODE TESSUTI TELI DRESS\_CODE**

**ACRYLIC ACRILICO** WATER-REPELLENT STAIN RESISTANT *IDROPELLENTE ANTIMACCHIA* .....



**FABRICS FOR OUTDOOR CUSHIONS FOR SI-SI, SI-SI BARCODE, SI-SI DOTS**  
 TESSUTO CUSCINI OUTDOOR PER SI-SI, SI-SI BARCODE, SI-SI DOTS

**ACRYLIC DRALON® ACRILICO DRALON®** WATER-REPELLENT *IDROPELLENTE* .....



**FABRICS FOR OUTDOOR CUSHIONS FOR SUMMER CHAIR AND ARMCHAIR**  
 TESSUTO CUSCINI OUTDOOR PER SEDIA E POLTRONA SUMMER

**ACRYLIC ACRILICO** WATER-REPELLENT STAIN RESISTANT *IDROPELLENTE ANTIMACCHIA* .....



**SYNTHETIC MATERIALS MATERIALI SINTETICI**

**SYNTHETIC FABRIC, BREATHABLE, WATER-REPELLENT TESSUTO SINTETICO TRASPIRANTE IDROPELLENTE** .....

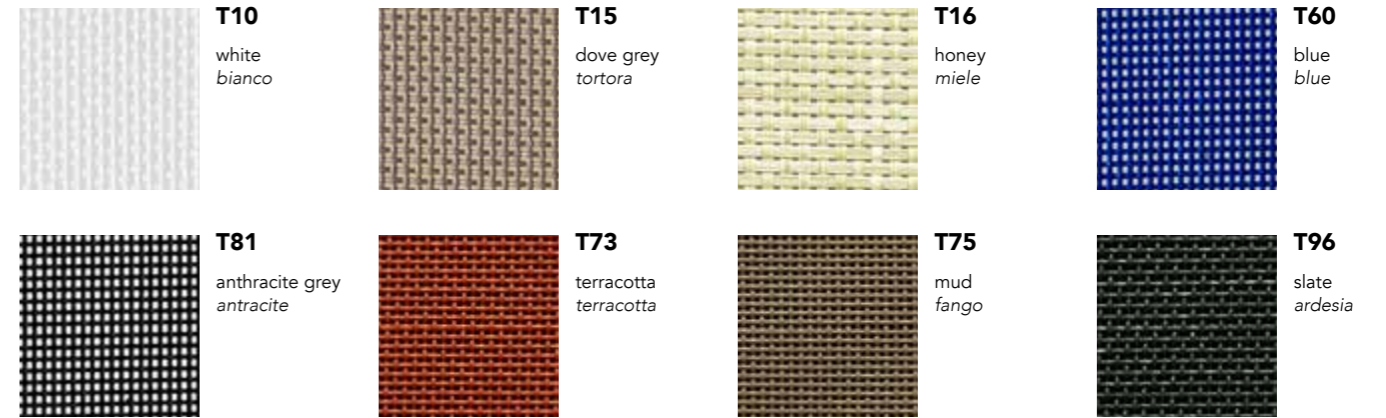

**NAUTICAL ROPE CORDA NAUTICA** .....



100% recyclable polyester, dope-dyed, non-toxic, resistant and easy to maintain.  
 100% poliestere riciclabile, tinto in pasta, atossico, resistente e di facile manutenzione.

**WOVEN EXTRUDED PVC WITH NYLON WIRES CORDA IN ESTRUSO DI PVC CON ANIME IN NYLON** .....

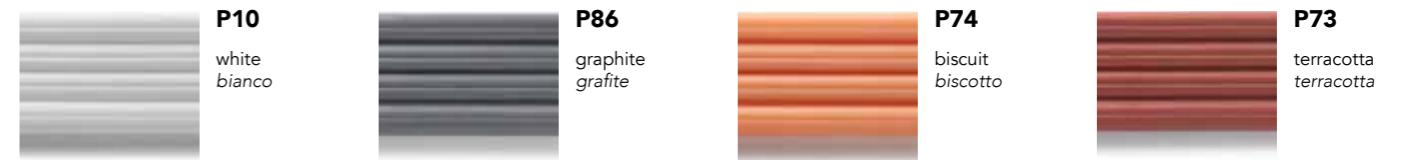



**S•CAB headquarters/sede** — Coccaglio (BS) Italy

**S•CAB** — Coccaglio (BS) Italy

**S•CAB** — Rudiano (BS) Italy

**HEADQUARTERS / SEDE**

Via G. Monauni, 32/12  
25030 Coccaglio (BS) - Italy  
Ph. +39 030 7718.611

**DIVISIONE COMMERCIALE ITALIA**

Ph. +39 030 7718.760/765/770/775  
italia@s-cab.it

**EXPORT DEPARTMENT**

Ph. +39 030 7718.715/720/725/726  
export@s-cab.it

**S•CAB reserves the right to make alterations to its product range without giving prior notice.** Measurements and colours shown are approximatives. The printed colours/fabrics may differ slightly from the actual ones for photo and print technical reasons. The reproduction of the photographic material contained in the present catalogue is strictly forbidden. All original S•CAB models are covered by shape patents and exclusive rights.

**S•CAB si riserva il diritto di modificare, senza preavviso, la propria produzione.**

*Misure e colori sono puramente indicativi. Per ragioni tecniche di stampa o di fotografia i colori/tessuti stampati possono differire lievemente da quelli reali. È tassativamente vietato riprodurre senza autorizzazione il materiale fotografico contenuto nel presente catalogo. Ogni modello originale S•CAB è protetto da brevetti di forma e da diritti di esclusiva.*

**Art direction:** Publifarm  
**Photo credits** Odeon  
Chris Abatzis  
Vertumn  
Luca Argenton  
Paolo Sacchi  
Gotico Fotografia, Simona Ciaccia  
FTfoto  
Barbara Corsico  
Luna Pérez  
Fabio Cattabiani  
Jürgen Eheim  
Paterakis Vangelis  
**Edition:** 2022

# S·CAB

