

SALOTTI PER ESTERNO / *OUTDOOR LIVING*

Pag. 14-15



Pag. 24-25



Pag. 18-19



Pag. 20-21



Pag. 22-23



Pag. 16-17



Pag. 26



Pag. 27



LETTINI / *SUNBED*

Pag. 28-29



Pag. 30-31



Pag. 32



TAVOLI DA GIARDINO / *GARDEN TABLES*

Pag. 34-35



Pag. 38-39



Pag. 40-41

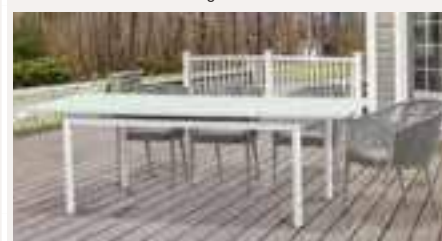

Pag. 42-43



Pag. 44-45



Pag. 46-47



SEDIE E POLTRONCINE PER ESTERNO / *OUTDOOR CHAIRS AND ARMCHAIRS*

<p>Pag. 48</p>  <p>1636 - E71</p>	<p>Pag. 48</p>  <p>1635 - E70</p>	<p>Pag. 49</p>  <p>1637 - E72</p>	<p>Pag. 50</p>  <p>1790 - MB1</p>	<p>Pag. 52</p>  <p>1788 - MB2</p>	<p>Pag. 53</p>  <p>440 - P753</p>	<p>Pag. 54</p>  <p>1910 - RD09</p>	<p>Pag. 55</p>  <p>1581 - MC039</p>
<p>Pag. 56</p>  <p>1670 - UE0W</p>	<p>Pag. 56</p>  <p>1699 - UE03</p>	<p>Pag. 58</p>  <p>809 - C78</p>	<p>Pag. 58</p>  <p>810 - C78A</p>	<p>Pag. 58</p>  <p>996 - C22</p>	<p>Pag. 60</p>  <p>051 - MC1415</p>	<p>Pag. 61</p>  <p>1910 - RD09</p>	<p>Pag. 61</p>  <p>1640 - SU8</p>
<p>Pag. 62</p>  <p>1902 - RD01</p>	<p>Pag. 66</p>  <p>073 - ZL76</p>	<p>Pag. 66</p>  <p>075 - ZL77</p>	<p>Pag. 68</p>  <p>451 - P82</p>	<p>Pag. 68</p>  <p>452 - P82A</p>	<p>Pag. 70</p>  <p>1842 - F28</p>	<p>Pag. 73</p>  <p>441 - P79</p>	<p>Pag. 76</p>  <p>1823 - 317A</p>
<p>Pag. 77</p>  <p>1824 - 320A</p>	<p>Pag. 78</p>  <p>462 - S03</p>	<p>Pag. 79</p>  <p>463 - S03A</p>	<p>Pag. 80</p>  <p>1501 - 9D</p>	<p>Pag. 81</p>  <p>1502 - 9E</p>	<p>Pag. 82</p>  <p>1054 - LIB</p>	<p>Pag. 84</p>  <p>1156 - WAM</p>	<p>Pag. 87</p>  <p>449 - F18</p>
<p>Pag. 88</p>  <p>1893 - DH01</p>	<p>Pag. 89</p>  <p>998 - SH15</p>	<p>Pag. 90</p>  <p>1480 - XH3</p>	<p>Pag. 93</p>  <p>725 - Y19</p>	<p>Pag. 97</p>  <p>1483 - A11</p>	<p>Pag. 100</p>  <p>1277 - M25</p>	<p>Pag. 100</p>  <p>802 - Y012</p>	<p>Pag. 101</p>  <p>819 - U13</p>
<p>Pag. 101</p>  <p>818 - U12</p>	<p>Pag. 102</p>  <p>498 - L80801</p>	<p>Pag. 102</p>  <p>499 - L80804</p>	<p>Pag. 106</p>  <p>718 - MCR138</p>	<p>Pag. 106</p>  <p>719 - MCR139</p>	<p>Pag. 107</p>  <p>535 - AM12</p>	<p>Pag. 107</p>  <p>536 - AM13</p>	<p>Pag. 108</p>  <p>062 - AM10</p>

Pag. 108  063 - AM09	Pag. 109  060 - AM03	Pag. 109  056 - AM02	Pag. 109  055 - AM01	Pag. 110  038 - ALW05	Pag. 110  040 - ALW07	Pag. 110  043 - ALW12	Pag. 112  005 - ALL05
---	---	---	---	--	--	--	--









Pag. 112  007 - ALL07	Pag. 112  454 - ALL33	Pag. 113  713 - ALB07	Pag. 113  714 - ALB01				
--	--	--	--	--	--	--	--

















































SEDIE E POLTRONCINE PER INTERNO / INDOOR CHAIRS AND ARMCHAIRS

Pag. 118  1904 - RD03	Pag. 122  469 - G1	Pag. 123  470 - GA2	Pag. 124  1900 - DC01	Pag. 124  1901 - DC02	Pag. 125  467 - DC92B	Pag. 126  468 - DC91	Pag. 128  1652 - J02
---	--	---	---	---	---	--	--

Pag. 132  1761 - JB1	Pag. 138  1863 - FR02	Pag. 140  1865 - FR04	Pag. 142  1938 - UK01	Pag. 143  1939 - UK02	Pag. 144  1615 - TOP8	Pag. 148  1954 - E14	Pag. 150  539 - AV01
---	--	--	--	--	--	---	---











Pag. 152  1528 - T07	Pag. 153  1693 - F450	Pag. 154  1438 - C50W	Pag. 155  1439 - C50P	Pag. 156  732 - MG01	Pag. 157  182 - XR3	Pag. 157  183 - XR4	Pag. 158  1927 - TD03
---	--	--	--	---	--	--	--

Pag. 160  1803 - DC81	Pag. 160  1802 - DC80	Pag. 161  1748 - XH9	Pag. 162  821 - RF49C	Pag. 163  825 - RF49P	Pag. 164  949 - F400	Pag. 165  948 - F503	Pag. 166  1451 - 7BD
--	--	---	--	--	---	---	---

























<p>Pag. 166</p>  <p>1456 - 30D</p>	<p>Pag. 167</p>  <p>1485 - F50</p>	<p>Pag. 171</p>  <p>1524 - D22</p>	<p>Pag. 171</p>  <p>1523 - D23</p>	<p>Pag. 172</p>  <p>542 - BX01</p>	<p>Pag. 172</p>  <p>543 - BX02</p>	<p>Pag. 173</p>  <p>1193 - PW72</p>	<p>Pag. 174</p>  <p>1335 - W58</p>
<p>Pag. 178</p>  <p>1586 - YG100</p>	<p>Pag. 178</p>  <p>541 - YG103</p>	<p>Pag. 179</p>  <p>1587 - YG101</p>	<p>Pag. 180</p>  <p>1488 - YG93</p>	<p>Pag. 181</p>  <p>1626 - EV10</p>	<p>Pag. 182</p>  <p>465 - AP34</p>	<p>Pag. 183</p>  <p>464 - V11</p>	<p>Pag. 184</p>  <p>1525 - D24</p>
<p>Pag. 186</p>  <p>1322 - Z87</p>	<p>Pag. 188</p>  <p>1846 - SI02</p>	<p>Pag. 189</p>  <p>1042 - C25F</p>	<p>Pag. 189</p>  <p>1041 - C25</p>	<p>Pag. 190</p>  <p>1848 - SI04</p>	<p>Pag. 192</p>  <p>1037 - G03</p>	<p>Pag. 193</p>  <p>1036 - G02</p>	<p>Pag. 198</p>  <p>1188 - HT36</p>
<p>Pag. 200</p>  <p>1722 - SU22</p>	<p>Pag. 200</p>  <p>1721 - SU21</p>	<p>Pag. 201</p>  <p>1186 - HT35</p>	<p>Pag. 202</p>  <p>466 - TD90</p>	<p>Pag. 203</p>  <p>1747 - XH2</p>	<p>Pag. 203</p>  <p>1777 - M18</p>	<p>Pag. 203</p>  <p>1895 - DH02</p>	<p>Pag. 205</p>  <p>1781 - MB2</p>
<p>Pag. 210</p>  <p>976 - ET53</p>	<p>Pag. 211</p>  <p>978 - EM53W</p>	<p>Pag. 215</p>  <p>1427 - 01N</p>	<p>Pag. 218</p>  <p>1100 - M51</p>	<p>Pag. 220</p>  <p>968 - MC001D</p>	<p>Pag. 220</p>  <p>1077 - MC001DW</p>	<p>Pag. 223</p>  <p>969 - MC001T</p>	<p>Pag. 223</p>  <p>1066 - MC001TW</p>
<p>Pag. 226</p>  <p>1674 - PA2</p>	<p>Pag. 227</p>  <p>1912 - SN01</p>	<p>Pag. 228</p>  <p>544 - DC95</p>	<p>Pag. 229</p>  <p>083 - AR100</p>	<p>Pag. 229</p>  <p>084 - AR38</p>	<p>Pag. 230</p>  <p>1589 - YG103</p>	<p>Pag. 231</p>  <p>1486 - YG91</p>	<p>Pag. 232</p>  <p>074 - CT123</p>

Pag. 232  587 - AM01	Pag. 233  1149 - 076	Pag. 234  889 - PC492	Pag. 235  1259 - M0120C	Pag. 249  593 - C2842		
---	---	--	--	--	--	--







































SGABELLI PER ESTERNO / OUTDOOR BAR STOOLS

Pag. 51  1791 - MY1	Pag. 56  1698 - UE02	Pag. 64  1903 - RD02	Pag. 67  077 - ZL79	Pag. 69  461 - P84	Pag. 71  1841 - F80	Pag. 73  448 - P81	Pag. 95  1897 - DH04
Pag. 110  042 - ALW09	Pag. 112  010 - ALL09	Pag. 113  734 - ALLB02					

SGABELLI PER INTERNO / INDOOR BAR STOOLS

Pag. 120  1905 - RD04	Pag. 122  471 - GA3	Pag. 123  474 - GA4	Pag. 130  1764 - JA6G	Pag. 134  1763 - JA6	Pag. 139  080 - FR25	Pag. 141  081 - FR26	Pag. 144  1617 - TOP10
Pag. 151  540 - AV012	Pag. 159  1928 - TD04	Pag. 161  171 - XH11	Pag. 169  1007 - F600	Pag. 190  1847 - SI03	Pag. 194  1258 - G04L	Pag. 194  1038 - G04	Pag. 198  1321 - HT37
Pag. 201  1440 - HT38	Pag. 205  1785 - M58	Pag. 206  1779 - M51	Pag. 206  1778 - M50	Pag. 206  1780 - M52	Pag. 207  1417 - BM37	Pag. 208  1914 - CD02	Pag. 208  1915 - CD03

Sedie & tavoli

Pag. 208  1916 - CD04	Pag. 208  1813 - CD01	Pag. 209  1977 - CD05	Pag. 212  1084 - BT18	Pag. 213  955 - MC012	Pag. 213  1083 - MC012W	Pag. 213  1082 - BT503W	Pag. 213  977 - BT503
Pag. 215  1496 - BT04	Pag. 216  1832 - BS18	Pag. 217  1295 - BT03	Pag. 221  1062 - MC012DT	Pag. 221  1061 - MC012D	Pag. 221  1263 - 009T	Pag. 222  1079 - MC012DTW	Pag. 222  1078 - MC012DW
Pag. 224  966 - MC012T	Pag. 224  1060 - MC012PT	Pag. 224  1264 - 010T	Pag. 225  1068 - MC012PTW	Pag. 225  1067 - MC012TW	Pag. 228  545 - DC96	Pag. 234  591 - BX10	Pag. 237  1497 - K31
Pag. 238  1500 - K32	Pag. 239  1627 - EV36	Pag. 239  1639 - EV37	Pag. 240  599 - DP3	Pag. 241  597 - CC1	Pag. 242  932 - K38	Pag. 243  1630 - EV23	Pag. 244  933 - K08
Pag. 245  997 - K3001	Pag. 246  1031 - 795	Pag. 246  1113 - BY035	Pag. 247  604 - XH9	Pag. 247  602 - XH2	Pag. 248  245 - B030		

POLTRONE UFFICIO / OFFICE ARMCHAIRS

Pag. 250  605 - ZWH1	Pag. 250  609 - ZW2	Pag. 251  629 - ZW5	Pag. 252  610 - ZWH3	Pag. 252  612 - ZW4	Pag. 254  1237 - HM2	Pag. 254  1238 - MM2	Pag. 254  1239 - VM2
---	--	--	---	--	---	---	---

Pag. 255  1234 - HL1	Pag. 255  1235 - ML1	Pag. 255  1236 - VL1	Pag. 256  529 - W81	Pag. 257  671 - W03	Pag. 258  1628 - EV11	Pag. 259  1491 - YG98	Pag. 261  1126 - K03
---	---	---	--	--	--	--	---





POLTRONE E DIVANI PER INTERNO / INDOOR SOFAS

Pag. 144  1616 - TOP9	Pag. 262  620 - X17PS	Pag. 263  619 - X17D2S	Pag. 264  618 - X17D3S
--	--	--	---

Pag. 265  1797 - HKP2	Pag. 266  1604 - 06S	Pag. 267  1605 - 06P	Pag. 268  1603 - 06T	Pag. 269  1774 - S03
---	--	--	--	--

Pag. 270  1659 - DA1	Pag. 271  050 - DA2	Pag. 271  733 - DA3	Pag. 272  1520 - S8V	Pag. 278  1713 - DK70	Pag. 279  1712 - DK65
---	--	--	--	--	--

PANCHE PER INTERNO / INDOOR BENCHES

Pag. 136  1760 - S50	Pag. 136  1767 - S49	Pag. 280 	Pag. 281 
---	---	--	---

Pag. 282 	Pag. 283 	Pag. 284 
---	--	---

TAVOLINI E TAVOLI PER ESTERNO / OUTDOOR COFFEE TABLES AND TABLES

Pag. 33 1729 - CL7	Pag. 33 1555 - T12	Pag. 33 1557 - T13	Pag. 39 1810 - SD85	Pag. 41 1810 - SD85
---------------------------	---------------------------	---------------------------	----------------------------	----------------------------

Pag. 43 1807 - SD80	Pag. 45 1807 - SD80	Pag. 47 1807 - SD80	Pag. 49 1806 - ST40
----------------------------	----------------------------	----------------------------	----------------------------

Pag. 57 1568 - QT60	Pag. 57 1697 - VEC1 SET	Pag. 59 128 - MA01A	Pag. 59 130 - MA09A	Pag. 59 1526 - HY18	Pag. 74 1735 - Y70
----------------------------	--------------------------------	----------------------------	----------------------------	----------------------------	---------------------------

Pag. 74 1734 - Y60	Pag. 75 071 - DH01	Pag. 75 072 - DH02	Pag. 80 1415 - TB712	Pag. 81 177 - TB718
---------------------------	---------------------------	---------------------------	-----------------------------	----------------------------

Pag. 103 560 - CTS0022	Pag. 103 561 - MCQ 80	Pag. 104 239 - S16	Pag. 104 1044 - S15	Pag. 105 566 - 0624T SET	Pag. 111 109 - MTW006A	Pag. 111 106 - MTW001
-------------------------------	------------------------------	---------------------------	----------------------------	---------------------------------	-------------------------------	------------------------------

Pag. 111 675 - MTW013A	Pag. 111 678 - MTW011A	Pag. 114 097 - MTA013A	Pag. 114 100 - MTA011A	Pag. 114 093 - MTA007A	Pag. 115 096 - MTA010	Pag. 115 102 - MTA016K
-------------------------------	-------------------------------	-------------------------------	-------------------------------	-------------------------------	------------------------------	-------------------------------

TAVOLINI E TAVOLI PER INTERNO / INDOOR COFFEE TABLES AND TABLES

Pag. 205  1784 - MT14	Pag. 205  1786 - MT15	Pag. 207  1800 - MT48	Pag. 211  1265 - 70W	Pag. 214  1266 - CT60	Pag. 219  1575 - 36WA	Pag. 220  956 - 36D
--	--	--	---	---	--	--

Pag. 223  1262 - 236D	Pag. 225  1267 - GT24	Pag. 227  715 - SN02	Pag. 241  594 - CW1	Pag. 258  666 - CW13	Pag. 264  1653 - B01T	Pag. 273  1678 - SE10	Pag. 273  1681 - SE02
---	--	---	--	---	--	--	--

Pag. 274  685 - WD5	Pag. 274  683 - WD4	Pag. 274  687 - WD7	Pag. 274  686 - WD	Pag. 275  682 - WD3	Pag. 276  673 - WD1	Pag. 276  674 - WD2
---	---	---	--	---	---	---

Pag. 277  1611 - TOP4	Pag. 277  1619 - TOP12	Pag. 286  1922 - ZL02	Pag. 290  537 - CS205	Pag. 290  538 - CS206	Pag. 290  1840 - BT2G
--	---	--	--	--	--

Pag. 291  1770 - F39G	Pag. 291  1768 - F43G	Pag. 292  938 - K54	Pag. 293  841 - RF22	Pag. 296  1665 - TF22
--	--	--	--	--

Pag. 298  1737 - DT45	Pag. 300  1694 - DE93T	Pag. 302  1442 - A58	Pag. 306  1594 - DE86T
---	---	--	---

Pag. 308



1608 - TOP1

Pag. 310



1609 - TOP2

Pag. 312



1324 - A75

Pag. 314



1445 - A75G

Pag. 316



1801 - MT49

Pag. 318

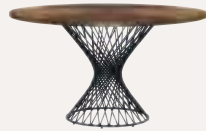

1677 - MIT10

Pag. 320

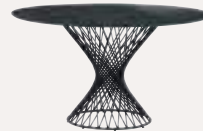

1676 - MIT67

Pag. 321

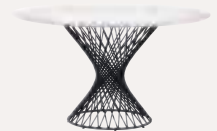

1676 - MIT67

Pag. 322



1450 - 28DT

Pag. 325



1457 - 65DT

Pag. 327



1460 - 78DT

Pag. 329



1466 - 73DTM

Pag. 331



1467 - 73DTN

BASI TAVOLI PER INTERNO / INDOOR TABLE BASES

Pag. 334



1648 - EG3

Pag. 334



1647 - EC1

Pag. 334



1839 - EP1

Pag. 334



1839 - EP1

Pag. 335



980 - TB015S

Pag. 335



988 - TB015V

Pag. 336



530 - LX188

Pag. 337



517 - LX191

Pag. 338



506 - LX194

Pag. 339



500 - LX192

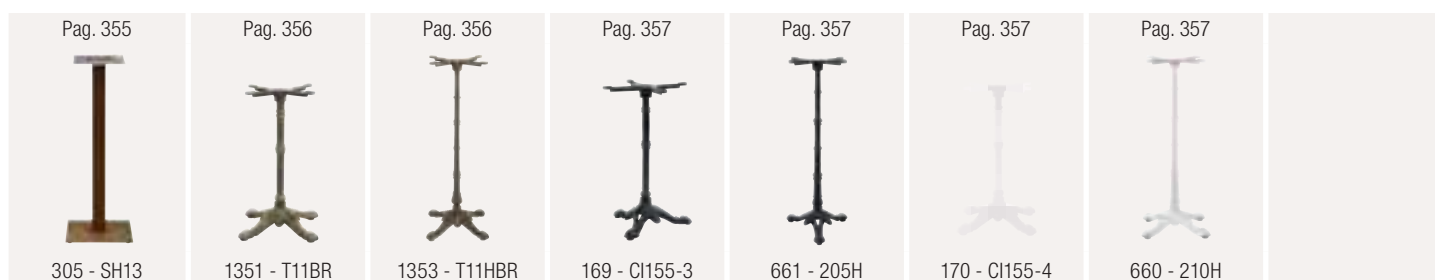

BASI TAVOLI PER ESTERNO / OUTDOOR TABLE BASES

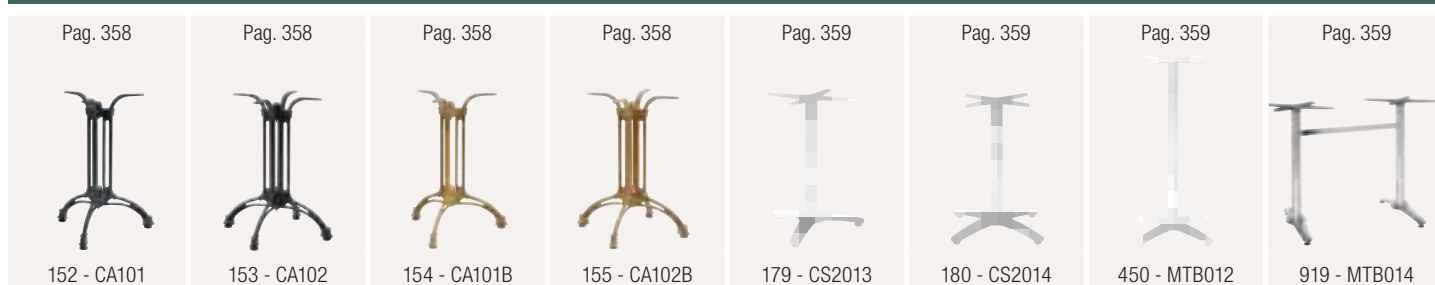

Sedie & tavoli

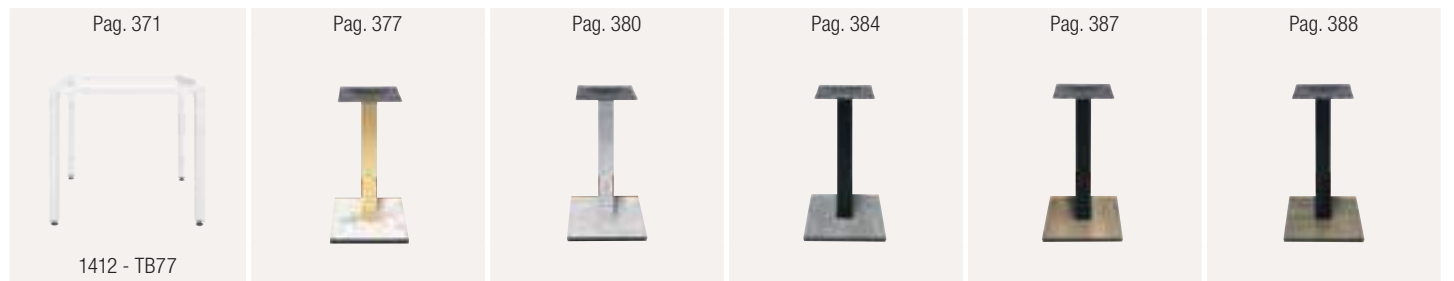
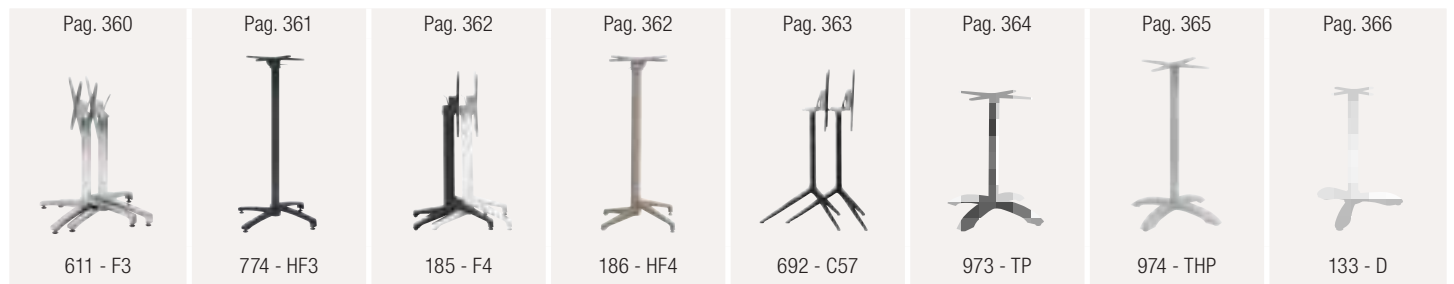

PIANI IN STRATIFICATO HPL / HPL TOPS - pag. 372-375

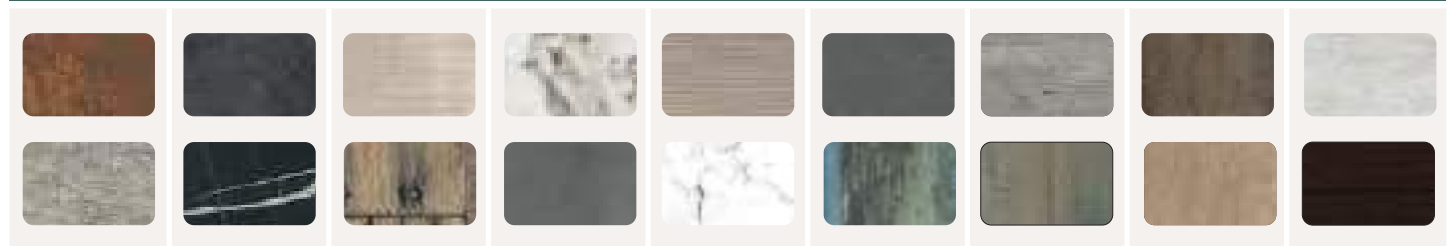

PIANI PER ESTERNO "WERZALIT" / OUTDOOR TOPS "WERZALIT" - pag. 390-393

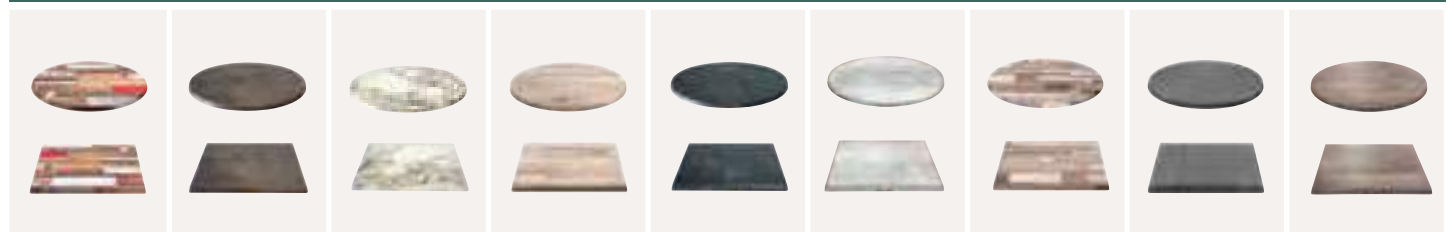

PIANI PER ESTERNO / OUTDOOR TOPS - pag. 393-395

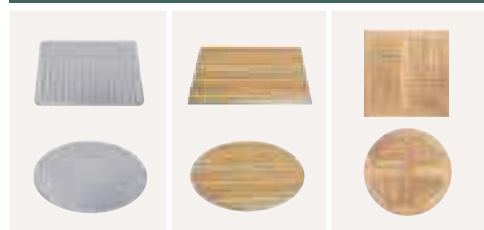

PIANI IN LAMINATO / LAMINATES TOPS - pag. 397-399

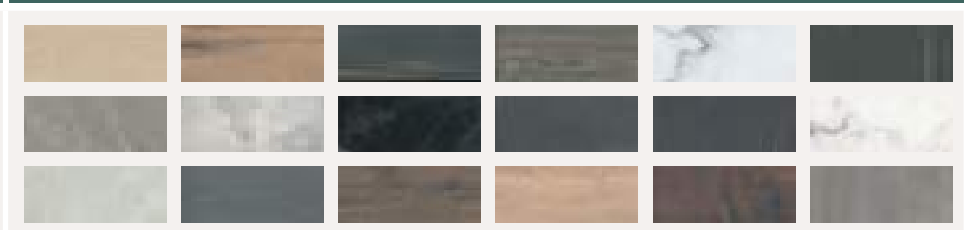



Esterno

Outdoor



375 - 5T1
(L75 x P80 x H69 cm) KD



379 - 5T2
(L190 x P80 x H69 cm) KD



380 - 5T3
(L150 x P80 x H69 cm) KD



381 - 5T4
(L75 x P65 x H42 cm) KD



382 - 5TT
(L63 x P110 x H34 cm) KD



383 - 5GT
(L66 x P120 x H34 cm) KD

Struttura in alluminio verniciato e teak, sedute e schienali imbottiti, tessuto idrorepellente, piano tavolino in teak o ceramica

Powder coated aluminum and teak frame, padded seat and backrest outdoor fabric, teak or ceramic coffee table top





1795 - SF1 SET

Struttura in alluminio verniciato, schienale in corda, cuscini idrorepellenti, tavolino in alluminio verniciato, piano in vetro temperato
Powder coated aluminum frame, backrest in rope, outdoor fabric cushions covering, powder coated aluminum coffee table, tempered glass top

- POLTRONA *ARMCHAIR*
(L74 x P70 x H73 cm) KD
- DIVANO *SOFA*
(L143 x P70 x H73 cm) KD
- TAVOLINO *COFFEE TABLE*
(L90 x P60 x H43 cm)







1296 - BAR1 SET

Struttura in alluminio verniciato,
rivestimento in piattina di polietilene,
cuscini idrorepellenti,
tavolino in alluminio verniciato,
piano in teak

*Powder coated aluminum frame,
polyethylene strap covering,
outdoor fabric cushions covering,
powder coated aluminum coffee table,
teak top*

- POLTRONA *ARMCHAIR*
(L60 x P65 x H81 cm)
- DIVANO *SOFA*
(L130 x P65 x H81 cm)
- TAVOLINO *COFFEE TABLE*
(L110 x P70 x H45 cm)







438 - F850 SET

Struttura in metallo verniciato,
scocca in polipropilene,
cuscini idrorepellenti,
tavolini verniciati in metallo

*Powder coated metal frame,
polypropylene shell,
outdoor fabric cushions covering,
powder coated metal coffee table*

- POLTRONA *ARMCHAIR*
(L74 x P62 x H67 cm) KD
- DIVANO *SOFA*
(L120 x P62 x H67 cm) KD
- TAVOLINO *COFFEE TABLE*
(Ø 50 x H45 cm) KD
- TAVOLINO *COFFEE TABLE*
(Ø 60 x H40 cm) KD





- DIVANO *SOFA*
(L147 x P78 x H78 cm)
- POLTRONA *ARMCHAIR*
(L81 x P78 x H78 cm)
- TAVOLINO *COFFEE TABLE*
(L120 x P60 x H40 cm)



408 - RBTG SET

Struttura in alluminio verniciato, braccioli in teak, cuscini idrorepellenti, tavolino in alluminio verniciato

Powder coated aluminum frame, teak arms, outdoor fabric cushions covering, powder coated aluminum coffee table







1512 - A4P SET

Struttura in alluminio verniciato, cuscini in tessuto, tavolino in alluminio verniciato, piano in vetro temperato
Powder coated aluminum frame, fabric cushions covering, powder coated aluminum coffee table, tempered glass top

POLTRONA *ARMCHAIR*
(L75 x P71 x H64 cm)

DIVANO *SOFA*
(L162 x P71 x H64 cm)

TAVOLINO *COFFEE TABLE*
(L100 x P55 x H45 cm)



1804 - H70

Struttura in alluminio verniciato, materassini rivestimento in tessuto, spessore 10 cm, teli in textilene

Powder coated aluminum frame, fabric mats covering, thickness 10 cm, sides with textylene

(L200 x P200 x H200 cm) KD



□ DONDOLO *ROCKING*

406 - 05P

Struttura in alluminio verniciato,
scocca in teak, cuscini in tessuto

*Powder coated aluminum frame,
teak shell, fabric cushions*

(L200 x P123 x H195 cm) KD



W

T



389 - 1DT
(L194 x P66 cm)



Struttura in alluminio e teak, tessuto imbottito
Aluminum and teak frame, padded fabric







LETTINO *SUN BED*

1554 - A12

Struttura in alluminio verniciato,
tessuto in textilene, ruote posteriori

*Powder coated aluminum frame,
textilene fabric, rear wheels*

(L194 x P67 cm)



W T

TAVOLINO *COFFEE TABLE* - pg. 33

1555 - T12



439 - P78

Struttura in alluminio verniciato e polipropilene, tessuto in textilene, ruote posteriori

Powder coated aluminum and polypropylene frame, textilene fabric, rear wheels

(L194 x P70 x H88 cm)





1729 - CL7

Struttura in metallo verniciato

Powder coated metal frame

(Ø40 x H41 cm)



1555 - T12

Struttura in alluminio verniciato

Powder coated aluminum frame

(L40 x P40 x H33 cm)



1557 - T13

Struttura in alluminio verniciato

Powder coated aluminum frame

(Ø45 x H33 cm)





□ POLTRONCINA *ARMCHAIR*
384 - C1P

Struttura in teak, tessuto idrorepellente
Teak frame, padded outdoor fabric

h A h h KD
88cm 57cm 48cm 46cm





□ TAVOLO *TABLE*
385 - C2T
Struttura in teak, piano in ceramica
Teak frame, ceramic top
(L180 x P90 x H74 cm) KD





POLTRONCINA *ARMCHAIR*
384 - C1P

Struttura in teak, tessuto idrorepellente
Teak frame, padded outdoor fabric

    KD
88cm 57cm 48cm 46cm



TAVOLO QUADRATO *SQUARE TABLE*
386 - C3T
(L89 x P89 x H74 cm) KD

TAVOLO TRIANGOLARE *TRIANGULAR TABLE*
387 - C4T
(L110 x P110 x H74 cm) KD

TAVOLO ROTONDO *ROUND TABLE*
388 - C5T
(Ø 89 x H74 cm) KD

Struttura in teak, piano in ceramica
Teak frame, ceramic top



□ TAVOLO *TABLE*
1810 - SD 85

Struttura in alluminio verniciato, piano
allungabile in vetro temperato antigraffio
*Powder coated aluminum frame, tempered
and extension in scratchproof glass*
(L180/240 x P100 x H76 cm) KD



W T

□ POLTRONCINA *ARMCHAIR* - pg. 48
1635 - E70



□ POLTRONCINA *ARMCHAIR* - pg. 48
1636 - E71







□ TAVOLO *TABLE*

1810 - SD85

Struttura in alluminio verniciato, piano
allungabile in vetro temperato antigraffio

*Powder coated aluminum frame, tempered
and extension in scratchproof glass*

(L180/240 x P100 x H76 cm) KD



W T

□ POLTRONCINA *ARMCHAIR* - pg. 48

1635 - E70





- TAVOLO *TABLE*
1807 - SD80

Struttura in alluminio verniciato, piano allungabile in vetro temperato antigraffio

Powder coated aluminum frame, top and extension in tempered scratchproof glass

(L140/180 x P75 x H76 cm) KD



- SEDIA *CHAIR* - pg. 66
073 - ZL76

- POLTRONCINA *ARMCHAIR* - pg. 66
075 - ZL77









TAVOLO *TABLE*

1807 - SD80

Struttura in alluminio verniciato, piano
allungabile in vetro temperato antigraffio

*Powder coated aluminum frame, top and
extension in tempered scratchproof glass*

(L140/180 x P75 x H76 cm) KD



W T AN

SEDIA *CHAIR* - pg. 66

073 - ZL76

POLTRONCINA *ARMCHAIR* - pg. 66

075 - ZL77





TAVOLO *TABLE*

1807 - SD80

Struttura in alluminio verniciato, piano allungabile in vetro temperato antigraffio

Powder coated aluminum frame, top and extension in tempered scratchproof glass

(L140/180 x P75 x H76 cm) KD



W T AN

SEDIA *CHAIR* - pg. 66

073 - ZL76

POLTRONCINA *ARMCHAIR* - pg. 66

075 - ZL77







1636 - E71

Struttura in alluminio verniciato, seduta e schienale in piattina di polietilene

Powder coated aluminum seat and backrest in polyethylene strap



1635 - E70

Struttura in alluminio verniciato, rivestimento in piattina di polietilene, cuscino idrorepellente

Powder coated aluminum frame, polyethylene strap covering, outdoor fabric pad covering

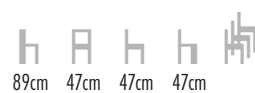



POLTRONCINA *ARMCHAIR*
1637 - E72

Struttura in alluminio verniciato, seduta in textilene,
schienale in corda

*Powder coated aluminum frame, textylene seat,
backrest in rope*

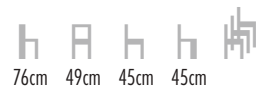

TAVOLINO *COFFEE TABLE*

Struttura in alluminio verniciato

Powder coated aluminum frame

1806 - ST40

(Ø 55 x H53 cm)

1805 - ST30

(Ø 55 x H45 cm)





SEDIA CHAIR
1790 - MB1

Struttura in alluminio verniciato,
rivestimento in textilene

*Powder coated aluminum frame,
textilene covering*

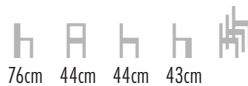

76cm 44cm 44cm 43cm

BASE TAVOLO TABLE BASE
611 - F3

struttura / frame



W AN



SGABELLO *BAR STOOL*
1791 - MY1

Struttura in alluminio verniciato,
rivestimento in textilene

*Powder coated aluminum frame,
textilene covering*

 109cm 41cm 40cm 78cm

BASE TAVOLO *TABLE BASE*
774 - HF3

struttura / *frame*

W AN



SEDIA CHAIR
1788 - MB2

Struttura in alluminio verniciato,
schienale in corda, cuscino idrorepellente

*Powder coated aluminum frame,
backrest in rope, outdoor fabric pad covering*

 77cm 43cm 44cm 46cm

BASE TAVOLO TABLE BASE
611 - F3

struttura / frame

W AN



440 - P753

Struttura in metallo, scocca in polipropilene con cuscino

Powder coated metal frame, polypropylene shell with pad

h A h h KD
80cm 48cm 48cm 46cm





W N T Y



1910 - RD09

Struttura in metallo verniciato,
cuscino in ecopelle

*Powder coated metal frame,
synthetic leather pad*





 KD
 78cm 43cm 40cm 45cm





 W N SE





1581 - MC039

Struttura in alluminio verniciato
Powder coated aluminum frame.

 86cm 39cm 41cm 44cm

 W AN SE V T



1670 - UEOW



1699 - UE03



Struttura in metallo verniciato

Powder coated metal frame



W AN T

1698 - UE02





1568 - QT60
L60 x P60 x H75 cm

1569 - QT70
L70 x P70 x H75 cm

1570 - QT80
L80 x P80 x H75 cm

1696 - HQT70
L70 x P70 x H110 cm

Struttura autolivellante in metallo verniciato
Powder coated metal frame



W AN T



1697 - VEC1 SET
Tavolo + 4 sgabelli / *Table + 4 barstools*

TAVOLO *TABLE*
L75 x P75 x H110 cm

SGABELLO *BAR STOOL*

77cm 32cm 32cm



809 - C78







90cm 42cm 48cm 44,5cm



810 - C78A











90cm 42cm 48cm 44,5cm



996 - C22

90cm 45cm 44cm 45cm

Struttura in metallo verniciato
Powder coated metal frame



128 - MA01A (Ø60 x H72 cm) KD

129 - MA01B (Ø70 x H72 cm) KD



Struttura in metallo verniciato
Powder coated metal frame

130 - MA09A (70 x 70 x H72 cm) KD

131 - MA09B (80 x 80 x H72 cm) KD



1526 - HY18 (70 x 70 x 74 cm)

1508 - HY17 (80 x 80 x 74 cm)



Struttura in metallo verniciato
Powder coated metal frame





POLTRONCINA *ARMCHAIR*
051 - MC1415

Struttura pieghevole
in alluminio verniciato,
braccioli in legno,
tessuto in textilene

*Folding aluminum frame,
powder coating,
wood arms,
seat and backrest in textilene*

91cm 43cm 44cm 47cm

W G

PIANO IN TEAK *TEAK TOP*
1221 - TGF2600

BASE *BASE*
1413 - TB78



BASE TAVOLO *TABLE BASE*
177 - TB718

PIANO *TOP*
291 - BST180 - KARARA WHITE



POLTRONCINA *ARMCHAIR*
1641 - SU8A



SEDIA *CHAIR*
1640 - SU8



Struttura in alluminio verniciato, seduta e schienale in textylene

Powder coated aluminum frame, seat and backrest in textylene

struttura / frame



W T



by Rossanese

1902 - RD01

Struttura in metallo verniciato,
seduta e schienale in polipropilene

*Powder coated metal frame,
seat and backrest in polypropylene*

 KD
 77cm 41cm 43cm 44cm

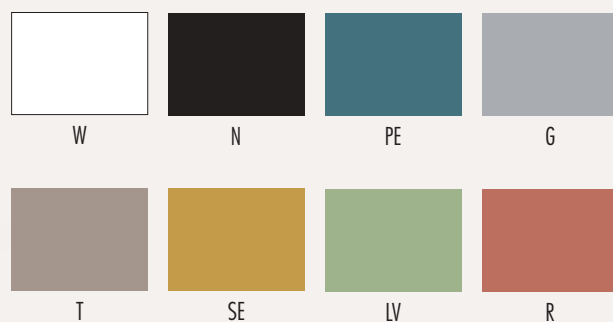





148 - RD012





 KD
 101cm 41cm 43cm 66cm

1903 - RD02





 KD
 111cm 41cm 43cm 76cm

Struttura in metallo verniciato, seduta e schienale in polipropilene
Powder coated metal frame, seat and backrest in polypropylene



T

SE

G

R

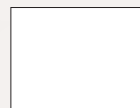

W



N



PE



LV





Struttura in polipropilene
Polypropylene frame

073 - ZL76

075 - ZL77





076 - ZL78



91cm 40cm 38cm 65cm

077 - ZL79



101cm 40cm 38cm 75cm

Struttura in polipropilene

Polypropylene frame



W N LG LV SE T R LB



Struttura in polipropilene
Polypropylene frame

451 - P82

452 - P82A





460 - P83



461 - P84



Struttura in polipropilene

Polypropylene frame





1842 - F28

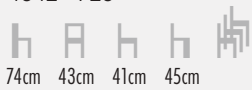

74cm 43cm 41cm 45cm

Struttura in polipropilene
Polypropylene frame





1841 - F80



103cm 37cm 36cm 76cm

Struttura in polipropilene
Polypropylene frame

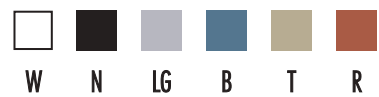





SEDIA CHAIR
441 - P79



POLTRONCINA ARMCHAIR
445 - P79A



SGABELLO BARCHAIR
446 - P80

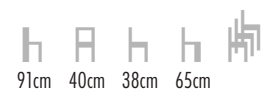

448 - P81



Struttura in polipropilene
Polypropylene frame



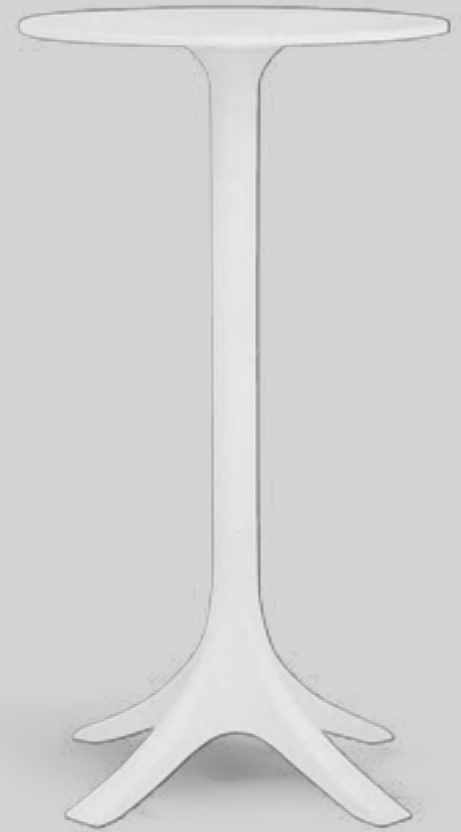

1734 - Y60
(Ø 60 x H111 cm) KD

☐ SEDIA CHAIR
1823 - 317A

☐ POLTRONCINA ARMCHAIR
1824 - 320A

Struttura e piano in polipropilene
Polypropylene frame and top



1735 - Y70
(Ø 70 x H74 cm) KD





071 - DH01
(Ø 70 x H74 cm) KD

Struttura e piano in polipropilene
Polypropylene frame and top



072 - DH02
(L70 x P70 x H74 cm) KD



1823 - 317A

Struttura in polipropilene con fibra di vetro

Polypropylene frame with fiberglass

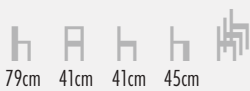

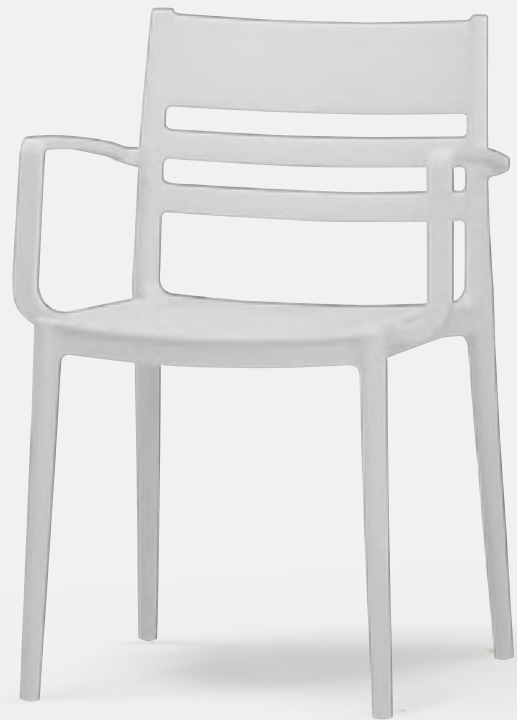





1824 - 320A

Struttura in polipropilene con fibra di vetro

Polypropylene frame with fiberglass

 79cm 41cm 41cm 45cm







 W N V M LG



462 - S03
Struttura in polipropilene
Polypropylene frame



81cm 44cm 38cm 45cm



W N R V LV B G T



463 - S03A

Struttura in polipropilene

Polypropylene frame





□ BASE TAVOLO *TABLE BASE*
1415 - TB712

□ PIANO *TOP*
290 - BST119



1501 - 9D

Struttura in polipropilene con fibra di vetro

Polipropylene frame with fiberglass

78,5cm 40cm 42cm 47cm

W N R SE T



BASE TAVOLO *TABLE BASE*
177 - TB718

PIANO *TOP*
291 - BST180 - COPPER PAINTED



1502 - 9E

Struttura in polipropilene con fibra di vetro
Polipropylene frame with fiberglass





 78,5cm 40cm 42cm 47cm







 W N R V G SE T



☐ SEDIA CHAIR
1054 - LIB
Struttura in polipropilene
Polypropylene frame







□ POLTRONCINA *ARMCHAIR*
1156 - WAM

Struttura in polipropilene
Polypropylene frame









449 - F18

Struttura in polipropilene

Polypropylene frame





by Ennio Mirrino

1893 - DH01

Struttura in polipropilene

Polypropylene frame

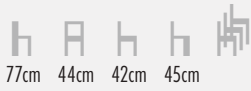

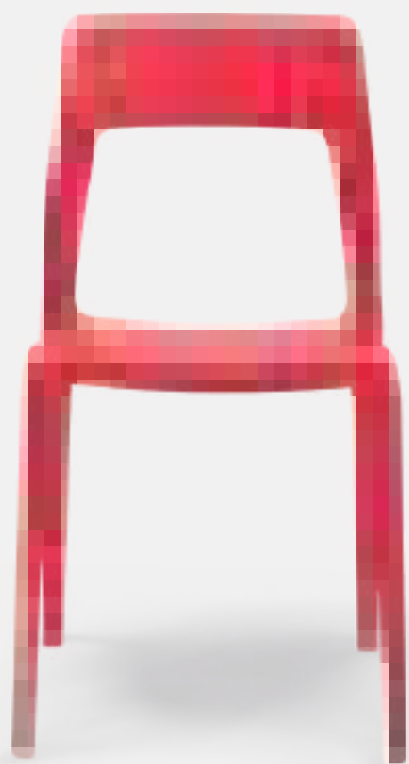

998 - SH15

Struttura in polipropilene

Polypropylene frame



85cm 42cm 40cm 46cm



W N R G T



1480 - XH3

Struttura in polipropilene

Polypropylene frame





 KD
 77,5cm 43,5cm 40cm 46cm



W N R V Y PE G T



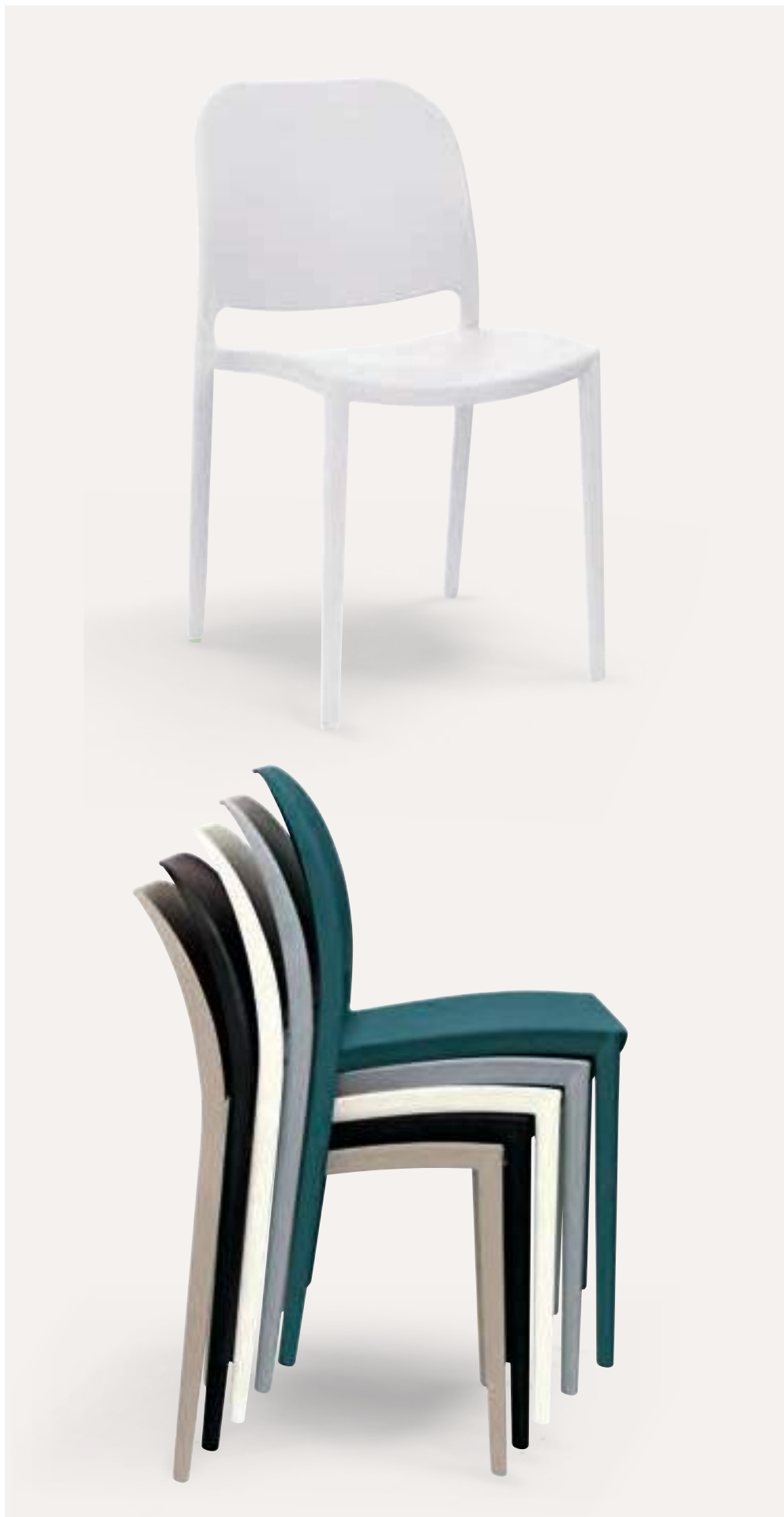

725 - Y19

Struttura in polipropilene
con fibra di vetro

*Polypropylene frame with
fiberglass*

h A h h 
79cm 46cm 45cm 46,5cm

    
W N G T P







1897 - DH04

Struttura e seduta in polipropilene,
seduta girevole

*Polypropylene frame and seat,
revolving seat*

83cm 30cm 30cm 76cm

W N





1483 - A11
Struttura in polipropilene
Polypropylene frame

h A h h h
88cm 45cm 42,5cm 46cm





□ TAVOLO TABLE
 984 - Z80 (Ø 80 cm x 110cm)
 Struttura in metallo verniciato,
 piano in polietilene
*Metal frame, powder coating
 polyethylene top*

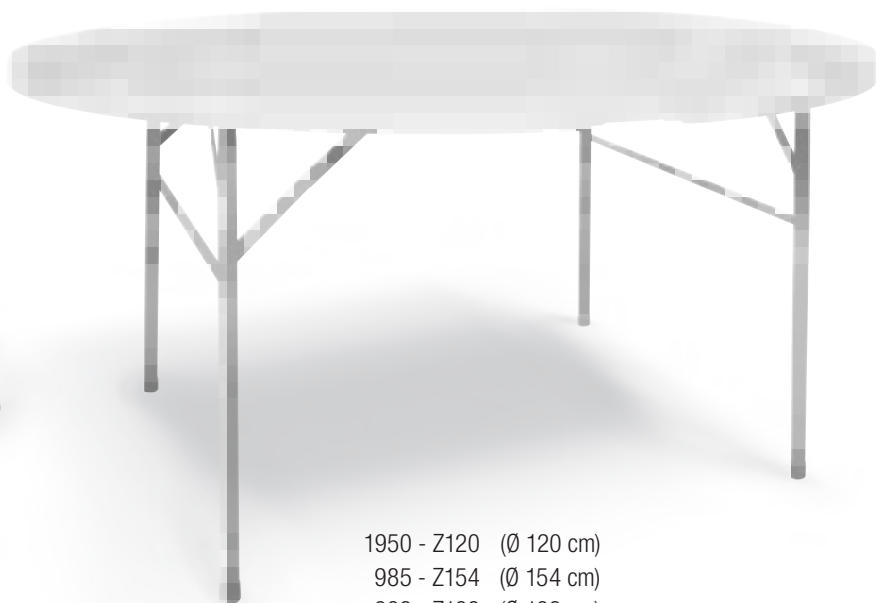

1950 - Z120 (Ø 120 cm)
 985 - Z154 (Ø 154 cm)
 983 - Z183 (Ø 183 cm)
 Struttura pieghevole in metallo verniciato,
 piano in polietilene pieghevole
*Folding metal frame,
 powder coating, folding polyethylene top*

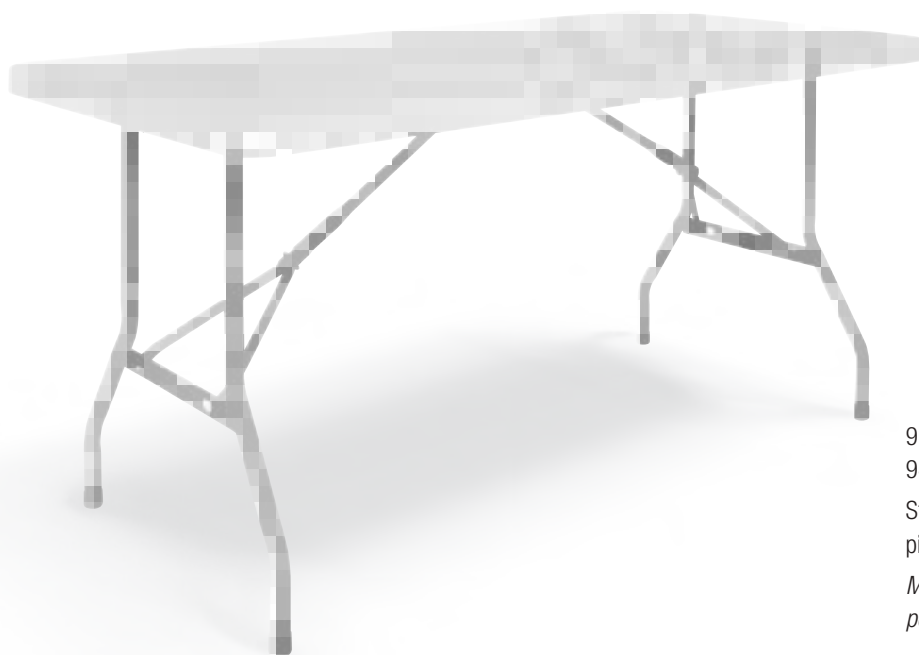

944 - Z152 (153 x 76 cm)
 945 - Z183C (183 x 76 cm)
 Struttura in metallo verniciato,
 piano in polietilene
*Metal frame, powder coating,
 polyethylene top*





1277 - M25

Struttura in polipropilene

Polypropylene frame

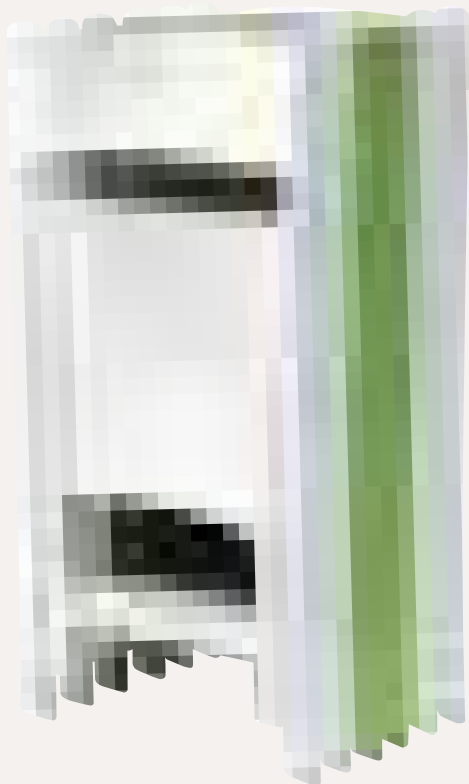

802 - Y012

Struttura in polipropilene
con fibra di vetro

*Polypropylene frame with
fiberglass*



819 - U13



 88cm 44cm 41,5cm 45cm

Struttura in polipropilene
Polypropylene frame

818 - U12



 97cm 44cm 41,5cm 45cm

W



N



M



J



Struttura in alluminio, rivestimento
in piattina di polietilene

*Aluminum frame, polyethylene
strap covering*



498 - L80801

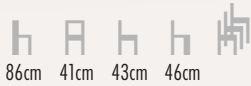

86cm 41cm 43cm 46cm



W

N

M



499 - L80804



87cm

47cm

45cm

44cm



560 - CTS0022
(L70 x P70 x H75 cm) KD

Struttura in alluminio, rivestimento in piattina di polietilene, piano in vetro temperato, base in alluminio

Aluminum frame, polyethylene strap covering, tempered glass top, aluminum base



W



N



M

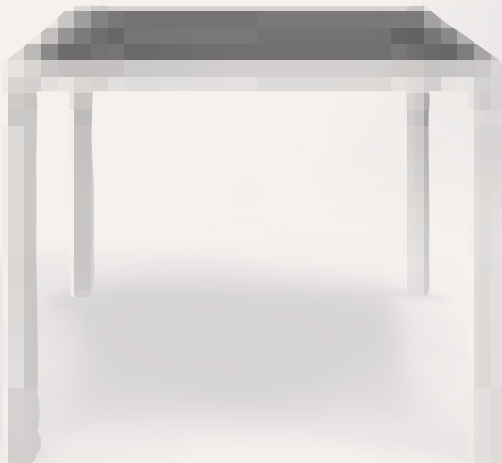

561 - MCQ 80 (L80 x P80 x H75 cm) KD
562 - MCQ 90 (L90 x P90 x H75 cm) KD
563 - MCQ 140 (L140 x P80 x H75 cm) KD

Struttura in alluminio, rivestimento in piattina di polietilene, piano in vetro temperato

Aluminum frame, polyethylene strap covering, tempered glass top



W



N

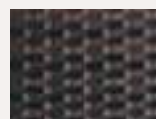

M



239 - S16

Struttura in polipropilene

Polypropylene frame

(L78 x P78 x H73 cm) KD



W

N

M



1044 - S15

Struttura in polipropilene

Polypropylene frame

(L77,5 x P77,5 x H73 cm) KD



W

N

M



566 - 0624T SET

- Tavolo + 4 sgabelli / Table + 4 bar stools
 Struttura in alluminio, rivestimento in piattina di polietilene, piano in vetro temperato
Aluminum frame, polyethylene strap covering, tempered glass top
 (L77 x P77 x H110 cm)



W



N



M



718 - MCR138

 91cm 41cm 41cm 46cm



719 - MCR139

 91cm 45cm 41cm 46cm

Struttura in alluminio verniciato, effetto bambù,
seduta e schienale in piattina di polietilene

*Aluminum frame, bamboo look,
polyethylene strap covering*



535 - AM12

88cm 39cm 42cm 44cm



536 - AM13

88cm 40cm 42cm 44cm

Struttura in alluminio verniciato,
tessuto in textilene

*Powder coated aluminum frame,
textilene covering*



062 - AM10



063 - AM09



Struttura in alluminio verniciato, effetto bambù,
rivestimento in piattina di nylon
*Aluminum frame, bamboo look,
nylon strap covering*





060 - AM03







 84cm 41cm 40cm 43,5cm



056 - AM02







 88cm 39cm 42cm 44,5cm



055 - AM01







 88cm 39cm 42cm 44,5cm

Struttura in alluminio verniciato, effetto bambù,
tessuto in textilene

*Aluminum frame, bamboo look,
textylene fabric covering*



038 - ALW05

h A h h 
72 cm 44cm 42cm 43cm

Struttura in alluminio anodizzato
Ø 25 x 1,5 mm, doghe in legno di rovere
*Anodized aluminum frame,
tube Ø 25 x 1,5 mm, oak bands*



040 - ALW07

h A h h 
77cm 42cm 41cm 43cm



043 - ALW12

h A h h 
95 cm 40cm 44cm 44,5cm

Struttura in alluminio anodizzato e saldato,
Ø 25 x 1,5 mm, doghe in legno di rovere
*Anodized aluminum welded frame,
tube Ø 25 x 1,5 mm, oak bands*

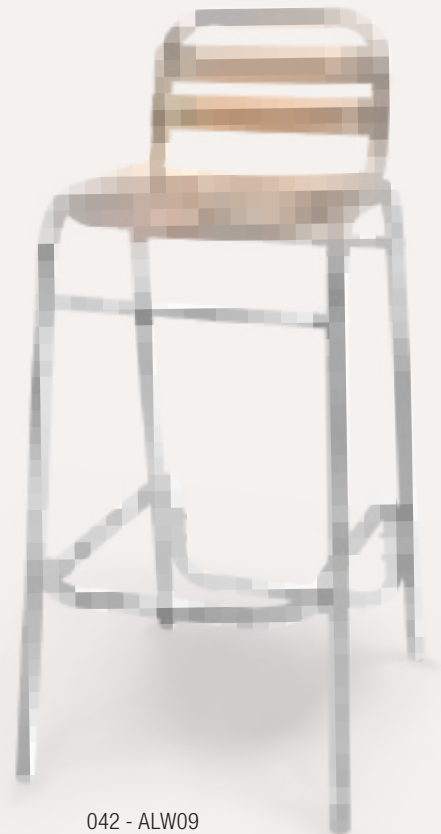

042 - ALW09

h A h h
100cm 40cm 35cm 80cm

Struttura in alluminio anodizzato
Ø 28 x 1,8 mm, doghe in legno di rovere
*Anodized aluminum frame,
tube Ø 28 x 1,8 mm, oak bands*



109 - MTW006A (60 x 60 cm)
 110 - MTW006B (70 x 70 cm)
 111 - MTW006C (80 x 80 cm)



106 - MTW001 (Ø 60 cm)
 107 - MTW007A (Ø 70 cm)
 108 - MTW007B (Ø 80 cm)



675 - MTW013A (60 x 60 cm)
 676 - MTW013B (70 x 70 cm)
 677 - MTW013C (80 x 80 cm)



678 - MTW011A (Ø 60 cm)
 679 - MTW011B (Ø 70 cm)



005 - ALL05



Struttura in alluminio anodizzato e saldato
 Ø 25 x 1,5 mm

*Anodized aluminum welded frame, tube
 Ø 25 x 1,5 mm*



007 - ALL07



454 - ALL33



Struttura in alluminio anodizzato e saldato
 Ø 25 x 1,5 mm

*Anodized aluminum welded frame,
 tube Ø 25 x 1,5 mm*



010 - ALL09



Struttura in alluminio anodizzato
 Ø 28 x 1,8 mm

*Anodized aluminum frame,
 tube Ø 28 x 1,8 mm*



☐ SEDIA *CHAIR*
713 - ALB07

Struttura saldata in alluminio verniciato
Powder coated welded aluminum frame



☐ POLTRONCINA *ARMCHAIR*
714 - ALB01

Struttura saldata in alluminio verniciato
Powder coated welded aluminum frame



☐ SGABELLO *BARSTOOL*
734 - ALLB02

Struttura in alluminio verniciato
Powder coated aluminum frame





097 - MTA013A (60 x 60 cm)
 098 - MTA013B (70 x 70 cm)
 099 - MTA013C (80 x 80 cm)



100 - MTA011A (Ø 60 cm)
 101 - MTA011B (Ø 70 cm)



093 - MTA007A (70 x 70 cm)
 094 - MTA007B (80 x 80 cm)



092 - MTA003A (Ø 70 cm)
 261 - MTA003B (Ø 80 cm)

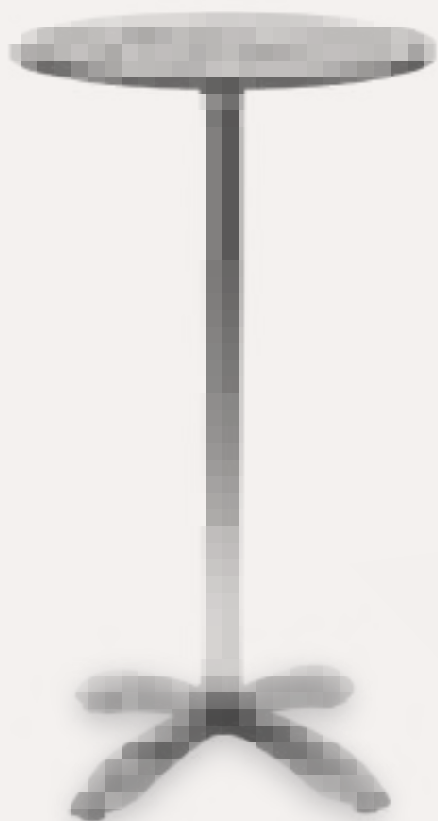

096 - MTA010 (Ø 60 cm)



095 - MTA009 (Ø 60 cm)



102 - MTA016K (Ø 60 cm)



089 - MTA002 (Ø 60 cm)



139 - M

Accessorio pieghevole per tutti i
tipi di tavoli con tubo centrale
*Folding system for all the tables
with central tube*



088 - MTA001 (Ø 60 cm)



Esterno

Outdoor



Interno

Indoor



1904 - RD03

Struttura in metallo verniciato,
seduta e schienale imbottiti, rivestimento in tessuto
*Powder coated metal frame,
padded seat and backrest, fabric covering*

 KD
 77cm 41cm 43cm 44cm

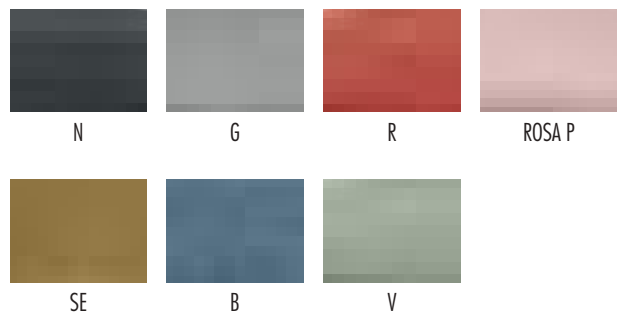





117 - RD011





 KD
 101cm 41cm 43cm 66cm



1905 - RD04



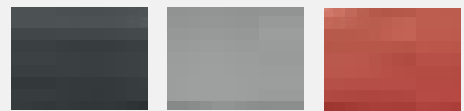

 KD
 111cm 41cm 43cm 76cm

Struttura in metallo verniciato,
 seduta e schienale imbottiti, rivestimento in tessuto
*Powder coated metal frame,
 padded seat and backrest, velvet covering*



N

G

R



ROSA P

SE

B

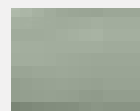

V





tessuto / fabric

ecopelle / synthetic leather



G

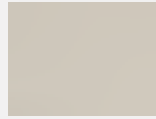

BE



LG



LM



h A h h
86cm 45cm 45cm 46cm

□ SEDIA CHAIR
469 - G1



□ SGABELLO BAR STOOL
471 - GA3

h A h h
102cm 40cm 40cm 76cm

Struttura in metallo, colore ottone satinato, seduta e schienale imbottiti, rivestimento in tessuto o ecopelle
Metal frame, brushed brass color, padded seat and backrest, fabric or synthetic leather covering



tessuto / fabric



G



ecopelle / synthetic leather



BE



LG



LM



h A h h
86cm 45cm 45cm 46cm

□ SEDIA CHAIR
470 - GA2



□ SGABELLO BAR STOOL
474 - GA4

h A h h
102cm 40cm 40cm 76cm

Struttura in metallo verniciato, seduta e schienale imbottiti, rivestimento in tessuto o ecopelle
Powder coated metal frame, padded seat and backrest, fabric or synthetic leather covering



1900 - DC01

Struttura in metallo,
seduta e schienale imbottiti
rivestimento in velluto

*Powder coated metal frame,
padded seat and backrest
velvet covering*

h A h h
89cm 45cm 43cm 46cm

velluto / velvet



LG

DG



R

B



V



1901 - DC02

Struttura in metallo,
seduta e schienale imbottiti
rivestimento in velluto

*Powder coated metal frame,
padded seat and backrest
velvet covering*

h A h h
86cm 46cm 46cm 46cm



467 - DC92B

Struttura in metallo verniciato, seduta e schienale imbottiti, rivestimento in ecopelle, piedini regolabili

Powder coated metal frame, padded seat and backrest, synthetic leather covering, adjustable feet

h A h h
78cm 44cm 43cm 45cm

ecopelle / synthetic leather



W



BE



LG



DG



468 - DC91

Struttura in metallo ottonato, seduta e schienale imbottiti,
rivestimento in velluto o ecopelle, piedini regolabili

*Metal frame gold effect, padded seat and backrest, velvet or
synthetic leather covering, adjustable feet*

velluto / velvet



LB



V



R



SE

h A h h
78cm 44cm 43cm 45cm



ecopelle / synthetic leather

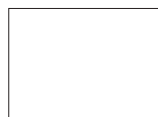

W



BE



LG



DG



LG

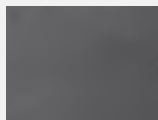

DG



LB



DB

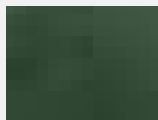

V



R



SE

1652 - J02

h A h h KD
79cm 44cm 42cm 46cm

Struttura in metallo ottonato, seduta e schienale imbottiti,
rivestimento in velluto

*Metal frame, gold effect, padded seat and backrest, velvet
covering*





LG

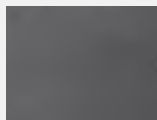

DG



LB



DB

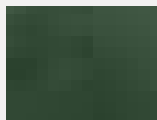

V



R



SE

1651 - J01G

h A h h KD
98cm 44cm 42cm 66cm

1764 - JA6G

h A h h KD
108cm 44cm 42cm 76cm

Struttura in metallo ottonato, seduta e schienale imbottiti,
rivestimento in velluto

*Metal frame, gold effect, padded seat and backrest, velvet
covering*





LG

DG

LB



DB

V



R

SE

1761 - JB1

 KD
 79cm 44cm 42cm 46cm

Struttura in metallo verniciato, seduta e schienale imbottiti, rivestimento in velluto

Powder coated metal frame, padded seat and backrest, velvet covering





1762 - JB4

h A h h KD
98cm 44cm 42cm 66cm



1763 - JA6

h A h h KD
108cm 44cm 42cm 76cm

Struttura in metallo verniciato, seduta e schienale imbottiti, rivestimento in velluto

Powder coated metal frame, padded seat and backrest, velvet covering



LG

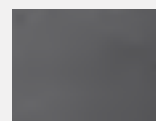

DG



LB



DB

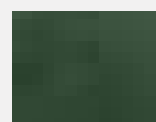

V



R



SE





1760 - S49

Struttura in metallo ottonato,
seduta e schienale imbottiti,
rivestimento in velluto

*Metal frame, gold effect,
padded seat and backrest,
velvet covering*

h A h h KD
77cm 110cm 43cm 46cm



1767 - S50

Struttura in metallo verniciato,
seduta e schienale imbottiti,
rivestimento in velluto

*Powder coated metal frame,
padded seat and backrest,
velvet covering*

h A h h KD
77cm 110cm 43cm 46cm



LG



DG



LB



DB



V



R



SE





1863 - FR02



 KD
 85cm 45cm 43cm 48cm

Struttura in metallo ottonato, seduta e schienale imbottiti, rivestimento in velluto
Metal frame, gold effect, padded seat and backrest, velvet covering

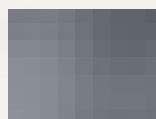
velluto / velvet

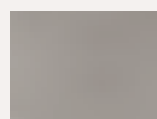

G



LG



LV



BO



B



Struttura in metallo ottonato,
seduta e schienale imbottiti,
rivestimento in velluto

*Metal frame, gold effect,
padded seat and backrest,
velvet covering*

velluto / velvet



G

LG

LV

B0

B

1867 - FR06

h A h h KD
90cm 45cm 43cm 64cm

080 - FR25

h A h h KD
103cm 45cm 43cm 75cm



1865 - FR04

h A h h  KD
85cm 45cm 43cm 48cm

Struttura in metallo verniciato, seduta e schienale imbottiti, rivestimento in velluto

Powder coated metal frame, padded seat and backrest, velvet covering



velluto / velvet



G

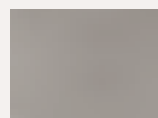

LG



LV



BO



B



Struttura in metallo verniciato,
seduta e schienale imbottiti,
rivestimento in velluto

*Powder coated metal frame,
padded seat and backrest,
velvet covering*

velluto / velvet



G

LG

LV

BO

B

1868 - FR07

h A h h KD
92cm 45cm 43cm 64cm

081 - FR26

h A h h KD
103cm 45cm 43cm 75cm



tessuto / fabric



LG



DG



DB

1938 - UK01

Struttura in metallo ottonato,
seduta e schienale imbottiti,
rivestimento in tessuto o velluto

*Metal frame, gold effect,
padded seat and backrest,
fabric or velvet covering*

h A h h KD
77cm 44cm 45cm 47cm

velluto / velvet



LG



DG



B



V



R



SE



1939 - UK02

Struttura in metallo verniciato, seduta e schienale imbottiti,
rivestimento in tessuto o velluto

*Powder coated metal frame, padded seat and backrest,
fabric or velvet covering*



h A h h KD
77cm 44cm 45cm 47cm

tessuto / fabric



LG



DG



DB

velluto / velvet



LG



DG



B



V



R



SE



□ POLTRONA *SOFA*
1616 - TOP9

h A h h KD
74cm 60cm 52cm 40cm

□ SEDIA *CHAIR*
1615 - TOP8

h A h h KD
85cm 48cm 46cm 47cm

□ SGABELLO *BARSTOOL*
087 - TOP21

h A h h KD
91cm 46cm 43cm 66cm

Struttura in metallo verniciato, seduta e schienale imbottiti,
rivestimento in tessuto o ecopelle
*Powder coated metal frame, padded seat and backrest,
fabric or synthetic leather covering*

1617 - TOP10

h A h h KD
101cm 46cm 43cm 76cm



tessuto / fabric



LG



DG



BE



LM





ecopelle / synthetic leather



W



N



DG

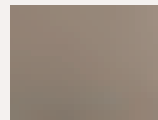

T





ecopelle / synthetic leather



W



N

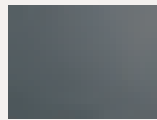

DG

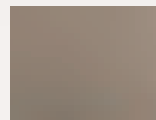

T





1954 - E14

Struttura in metallo verniciato, scocca imbottita,
rivestimento in ecopelle

*Powder coated metal frame, padded shell,
synthetic leather covering*





 KD
 89cm 42cm 46cm 46cm

ecopelle / synthetic leather

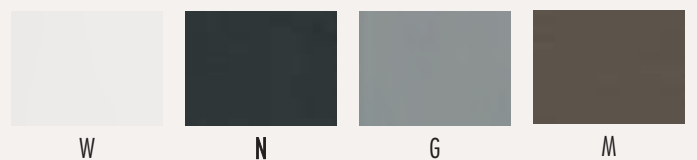



1954 - E14

Struttura in metallo verniciato, scocca imbottita,
rivestimento in tessuto

*Powder coated metal frame,
padded shell, fabric covering*

h A h h KD
89cm 42cm 46cm 46cm

tessuto / fabric



BE

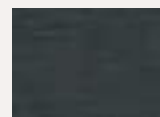

DG



G



539 - AV01

Struttura in metallo verniciato, seduta e schienale imbottiti,
rivestimento in velluto

*Powder coated metal frame, padded seat and backrest,
velvet covering*



81cm 44cm 44cm 47cm

velluto / velvet

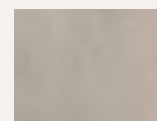

G

T

R



V

B



540 - AV012

Struttura in metallo verniciato, seduta e schienale
imbottiti, rivestimento in velluto

*Powder coated metal frame, padded seat and backrest,
velvet covering*



102cm 40cm 42cm 75cm

velluto / velvet



G

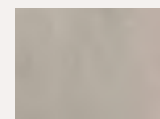

T



R



V



B



1528 - T07

Struttura in metallo verniciato,
seduta e schienale imbottiti,
rivestimento in ecopelle

*Powder coated metal frame,
padded seat and backrest,
synthetic leather covering*

h A h h KD
82cm 45cm 45cm 48cm

W N M G T

1693 - F450

Struttura in metallo verniciato,
seduta e schienale imbottiti,
rivestimento in velluto

*Powder coated metal frame,
padded seat and backrest,
velvet covering*

h A h h KD
81cm 43cm 46cm 46cm



M

T

VI

G

V

R



1438 - C50W

Struttura in metallo verniciato, gambe in legno di faggio,
seduta e schienale imbottiti, rivestimento in tessuto
*Powder coated metal frame, wood legs,
padded seat and backrest, fabric covering*

h A h h KD
81cm 44cm 44cm 48cm

tessuto / fabric



G



DB



tessuto / fabric



G

DB



ecopelle / synthetic leather



M

1439 - C50P

Struttura in metallo verniciato,
seduta e schienale imbottiti,
rivestimento in tessuto o ecopelle
*Powder coated metal frame,
padded seat and backrest,
fabric or synthetic leather covering*

h A h h KD
81cm 44cm 44cm 48cm



732 - MG01

Struttura in metallo verniciato,
seduta e schienale imbottiti, rivestimento in ecopelle
*Powder coated metal frame, padded seat
and backrest, synthetic leather covering*

h A h h KD
76cm 47cm 47cm 45cm

tessuto / fabric

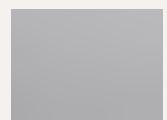

LG

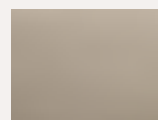

T



☐ POLTRONCINA *ARMCHAIR*
182 - XR3

h A h h KD
83cm 52cm 46cm 47cm

☐ SEDIA *CHAIR*
183 - XR4

h A h h KD
84cm 45cm 44cm 46cm

Struttura in metallo verniciato, scocca
imbottita, rivestimento in ecopelle
*Powder coated metal frame, padded shell,
synthetic leather covering*



M



G





1927 - TD03

Struttura in metallo verniciato,
scocca imbottita in ecopelle

*Powder coated metal frame,
padded shell,
synthetic leather covering*

h A h h KD
83cm 43cm 40cm 47cm

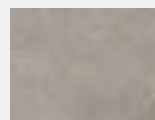

LG

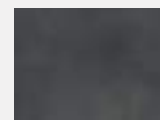

DG



BE



M



V



1928 - TD04

Struttura in metallo verniciato,
scocca imbottita in ecopelle

*Powder coated metal frame,
padded shell,
synthetic leather covering*

h A h h KD
108cm 40cm 35cm 76cm



LG



DG



BE



M



V



1803 - DC81

Struttura in metallo verniciato,
scocca imbottita in tessuto

*Powder coated metal frame,
padded shell in fabric covering*

h A h h KD
81cm 45cm 42cm 45cm



G



M



1802 - DC80

Struttura in metallo ottonato,
scocca imbottita in tessuto

*Metal frame, gold effect,
padded shell in fabric covering*

h A h h KD
81cm 45cm 42cm 45cm



1748 - XH9





 KD
 86cm 44cm 39cm 46cm



171 - XH11





 KD
 106cm 44cm 39cm 75cm

Struttura in metallo verniciato,
 scocca imbottita in ecopelle anticata
*Powder coated metal frame,
 padded shell in antique synthetic
 leather covering*



R



M

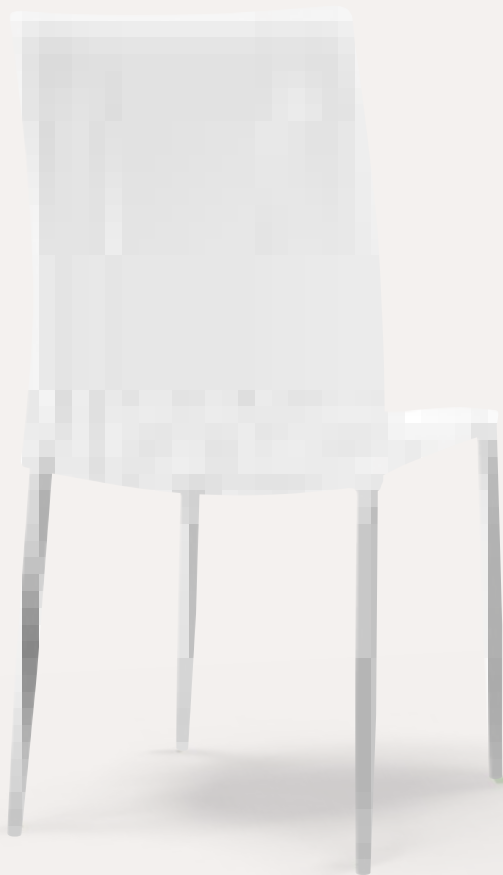

821 - RF49C

Struttura in metallo cromato,
seduta e schienale imbottiti,
rivestimento in ecopelle

*Chromed metal frame,
padded seat and backrest,
synthetic leather covering*



90cm 41,5cm 41,5cm 46cm



W N M

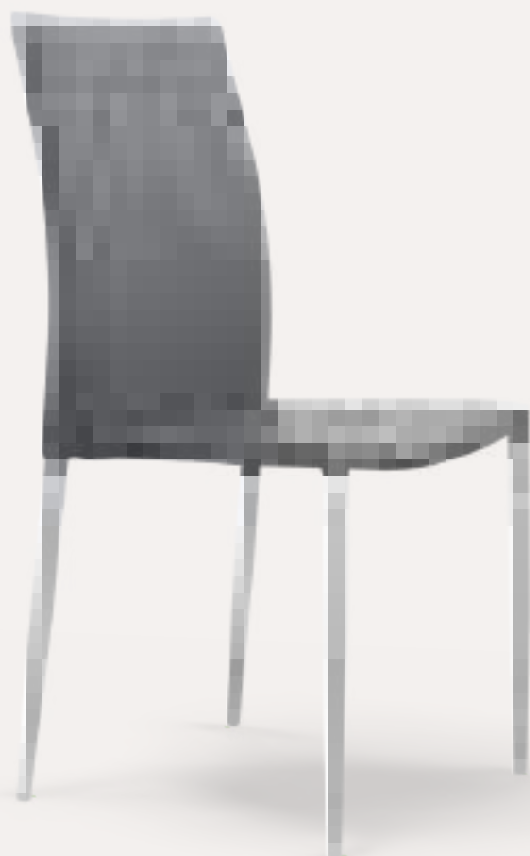

825 - RF49P

Struttura in metallo verniciato,
seduta e schienale imbottiti,
rivestimento in ecopelle

*Powder coated metal frame,
padded seat and backrest,
synthetic leather covering*



90cm 41,5cm 41,5cm 46cm



W N M G





949 - F400

Struttura in metallo,
seduta e schienale imbottiti,
rivestimento in ecopelle

*Metal frame, padded seat and backrest,
synthetic leather covering*

h A h h 
87cm 43cm 40cm 47,5cm





948 - F503

Struttura in metallo,
seduta e schienale imbottiti,
rivestimento in ecopelle

*Metal frame, padded seat and backrest,
synthetic leather covering*



96cm 43cm 40cm 47cm



W N R M G T



1451 - 7BD

Struttura in metallo, seduta e schienale imbottiti, rivestimento in ecopelle

Metal frame, padded seat and backrest, synthetic leather covering

87cm 42cm 41cm 47cm

1456 - 30D

Struttura in metallo, seduta e schienale imbottiti, rivestimento in ecopelle

Metal frame, padded seat and backrest, synthetic leather covering

95cm 42cm 42cm 46cm



1485 - F50

Struttura in metallo, seduta e schienale imbottiti,
rivestimento in ecopelle
*Metal frame, padded seat and backrest,
synthetic leather covering*



99cm 45cm 39cm 47cm



W N G M T



824 - RF97

Struttura in metallo, seduta e schienale imbottiti,
rivestimento in ecopelle

*Metal frame, padded seat and backrest,
synthetic leather covering*



96cm 45cm 45cm 46cm

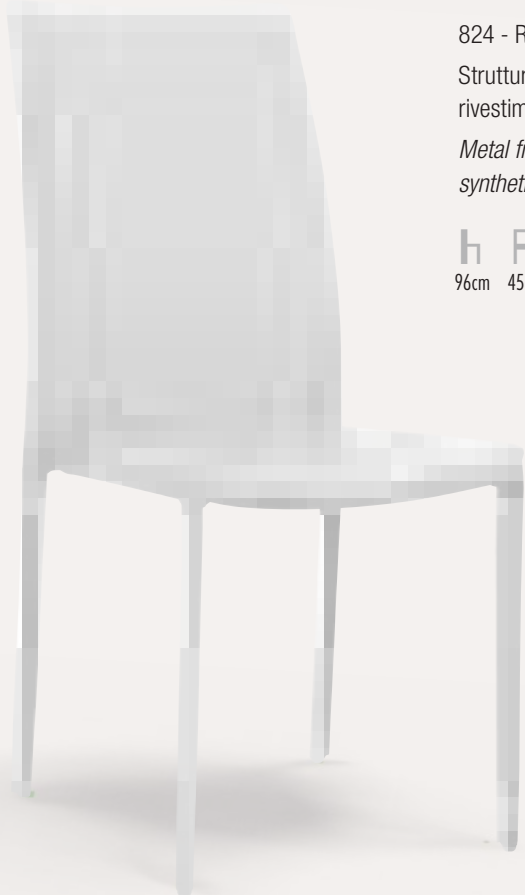

W N M G



118 - F601

h A h h
90cm 41cm 37cm 66cm



Struttura in metallo cromato, seduta e schienale imbottiti, rivestimento in ecopelle
Chromed metal frame, padded seat and backrest, synthetic leather covering



1007 - F600

h A h h
100cm 41cm 37cm 76cm



W N M G T





1524 - D22

h A h h KD
83cm 45cm 42cm 46cm



1523 - D23

h A h h KD
80cm 44cm 40cm 46cm

Struttura in legno di faggio e metallo verniciato,
scocca imbottita rivestimento in tessuto
*Powder coated metal and beech wood frame,
padded shell, fabric covering*



PK18



PK17



□ SEDIA CHAIR
542 - BX01

h 89cm
A 45cm
h 40cm
h 46cm

Struttura in legno di faggio e metallo verniciato, scocca imbottita, rivestimento in tessuto
Powder coated metal and beech wood frame, padded shell, fabric covering

□ POLTRONCINA ARMCHAIR
543 - BX02

h 80cm
A 42cm
h 40cm
h 45cm



1193 - PW72

Struttura in legno, scocca in polipropilene, seduta in ecopelle
Wood frame, polypropylene shell, synthetic leather pad





 KD
 81cm 48cm 43cm 46cm







 W N R A G V Y



1335 - W58

Struttura in metallo verniciato, gambe in legno,
scocca imbottita, rivestimento in ecopelle

*Powder coated metal frame,
wood legs, padded shell,
synthetic leather covering*

h A h h KD
85cm 57cm 51cm 47cm

ecopelle / synthetic leather







1335 - W58

Struttura in metallo verniciato,
gambe in legno, scocca imbottita
rivestimento in tessuto

*Powder coated metal frame,
wood legs, padded shell,
fabric covering*





 KD
 85cm 57cm 51cm 47cm



tessuto / fabric

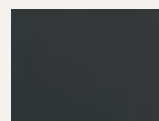

N



LR



LB



B



G



AZ

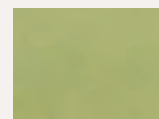

V



R



O





1586 - YG100

Struttura in legno multistrato di faggio,
scocca imbottita, rivestimento in tessuto

*Beech plywood frame, padded shell,
fabric covering*

h A h h KD
77cm 46cm 42cm 45cm



541 - YG103

Struttura in metallo verniciato,
scocca imbottita, rivestimento in ecopelle

*Powder coated metal frame, padded shell,
synthetic leather covering*

h A h h KD
77cm 46cm 42cm 45cm

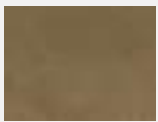

P23



P4

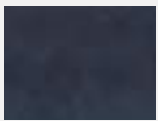

P5

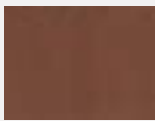

P12



P13



1587 - YG101

Struttura in legno
multistrato di faggio,
scocca imbottita,
rivestimento in ecopelle

*Beech plywood frame,
padded shell,
synthetic leather covering*

h A h h KD
77cm 46cm 42cm 44cm





1488 - YG93

Struttura in legno multistrato di faggio,
scocca in polipropilene, cuscino in ecopelle

*Beech plywood frame, polypropylene
shell, synthetic leather pad*

h A h h KD
76cm 42cm 42cm 44cm

□ ■ ■
W N LG



1626 - EV10

Struttura in legno di faggio e metallo,
seduta girevole, scocca in polipropilene,
cuscino in ecopelle

*Beech wood and metal frame,
swivel seat, polypropylene shell,
synthetic leather pad*





 KD
 84cm 46cm 41cm 46cm

scocca / shell



struttura / frame





465 - AP34

Struttura in legno di faggio e metallo verniciato, scocca in polipropilene
Powder coated metal and beech wood frame, polypropylene shell

h A h h
 43cm 44cm 42cm 45cm

W N LG SE



464 - V11

Struttura in legno di faggio, scocca in polipropilene

Beech wood frame, polypropylene shell

h A h h
79cm 44cm 40cm 44cm





W
 N
 G
 T
 V



1525 - D24

Struttura in metallo verniciato, gambe in legno di faggio,
scocca in polipropilene

Powder coated metal frame, beech wood legs, polypropylene shell





 KD
 75cm 41cm 42cm 45cm





 W N LG V B





1322 - Z87

Gambe in legno di faggio,
scocca in polipropilene

*Beech wood legs,
polypropylene shell*

h A h h KD
84cm 43cm 40cm 45cm







1846 - SI02

Struttura in legno verniciato,
seduta e schienale imbottiti,
rivestimento in ecopelle

*Painted wood frame,
padded seat and backrest,
synthetic leather covering*

 100cm 44cm 38cm 48cm

 W N DG LG M

1042 - C25F

Struttura in legno di faggio,
 seduta imbottita

*Beech wood frame,
 seat with pad*

 84cm 43cm 50cm 46cm



1041 - C25

Struttura in legno di faggio,
 seduta in legno multistrato

*Beech wood frame,
 plywood seat*

 84cm 43cm 50cm 46cm

 NA W R A V M





1847 - SI03

Struttura in legno di faggio

Beech wood frame





 110cm 38cm 38cm 79cm



1848 - SI04

Struttura in legno di faggio

Beech wood frame





 80cm 38cm 38cm 47cm







1037 - G03

Struttura in legno di faggio,
seduta impagliata

*Beech wood frame,
natural straw seat*

 87cm 40cm 37cm 47cm

 W R M G









1036 - G02

Struttura e seduta in legno di faggio

Frame and seat in beech wood





 87cm 42cm 39cm 46cm





W R M G





1258 - G04L
Struttura e seduta
in legno di faggio
*Frame and seat
in beech wood*

h A h h
102cm 40cm 37cm 73cm



W R M G



1038 - G04
Struttura in legno di faggio,
seduta impagliata
*Beech wood frame,
natural straw seat*

h A h h
102cm 40cm 37cm 73cm





- 240 - G07
(L70 x P70 x H76 cm)
- 1040 - G06
(L80 x P80 x H76 cm)
- 241 - G08
(L90 x P90 x H76 cm)
- 242 - G09
(L80/140 x P80 x H76 cm)
- 242 - G010
(L120/180 x P80 x H76 cm)

Struttura in legno di faggio, piano in laminato

*Beech wood frame,
laminated top*



- 244 - G011
(L70 x P70 x H76 cm)
- 1039 - G05
(L80 x P80 x H76 cm)
- 246 - G012
(L90 x P90 x H76 cm)
- 247 - G013
(L80/140 x P80 x H76 cm)
- 249 - G014
(L120/180 x P80 x H76 cm)







1188 - HT36

Struttura in legno, effetto anticato,
seduta in rattan

*Wood frame, antique look,
rattan seat*

h A h h
89cm 50cm 54cm 45cm



NA



ST

1321 - HT37

Struttura in legno, effetto anticato,
seduta in rattan

*Wood frame, antique look,
rattan seat*

h A h h
113cm 41cm 36,5cm 76cm





1188 - HT36

Struttura in legno, seduta in rattan

Wood frame, rattan seat

h A h h
89cm 50cm 54cm 45cm

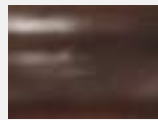

NO

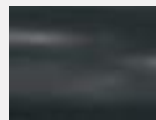

N

1321 - HT37

Struttura in legno, seduta in rattan

Wood frame, rattan seat

h A h h
113cm 41cm 36,5cm 76cm





1722 - SU22





 87cm 44cm 42cm 47cm

Struttura in legno effetto anticato, seduta in ecopelle o rattan
Wood frame antique look, synthetic leather or rattan seat



1721 - SU21





 87cm 44cm 42cm 47cm



RAT



SL



Struttura in legno, schienale in legno e metallo, seduta in ecopelle o rattan
Wood frame, wood and metal backrest, synthetic leather or rattan seat



1186 - HT35



89cm 50cm 54cm 45cm

Struttura in legno
Wood frame



W M



1440 - HT38



113cm 41cm 36,5cm 76cm



466 - TD90

Struttura in metallo verniciato,
seduta e schienale in legno multistrato

*Powder coated metal frame,
seat and backrest in plywood*

h A h h
83cm 44cm 42cm 47cm



legno / wood



1747 - XH2

Struttura in metallo verniciato, schienale in legno, seduta imbottita in ecopelle

Powder coated metal frame, plywood backrest, padded seat in synthetic leather covering



1777 - M18

Struttura in metallo verniciato, seduta e schienale imbottiti, rivestimento in ecopelle

Powder coated metal frame, padded seat and backrest in synthetic leather covering



1895 - DH02

Struttura in metallo verniciato, scocca in ABS

Powder coated metal frame, ABS shell







1785 - M58

Struttura in metallo verniciato, seduta in legno
Powder coated metal frame, wood seat

□ □
 33cm 74,5cm



1784 - MT14

Struttura in metallo verniciato, piano in legno d'olmo
Powder coated metal frame, elm wood top
 (Ø 60 x H105 cm)



1781 - M82

Struttura in metallo verniciato, seduta in legno
Powder coated metal frame, wood seat

h A h h
 86cm 36cm 36cm 45cm



1786 - MT15

(L80 x P80 x H75 cm)

1787 - MT16

(L120 x P60 x H75 cm) KD

Struttura in metallo verniciato, piano in legno d'olmo
Powder coated metal frame, elm wood top



1779 - M51

Struttura in metallo verniciato, seduta regolabile in legno
Powder coated metal frame, adjustable wood seat

□ □
 33cm 66/86cm



1778 - M50

Struttura in metallo verniciato, schienale e seduta regolabile in legno
Powder coated metal frame, adjustable wood seat and backrest

h A h h
 96/113cm 32cm 32cm 66/83cm



1780 - M52

Struttura in metallo verniciato, seduta regolabile in legno
Powder coated metal frame, adjustable wood seat

□ □
 33cm 40/57cm



1417 - BM37

Struttura in metallo verniciato,
effetto anticato, seduta regolabile in legno

*Powder coated metal frame,
antique look, adjustable wood seat*

□ □ KD
33cm 65/78cm



1800 - MT48

Struttura in metallo verniciato,
piano in legno

*Powder coated metal frame,
wood top*

(Ø 42 x H40 cm)



1914 - CD02

Struttura in metallo verniciato,
seduta regolabile in legno e sughero

Powder coated metal frame, adjustable seat in wood and cork

33cm 69/89cm



1915 - CD03

Struttura in metallo verniciato,
seduta regolabile in legno e sughero

Powder coated metal frame, adjustable seat in wood and cork

33cm 43/60cm



1916 - CD04

Struttura in metallo verniciato,
seduta in legno e sughero

Powder coated metal frame, seat in wood and cork

33cm 77cm



1913 - CD01

Sgabello in sughero
Cork stool

26cm 46cm



1977 - CD05

Struttura in metallo verniciato,
seduta in sughero

*Powder coated metal frame,
cork seat*

□ □ KD
29cm 58/79cm

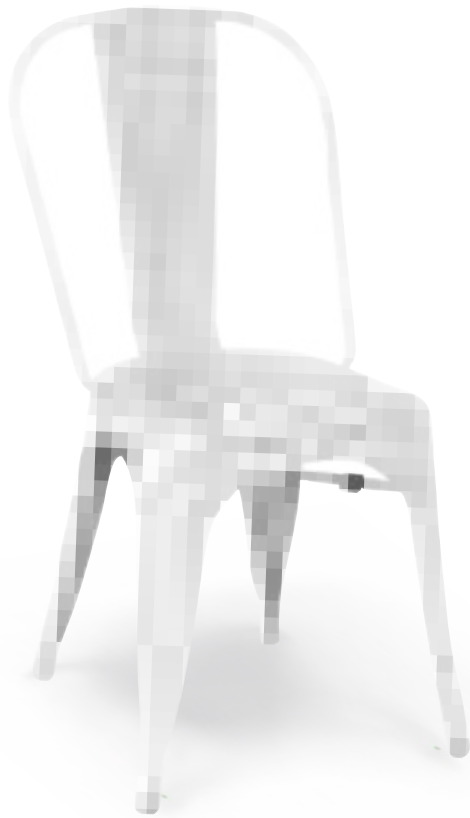

976 - ET53

Struttura in metallo verniciato

Powder coated metal frame

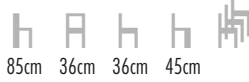

85cm 36cm 36cm 45cm



W N R





SEDIA CHAIR

978 - EM53W

Struttura in metallo verniciato, seduta in legno

Powder coated metal frame, wood seat



85cm 36cm 36cm 45cm



W

N

TAVOLO TABLE

1265 - 70W

(L70 x P70 x H74 cm) KD

972 - 36W

(L80 x P80 x H74 cm) KD

1418 - CT120

(L120 x P80 x H74 cm) KD

Struttura in metallo verniciato / *Powder coated metal frame*





1084 - BT18

Struttura in metallo verniciato

Powder coated metal frame





955 - MC012

h A h h KD
98,5cm 30cm 30cm 76cm



1083 - MC012W

h A h h KD
98,5cm 30cm 30cm 76cm



977 - BT503

h h h
30cm 30cm 76cm



1082 - BT503W

h h h
30cm 30cm 76cm

Struttura in metallo verniciato / Powder coated metal frame

Struttura in metallo verniciato, seduta in legno
Powder coated metal frame, wood seat



1266 - CT60

Struttura in metallo verniciato

Powder coated metal frame

(L60 x P60 x H105 cm) KD



W N



1427 - 01N



85cm 36cm 36cm 45cm



1496 - BT04



30cm 30cm 76cm

Struttura in metallo verniciato, effetto canna di fucile
Powder coated metal frame, gun look



1832 - BS18

Struttura in metallo verniciato, effetto anticato

Powder coated metal frame, antique look

□ □ □
30cm 30cm 46cm



1295 - BT03

Struttura in metallo verniciato,
effetto anticato

*Powder coated metal frame,
antique look*



30cm 30cm 76cm



W N R Y







1100 - M51

Struttura in metallo verniciato, effetto anticato
Powder coated metal frame, antique look





 85cm 36cm 36cm 45cm





 W N R Y



1575 - 36WA

Struttura in metallo verniciato,
effetto anticato

*Powder coated metal frame,
antique look*

(L80 x P80 x H75 cm) KD





□ SEDIA CHAIR
968 - MC001D



□ TAVOLO TABLE
956 - 36D
(L82 x P82 x H76 cm) KD

Struttura in metallo verniciato, effetto anticato
Metal frame, brush painting, antique look

1077 - MC001DW
Struttura in metallo verniciato,
effetto anticato, seduta in legno
*Metal frame, brush painting,
antique look, wood seat*





1061 - MC012D

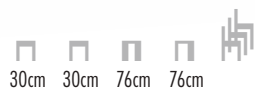

1062 - MC012DT



1263 - 009T

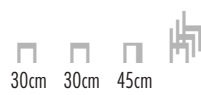

Struttura in metallo verniciato effetto anticato
Metal frame, brush painting, antique look



1079 - MC012DTW

Struttura in metallo verniciato effetto anticato, seduta in legno
Metal frame, brush painting, antique look, wood seat

h A h h KD
 98cm 30cm 30cm 76cm



1268 - GT28

Struttura in metallo verniciato
 effetto anticato

*Metal frame, brush painting,
 antique look*

(L65 x P65 x H107 cm) KD



1078 - MC012DW

Struttura in metallo verniciato
 effetto anticato, seduta in legno

*Metal frame, brush painting,
 antique look, wood seat*

h h h h
 30cm 30cm 76cm



□ SEDIA CHAIR
969 - MC001T



85cm 36cm 36cm 45cm

□ TAVOLO TABLE
1262 - 236D
(L80 x P80 x H76 cm) KD

Struttura in metallo verniciato
con vernice trasparente

Powder coated metal frame with varnish

1066 - MC001TW

Struttura in metallo verniciato
con vernice trasparente, seduta in legno

*Powder coated metal frame,
with varnish, wood seat*



85cm 36cm 36cm 45cm





966 - MC012T



30cm 30cm 76cm



1060 - MC012PT



98cm 30cm 30cm 76cm KD



1264 - 010T

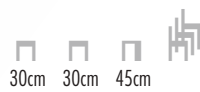

30cm 30cm 45cm

Struttura in metallo verniciato con vernice trasparente
Powder coated metal frame with varnish



1068 - MC012PTW

Struttura in metallo verniciato con vernice trasparente, seduta in legno

Powder coated metal frame with varnish, wood seat





 KD
 98cm 30cm 30cm 76cm



1267 - GT24

Struttura in metallo verniciato con vernice trasparente

Powder coated metal frame with varnish

(L65 x P65 x H107 cm) KD



1067 - MC012TW

Struttura in metallo verniciato con vernice trasparente, seduta in legno

Powder coated metal frame with varnish, wood seat

 30cm 30cm 76cm



□ SEDIA CHAIR
1673 - PA1

Struttura in legno
Rubber wood frame

h A h h
89cm 44cm 43cm 44cm

legno / wood

NO N/M



1674 - PA2

Struttura in legno
Rubber wood frame

h A h h
89cm 44cm 43cm 44cm

legno / wood

NO N/M



TAVOLO *TABLE*
715 - SN02

Struttura pieghevole in legno di faggio
Beech wood, folding frame
(L60 x P80 x H73,5 cm)

SEDIA *CHAIR*
1912 - SN01

Struttura pieghevole in legno di faggio
Beech wood, folding frame

76cm 37,5cm 35cm 45cm

W N G LG R M V NA



545 - DC96

h A h h KD
94cm 39cm 38cm 65cm

546 - DC97

h A h h KD
99cm 39cm 38cm 75cm



544 - DC95

h A h h KD
77cm 47cm 43cm 44cm

Struttura in metallo verniciato, seduta e schienale in legno multistrato

Powder coated metal frame, plywood seat and backrest

I T O®
ITALIAN ORIGINAL



083 - AR100

Struttura in metallo verniciato,
seduta in polipropilene

*Powder coated metal frame,
polypropylene seat*

h A h h
88cm 40cm 46cm 46cm

084 - AR38

Struttura in metallo verniciato,
seduta in polipropilene

*Powder coated metal frame,
polypropylene seat*

h A h h h
87cm 40cm 46cm 46cm





1589 - YG103

Struttura in metallo cromato, scocca in polipropilene,
cuscino in ecopelle

*Chromed metal frame, polypropylene shell,
synthetic leather pad*

h A h h KD
76cm 42cm 42cm 45cm

□ ■ ▒
W N G



1486 - YG91

Struttura in metallo cromato, scocca in polipropilene,
cuscino in ecopelle

*Chromed metal frame, polypropylene shell,
synthetic leather pad*

h A h h KD
77cm 42cm 42cm 45cm

□ ■ ▒
W N G



074 - CT123

Struttura in metallo cromato,
scocca in polipropilene

*Chromed metal frame,
polypropylene shell*



82cm 39cm 42,5cm 46cm



W

N



587 - AM01

Struttura pieghevole in metallo
verniciato, seduta e schienale in
polipropilene

*Powder coated metal foudable
frame, polypropylene seat and
backrest*



76cm 38cm 38cm 47cm



W

N

ITD[®]
ITALIAN ORIGINAL





1149 - 076

Struttura in metallo cromato,
scocca in polipropilene, cuscino in ecopelle

*Chromed metal frame,
polypropylene shell, synthetic leather pad*

h A h h KD
82cm 48cm 50cm 45cm

W R N G



889 - PC492

Struttura in policarbonato

Polycarbonate frame

h A h h 

85cm 37cm 38,5cm 48cm



591 - BX10

Struttura in metallo cromato,
seduta in policarbonato,
cuscino in ecopelle

*Chroed metal frame,
polycarbonate seat,
synthetic leather pad*

h A h h KD

84cm 37cm 39cm 75cm



1259 - M0120C

Struttura in policarbonato

Polycarbonate frame



95cm 41cm 45cm 46cm



T W N





1497 - K31

Struttura in legno e metallo verniciato,
seduta in polipropilene, cuscino in ecopelle

*Powder coated metal and wood frame,
polypropylene shell, synthetic leather pad*





 KD
 99cm 39cm 33cm 76cm



 W N G



1500 - K32

Struttura in legno,
seduta in polipropilene,
cuscino in ecopelle

*Wood frame,
polypropylene seat,
synthetic leather pad*

h A h h KD
85cm 40cm 40cm 76cm

□ ■ ▒
W N G





1627 - EV36

Struttura in legno di quercia,
scocca in polipropilene

Oak wood frame, polypropylene shell

h A h h KD
102cm 39cm 34cm 77cm



1639 - EV37

Struttura in legno di quercia,
scocca in polipropilene, seduta in ecopelle

*Oak wood frame, polypropylene shell,
synthetic leather pad*

h A h h KD
110cm 46cm 41cm 74cm





599 - DP3





 KD
 112cm 44cm 40cm 76cm

Struttura in legno di faggio e metallo verniciato, scocca in polipropilene
Powder coated metal and beech wood frame, polypropylene shell



□ TAVOLO *BAR TABLE*
594 - CW1

Struttura in metallo verniciato, piano in MDF
Powder coated metal frame, MDF top
(Ø60 x H110 cm) KD

□ SGABELLO *BAR STOOL*
597 - CC1

Struttura in metallo verniciato, seduta in polipropilene con cuscino in ecopelle
Powder coated metal frame, polypropylene seat, synthetic leather pad

h A h h
85cm 43cm 43cm 75cm



932 - K38

Struttura in metallo cromato,
scocca in polipropilene

*Chromed metal frame,
polypropylene shell*

KD
 100cm 39cm 34cm 77cm





1630 - EV23

Struttura in metallo cromato, seduta in polipropilene, cuscino in ecopelle

Chromed metal frame, polypropylene seat, synthetic leather pad

h A h h KD
87cm 39cm 39cm 77cm



□ ■ ■ ■
W N R G



933 - K08

Struttura in metallo cromato,
scocca in polipropilene

*Chromed metal frame,
polypropylene shell*

h A h h KD
104/83cm 39cm 34cm 81/60cm

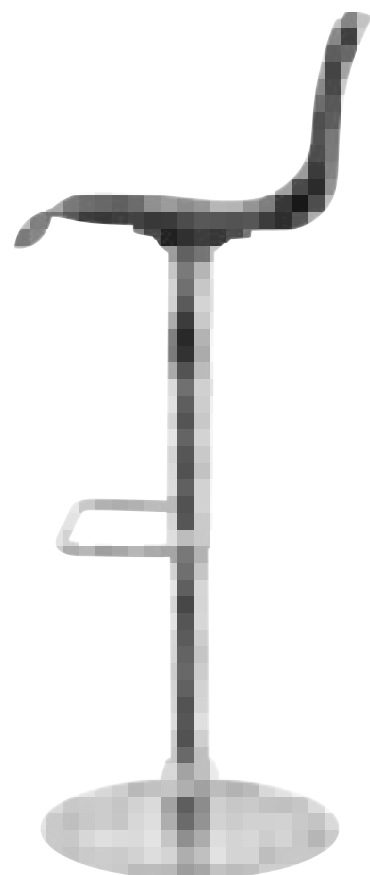
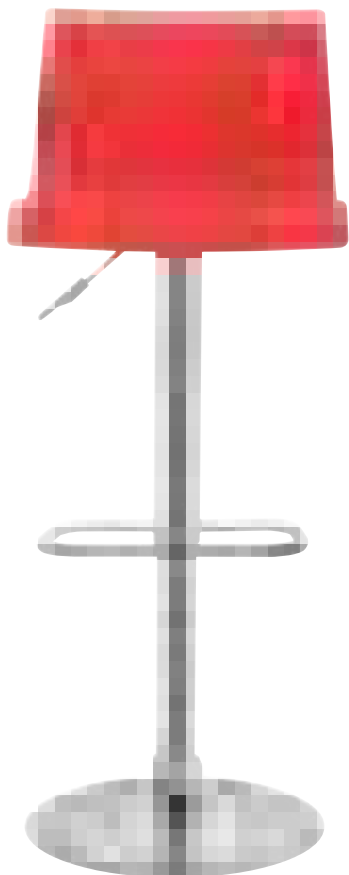



997 - K3001

Struttura in metallo cromato,
scocca in polipropilene,
cuscino in ecopelle

*Chromed metal frame,
polypropylene shell,
synthetic leather pad*

h A h h KD
107/86cm 41cm 37cm 81/60cm



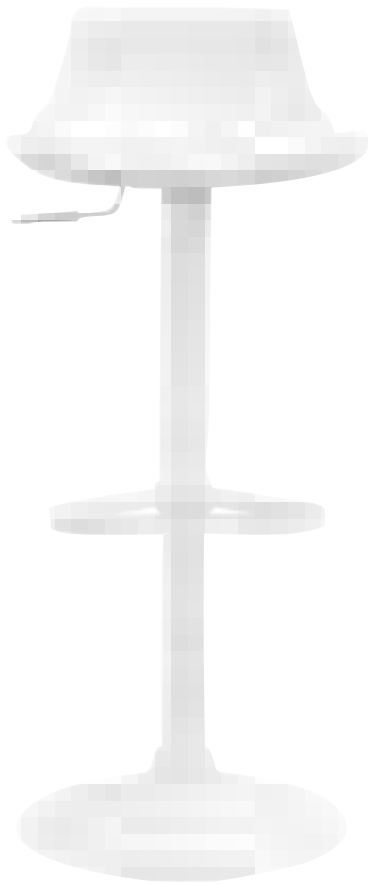

1031 - 795

Struttura in metallo verniciato,
scocca in polipropilene

*Powder coated metal frame,
polypropylene shell*

h A h h KD
94/73 cm 39cm 34cm 78/57cm



Struttura in metallo cromato, seduta e schienale in ecopelle
Chromed metal frame, seat and backrest in synthetic leather



1113 - BY035

h A h h KD
108/86cm 37cm 32cm 80/58cm





602 - XH2

Struttura in metallo verniciato,
seduta imbottita rivestita in ecopelle

*Powder coated metal frame,
padded seat, synthetic leather
covering*

h A h h KD
88/68 cm 40cm 36cm 77/57cm



DG

DM

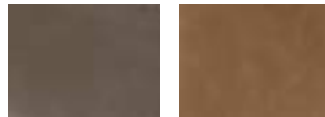

LM

M



604 - XH9

Struttura in metallo verniciato,
seduta imbottita rivestita in ecopelle

*Powder coated metal frame,
padded shell, synthetic leather
covering*

h A h h KD
108/88cm 38cm 35cm 78/58cm



□ TAVOLO TABLE
224 - TB009

Struttura in acciaio cromato,
piedini regolabili, piano in poliestere
*Chromed steel frame,
polyester top*
(Ø 76 cm, H 106 cm)



245 - B030

Struttura in metallo cromato, seduta girevole in ecopelle
Chromed metal frame, swivel seat, synthetic leather seat and backrest

h h h KD
107,5cm 38cm 76cm





593 - C2842

Struttura in metallo cromato,
seduta e schienale in ecopelle

*Chromed metal frame,
synthetic leather seat and back*

h A h h KD
85cm 45cm 53cm 46cm

■ ■ ■
N R V



605 - ZWH1

609 - ZW2

 KD
 108/102cm 51cm 45cm 51/45cm

Struttura in metallo cromato, seduta imbottita, rivestita in ecopelle
 Chromed metal frame, padded seat, synthetic leather covering

 KD
 93/87cm 51cm 45cm 51/45cm



629 - ZW5

Struttura in metallo cromato, seduta imbottita,
rivestita in ecopelle

*Chromed metal frame, padded seat,
synthetic leather covering*





 KD
 87,5cm 51cm 45cm 47cm



W

N



610 - ZWH3

 108/102cm 51cm 45cm 51/45cm KD

Struttura in metallo cromato, seduta imbottita,
 rivestita in ecopelle, schienale in textilene
*Chromed metal frame, padded seat, synthetic
 leather covering, textylene backrest*

612 - ZW4

 93/87cm 51cm 45cm 51/45cm KD



605 - ZWH1





609 - ZW2





 KD
 108/102cm 51cm 45cm 51/45cm

Struttura in metallo cromato, seduta imbottita, rivestita in ecopelle
 Chromed metal frame, padded seat, synthetic leather covering





 KD
 93/87cm 51cm 45cm 51/45cm



1237 - HM2

h A h h KD
111/105cm 50cm 43cm 50/44cm

1238 - MM2

h A h h KD
95/89cm 58cm 59cm 50/44cm

1239 - VM2

h A h h KD
94cm 57cm 56cm 46cm



Struttura in alluminio e acciaio cromato, rivestimento in textilene / Aluminum and chromed iron frame, textilene covering



1234 - HL1

h A h h KD
111/105cm 50cm 43cm 50/44cm

1235 - ML1

h A h h KD
95/89cm 50cm 43cm 50/44cm

1236 - VL1

h A h h KD
94cm 50cm 43cm 46cm



Struttura in alluminio e acciaio cromato, rivestimento in ecopelle / Aluminum and chromed iron frame, synthetic leather covering



529 - W81

Struttura in nylon con fibra di vetro,
base in alluminio cromata, seduta in tessuto,
schienale in textilene,
6 possibilità di regolazione

*Nylon frame with fiberglass,
chromed aluminum base,
fabric seat, textylene backrest,
6 positions of adjustment*



98,5/90cm 51,5cm 50cm 51,5/43cm



W N R B



671 - W03

Base cromata, rivestimento in
textilene ed ecopelle

*Chromed metal base, synthetic
leather and mesh fabric
upholstery*

h A h h
115/107cm 61cm 63cm 52/45cm



606 - W94

Struttura in nylon con fibra di vetro,
base cromata, seduta in tessuto,
schienale in textilene,
8 possibilità di regolazione

*Nylon frame with fiberglass, chromed base,
fabric seat, textylene backrest,
8 positions of adjustment*

h A h h
122/113cm 51,5cm 50cm 52/43cm



666 - CW13

Struttura in metallo verniciato,
piano e cassetto in MDF
impiallacciato

*Powder coated metal frame,
veneered MDF
top and drawer*

(L118 x P60 x H77 cm)



1628 - EV11

Struttura in metallo verniciato,
scocca in polipropilene

*Powder coated metal frame,
polypropylene shell*





 KD
 86/93cm 44cm 37cm 47/54cm



 W N





1491 - YG98

Struttura in metallo cromato,
scocca in polipropilene, cuscino in ecopelle

*Chromed metal frame,
polypropylene shell, synthetic leather pad*

h A h h KD
81/76cm 42cm 42cm 50/45cm

scocca / shell





669 - WX910

Struttura in metallo cromato,
seduta e schienale in ecopelle

*Chromed metal frame,
synthetic leather seat and backrest*

h A h h KD
92/84cm 49cm 57cm 50/42cm





1126 - K03

Struttura in metallo cromato, scocca in polipropilene, cuscino in ecopelle
 Chromed metal frame, polypropylene shell, synthetic leather pad

h A h h KD
 90/78cm 39cm 43cm 54/42cm

W N R Y G V



620 - X17PS

Struttura in acciaio inox,
rivestimento in ecopelle

*Stainless steel frame,
synthetic leather covering*

(L76 x P70 x H68 cm)



W

N



619 - X17D2S

Struttura in acciaio inox, rivestimento in ecopelle

Stainless steel frame, synthetic leather covering

(L130 x P70 x H68 cm)



W N





1653 - B01T

Struttura in metallo cromato, piano in vetro temperato
Chromed metal frame, tempered glass top
 (L60 x P60 x H45 cm)



618 - X17D3S

Struttura in acciaio inox, rivestimento in ecopelle
Stainless steel frame, synthetic leather covering
 (L180 x P70 x H68 cm)



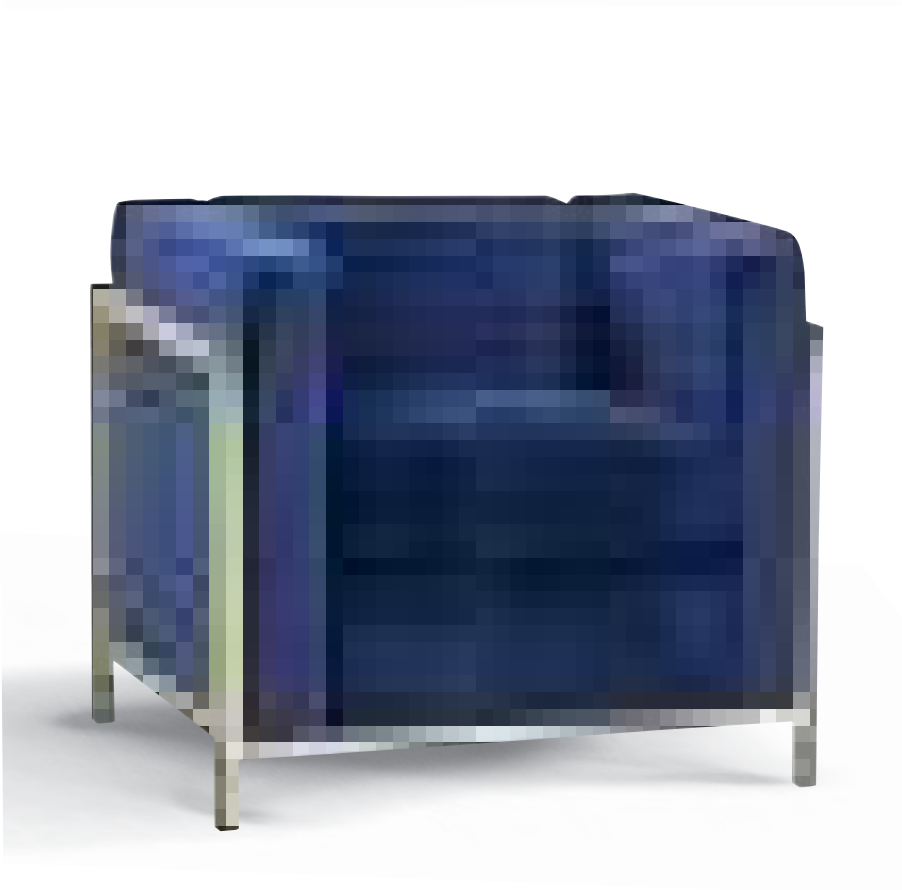

1797 - HKP2

Struttura in metallo ottonato, rivestimento in velluto

Metal frame, gold effect, velvet covering

(L76 x P67 x H71 cm)

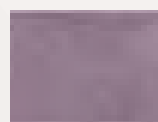

VI



B



I T O
ITALIAN DESIGN



1604 - 06S

Struttura in metallo verniciato,
rivestimento in tessuto

*Powder coated metal frame,
fabric covering*

(L123 x P50 x H77 cm)



G

B

A

Y

LR

V

I T O
ITALIAN DESIGN



1605 - 06P

Struttura in metallo verniciato,
rivestimento in tessuto

*Powder coated metal frame,
fabric covering*

(L64 x P50 x H77 cm)



G

B

A

Y

LR

V



1603 - 06T

Struttura in metallo verniciato,
rivestimento in tessuto

*Powder coated metal frame,
fabric covering*

(L63 x P47 x H37 cm)



G



B



A



Y



LR



V

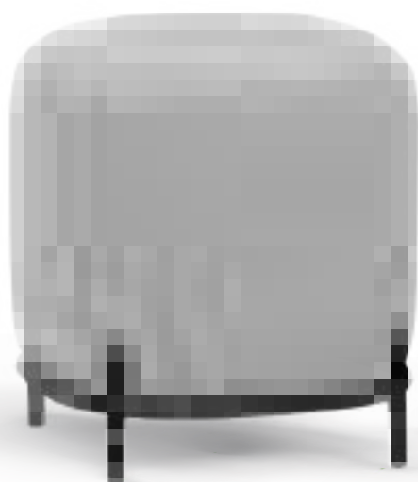

1774 - S03

Struttura in metallo verniciato,
rivestimento in tessuto

*Powder coated metal frame,
fabric covering*

 42cm
  42cm
  45cm



G



B



A



Y



LR



V





733 - DA3

Base in metallo cromato,
scocca imbottita
rivestita in tessuto

*Chromed metal base,
padded shell, fabric covering*
(L60 x P47 x H102 cm)



050 - DA2

Base in metallo verniciato,
scocca imbottita
rivestita in tessuto

*Powder coated metal base,
padded shell, fabric covering*
(L60 x P47 x H102 cm)



G



LB



N



V



GM



DB



1520 - S8V

Struttura in metallo verniciato, rivestimento in tessuto o in ecopelle

Powder coated metal frame, fabric or synthetic leather covering

(L59 x P53 x H76 cm)



tessuto / fabric



N



LG



B



V



1678 - SE10

Struttura in metallo verniciato, piano in MDF verniciato

Powder coated metal frame painted, MDF top

(L74,5 x P49,5 x H42,5 cm)

piano / top



1681 - SE02

(L92 x P50 x H40,5 cm)

672 - SE04

(L130 x P57 x H40,5 cm)

Struttura in metallo verniciato, piano MDF verniciato

Powder coated metal frame painted, MDF top

piano / top







682 - WD3
(L60 x P60 x H33 cm)



Struttura in metallo verniciato, piano in laminato
Powder coated metal frame painted, laminated top





673 - WD1
(L140 x P80 x H40 cm)



674 - WD2
(L50 x P50 x H50 cm)

Struttura in metallo verniciato, piano in MDF impiallacciato
Powder coated metal frame painted, veneered MDF top



1611 - TOP4

Struttura in metallo verniciato, piano in MDF impiallacciato noce
Powder coated metal frame, walnut veneered MDF top
(L80 x P80 x H47 cm)



1619 - TOP12

Struttura in metallo verniciato, piano in MDF impiallacciato noce
Powder coated metal frame, walnut veneered MDF top
(L120 x P60 x H35 cm)



1713 - DK70

Struttura in legno,
rivestimento in tessuto

*Wood frame,
fabric covering*

h A h h KD
86cm 53cm 46cm 47cm



BE



M



PE



N



A



V





1712 - DK65

Struttura in legno, rivestimento in tessuto

Wood frame, fabric covering





 KD
 79cm 54cm 45cm 44cm

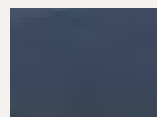

B



V

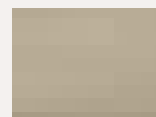

LG

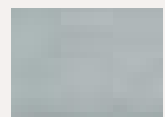

PE



1858 - RE10
(L120 x P45 x H86 cm)



1859 - RE11
(L60 x P45 x H86 cm)



1860 - RE12
(L45 x P45 x H86 cm)

Struttura in legno, rivestimento in ecopelle o tessuto
Wood frame, synthetic leather or fabric covering

Ecopelle, tessuto, base e misure possono essere personalizzate
Synthetic leather, fabric, base and sizes can be customized



1852 - RE04
(L120 x P45 x H101 cm)



1853 - RE05
(L60 x P45 x H101 cm)



1854 - RE06
(L45 x P45 x H101 cm)

Struttura in legno, rivestimento in ecopelle o tessuto
Wood frame, synthetic leather or fabric covering

Ecopelle, tessuto, base e misure possono essere personalizzate
Synthetic leather, fabric, base and sizes can be customized



1951 - RE13
(L120 x P45 x H101 cm)



1952 - RE14
(L60 x P45 x H101 cm)



1953 - RE15
(L45 x P45 x H101 cm)

Struttura in legno, rivestimento in ecopelle o tessuto
Wood frame, synthetic leather or fabric covering

Ecopelle, tessuto, base e misure possono essere personalizzate
Synthetic leather, fabric, base and sizes can be customized



1855 - RE07
(L120 x P45 x H101 cm)



1856 - RE08
(L60 x P45 x H101 cm)



1857 - RE09
(L45 x P45 x H101 cm)

Struttura in legno, rivestimento in ecopelle o tessuto
Wood frame, synthetic leather or fabric covering

Ecopelle, tessuto, base e misure possono essere personalizzate
Synthetic leather, fabric, base and sizes can be customized



1849 - RE01
(L120 x P45 x H130 cm)



1850 - RE02
(L60 x P45 x H130 cm)



1851 - RE03
(L45 x P45 x H130 cm)

Struttura in legno, rivestimento in ecopelle o tessuto
Wood frame, synthetic leather or fabric covering

Ecopelle, tessuto, base e misure possono essere personalizzate
Synthetic leather, fabric, base and sizes can be customized

FINITURE BASI BASE FINISHES



Base (A)

Rivestimento in laminato,
colore a richiesta

Laminate coating, color on request

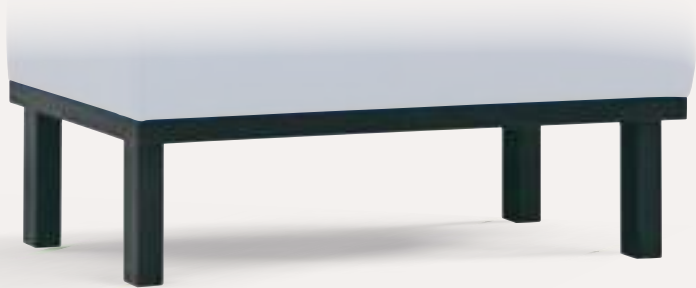

Base (B)

Struttura a vista in legno con gambe
quadrate in legno, colore a richiesta

*Visible wooden structure with square
wooden legs, color on request*



Base (C)

Gambe in legno rettangolari,
colore a richiesta

*Rectangular wooden legs,
color on request*



Base (D)

Gambe rotonde in metallo,
colore a richiesta

Round metal legs, color on request



POLTRONCINA *ARMCHAIR*
1902 - RD01



TAVOLO *TABLE*
1922 - ZL02
(L70 x P70 x H77 cm) KD
1921 - ZL01
(L80 x P80 x H77 cm) KD

Struttura in metallo verniciato,
piano in melamina

*Powder coated metal frame,
melamine top*



W



N



1966 - TB9



1967 - TB10



1968 - TB11



1969 - TB12



1962 - TB5



1963 - TB6



1964 - TB7



1965 - TB8



1958 - TB1



1959 - TB2



1960 - TB3



1961 - TB4



537 - CS205
(Ø 70 x H75 cm)



1840 - BT2G
(Ø 60 x H110 cm)



538 - CS206
(70 x 70 x H 75 cm)

621 - CS207
(80 x 80 x H 75 cm)

Struttura in acciaio inox cromato, piedini regolabili
piano in vetro temperato spessore 12 mm
*Chromed stainless steel frame,
12 mm tempered glass, adjustable feet*

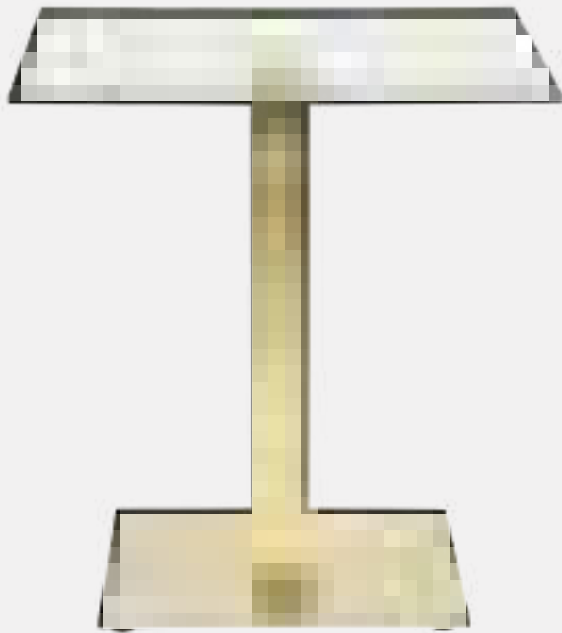

1770 - F39G
(70 x 70 x H 75 cm)

1956 - F40G
(80 x 80 x H 75 cm)



1768 - F43G
(Ø 60 cm H 75 cm)

Struttura in acciaio inox ottonato, piano in vetro temperato, spessore 12 mm
Metal frame, gold effect, 12 mm tempered glass top



1771 - F39B
(70 x 70 x H 75 cm)

1957 - F40B
(80 x 80 x H 75 cm)



1769 - F43B
(Ø 60 cm H 75 cm)

Struttura in acciaio inox in ottone satinato, piedini regolabili, piano in vetro temperato, spessore 12 mm
Stainless steel frame, satin gold effect, 12 mm tempered glass top, adjustable feet



938 - K54 (L80 x P80 x H74 cm)

939 - K55 (L120 x P80 x H74 cm)

Struttura in metallo, gambe in legno di faggio,
piano in MDF laccato

*Powder coated metal frame,
beech solid wood legs, painted MDF top*

piano / top



W

N



841 - RF22

Struttura in metallo verniciato, piano allungabile in cristallo spessore 8 mm

Powder coated metal frame, 8 mm tempered glass top and extension
(100/160 x 70 x 76/45 cm)



W



G







TAVOLO *TABLE*

689 - TF23

Struttura in metallo verniciato,
piano allungabile in vetroceramica spessore
13,5 mm

*Powder coated metal frame,
13,5 mm tempered glass and ceramic, top
and extension*

(L160+40+40 x P90 x H75 cm)

SEDIA *CHAIR* - pg. 146

1615 - TOP8

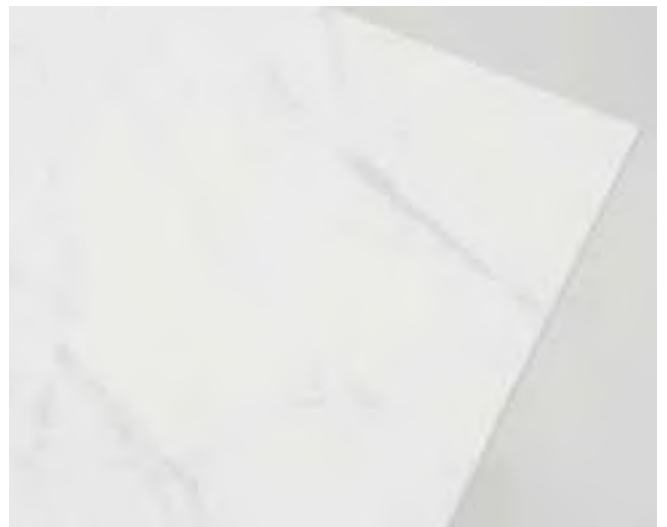



□ TAVOLO *TABLE*
1665 - TF22

Struttura in metallo verniciato, piano allungabile in cristallo e melamina antigraffio spessore 11 mm
Powder coated metal frame, 11 mm tempered glass and scratchproof melamine top and extension
(L160/+40+40 x P90 x H75 cm) KD



□ SEDIA CHAIR - pg. 160
1803 - DC81





- TAVOLO *TABLE*
1737 - DT45

Struttura in metallo verniciato,
piano in vetroceramica spessore 11 mm
*Powder coated metal frame,
11 mm tempered glass and ceramic top*

(L200 x P100 x H75 cm) KD

- POLTRONCINA *ARMCHAIR* - pg. 143
1939 - UK02







☐ SEDIA CHAIR - pg. 160
1803 - DC81

☐ TAVOLO TABLE
1694 - DE93T

Struttura in metallo verniciato, piano allungabile in vetroceramica spessore 13,5 mm
Powder coated metal frame, 13,5 mm tempered glass and ceramic top and extension

(L160/+40+40 x P90 x H76 cm) KD



□ TAVOLO *TABLE*
1442 - A58

Struttura in metallo verniciato, piano allungabile in cristallo spessore 10 mm
Powder coated metal frame, 10 mm tempered glass top and extension
(L180/220 x P90 x H76 cm) KD

□ SEDIA *CHAIR* - pg. 144
1615 - TOP8



struttura / frame



W



G9



□ TAVOLO *TABLE*
1442 - A58

Struttura in metallo verniciato, piano allungabile in cristallo spessore 10 mm
Powder coated metal frame, 10 mm tempered glass top and extension
(L180/220 x P90 x H76 cm) KD

□ SEDIA *CHAIR* - pg. 152
1528 - T07

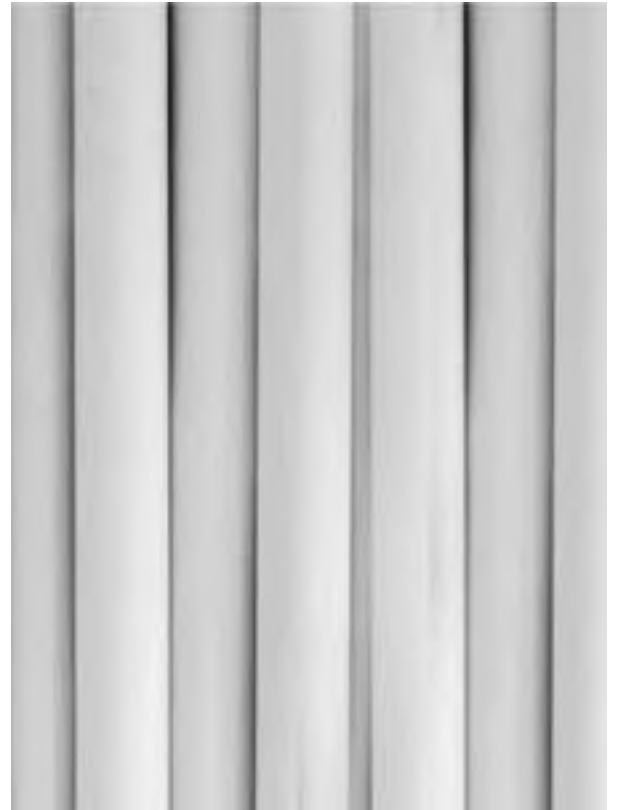

struttura / frame

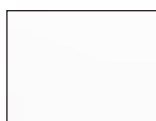

W



G9



□ TAVOLO *TABLE*
1594 - DE86T

Struttura in metallo verniciato, piano allungabile in vetroceramica spessore 11 mm, estensione in MDF laccata
Powder coated metal frame, 11 mm tempered glass and ceramic top, high gloss MDF extension
(Ø 120+50 x H76 cm) KD



□ SEDIA CHAIR - pg 146
1615 - TOP8





TAVOLO *TABLE*
1608 - TOP1

Struttura in metallo verniciato, gambe in legno,
piano allungabile in vetroceramica spessore 11 mm

*Powder coated metal frame, solid wood legs,
11 mm tempered glass and ceramic top and extension*
(L180/230 x P90 x H75 cm) KD

SEDIA *CHAIR* - pg. 158
1927 - TD03





SEDIA CHAIR - pg. 162
821 - RF49C

TAVOLO TABLE
1609 - TOP2

Struttura in alluminio, gambe in legno, piano allungabile in cristallo spessore 10 mm
Aluminum frame, solid wood legs, 10 mm tempered glass top
(L160/+40+40 x P90 x H75 cm) KD





□ TAVOLO *TABLE*
1324 - A75

Struttura in metallo verniciato, gambe in legno di faggio, piano allungabile in MDF verniciato effetto pietra
Powder coated metal frame beech, wood legs, MDF top and extension painted in stone color
(L160/220 x P90 x H76 cm) KD

□ POLTRONCINA *ARMCHAIR* - pg. 171
1523 - D23





□ TAVOLO TABLE
1445 - A75G

Struttura in metallo verniciato, gambe in legno, piano allungabile in cristallo spessore 10,5 mm
Powder coated metal frame, wood legs, 10,5 mm tempered stoneglass top and extension
(L140/200 x P80 x H76 cm)

□ POLTRONCINA ARMCHAIR - pg. 118
1904 - RD03

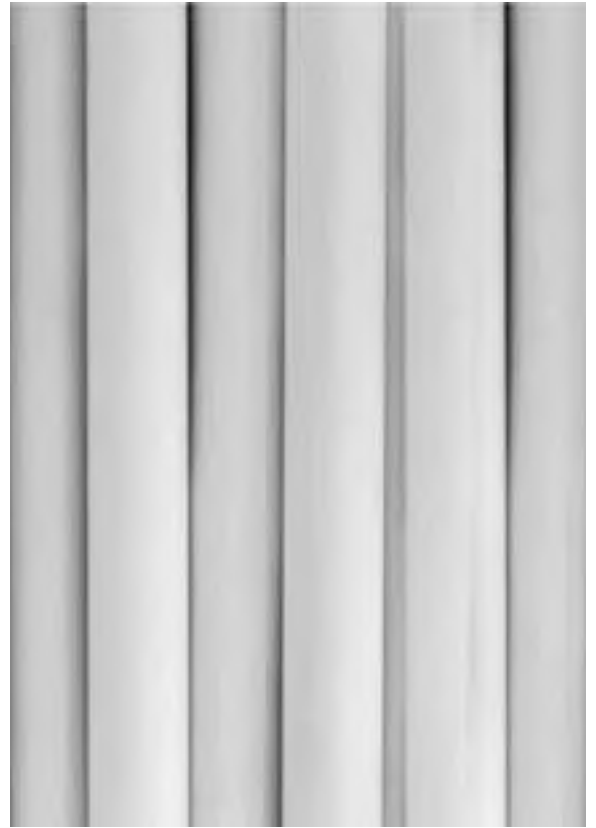

POLTRONCINA *ARMCHAIR* - pg. 171
1523 - D223

SEDIA *CHAIR* - pg. 171
1524 - D22



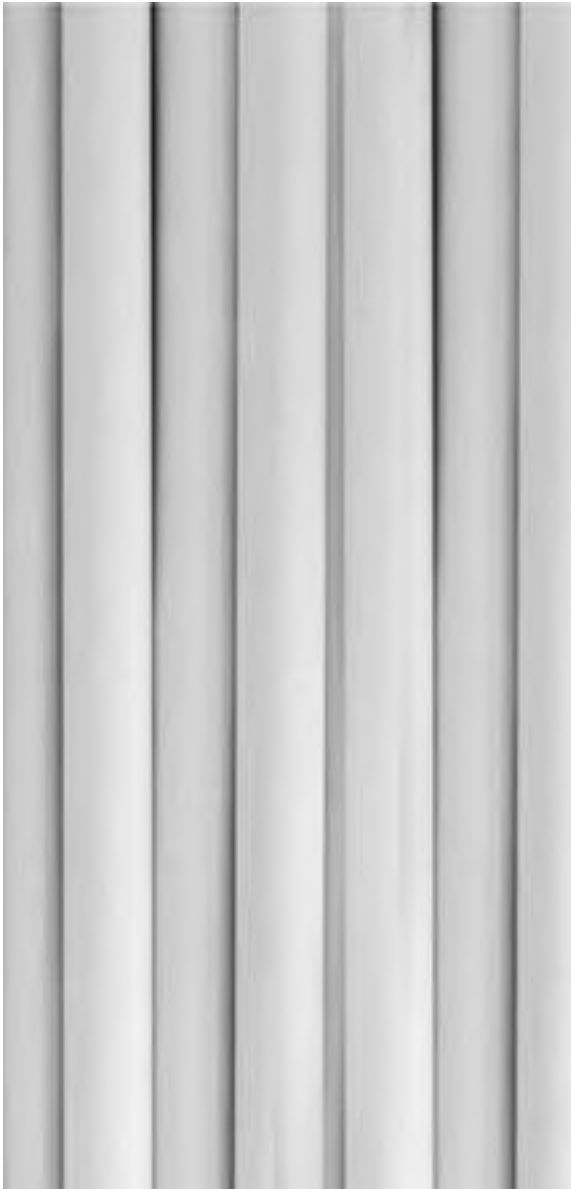



- TAVOLO *TABLE*
1801 - MT49

Struttura in legno massello, piano in MDF impiallacciato
Solid rubber wood frame, MDF veneer top
(L160 x P90 x H75 cm)

- POLTRONCINA *ARMCHAIR* - pg. 118
1904 - RD03



TAVOLO *TABLE*
1677 - MIT10

Struttura in metallo verniciato, piano in MDF impiallacciato
Powder coated metal frame, MDF top with ash veneer
(Ø 137 x H76 cm)

POLTRONCINA *ARMCHAIR* - pg. 149
1904 - RD03

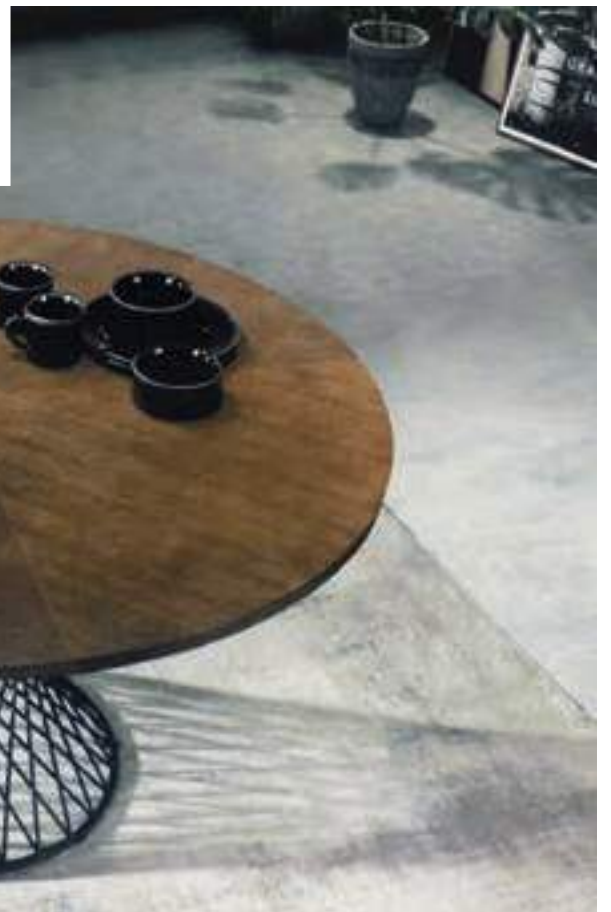



□ TAVOLO TABLE
1676 - MIT67

□ POLTRONCINA ARMCHAIR - pg. 148
1954 - E14

Struttura in metallo verniciato, piano in marmo sintetico
Powder coated metal frame, synthetic marble top

(Ø 135 x H75 cm)

marmo / marble



W N

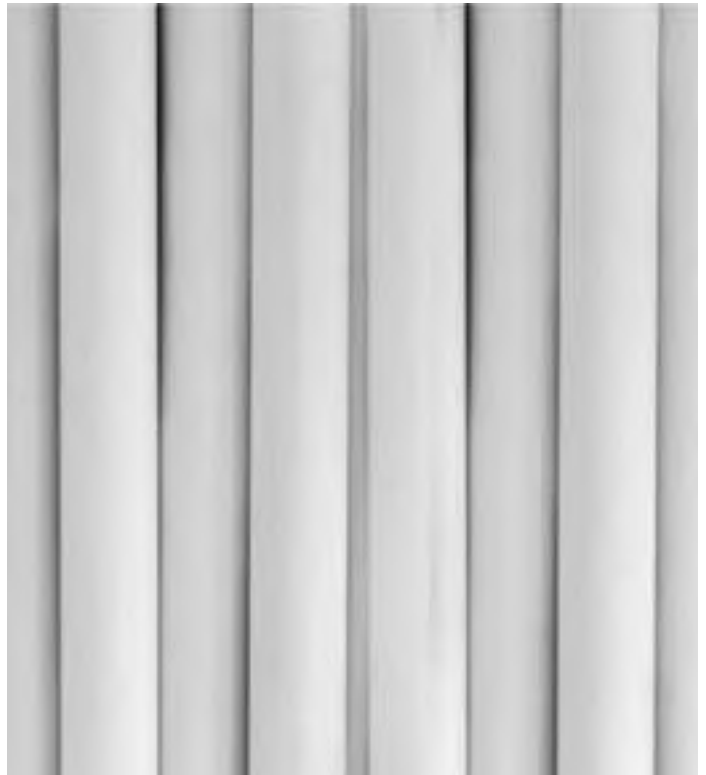



SEDIA CHAIR - pg. 166
1456 - 30D

TAVOLO TABLE
1450 - 28DT

Struttura in metallo verniciato, piano allungabile in cristallo spessore 8 mm, estensione in MDF laccata

Powder coated metal frame, 8 mm tempered glass top, extension in MDF painting

(L140/+45+45 x P90 x H76 cm)



cristallo / tempered glass



W



G9G

struttura & MDF / frame & MDF

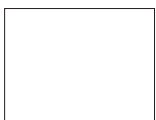

W



G9







SEDIA CHAIR - pg. 183
464 - V11

TAVOLO TABLE
1457 - 65DT

Struttura in metallo verniciato, piano allungabile in MDF laccato
Powder coated metal frame, top and extension in high gloss MDF
(L130/+40+40 x P80 x H76 cm)

piano MDF / MDF top

struttura / frame

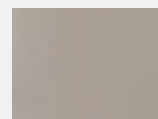
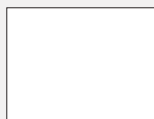

W

G9G



W

G9





SEDIA *CHAIR* - pg. 88
1893 - DH01

TAVOLO *TABLE*
1460 - 78DT

Struttura in metallo verniciato, piano allungabile in cristallo spessore 8 mm
Powder coated metal frame, 8 mm tempered glass top and extension
(L120/+45+45 x P86 x H75 cm)

cristallo / *tempered glass*

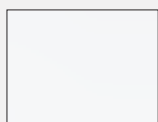

W

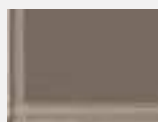

G10G

struttura / *frame*



W



G10





□ TAVOLO TABLE
1466 - 73DTM

Struttura in metallo verniciato,
piano allungabile in vetroceramica
temperato spessore 11,5 mm

*Powder coated metal frame,
11,5 mm ceramic tempered
glass top and extension
(L120/170 x P80 x H76 cm)*

□ SEDIA CHAIR - pg. 183
464 - V11





□ TAVOLO *TABLE*
1467 - 73DTN

Struttura in metallo verniciato, piano allungabile
in vetro-melamina temperato resistente al fuoco
spessore 8,5 mm

*Powder coated metal frame,
8,5 mm melamine tempered
glass top and extension, fire resistant
(L120/170 x P80 x H76 cm)*

□ SEDIA *CHAIR* - pg. 68
451 - P82



Interno

Indoor



**Basi & piani
per tavoli**

***Table bases
& tops***



1648 - EG3
 Struttura in acciaio inox ottonato
Stainless steel frame, gold effect
 (52 x 52 x H72 cm) kg 3,7



1647 - EC1
 Struttura in acciaio inox cromato
Chromed stainless steel frame
 (52 x 52 x H72 cm) kg 3,7



1839 - EP1
 Struttura in acciaio inox verniciato
Powder coated stainless steel frame
 (L52 x P52 x H72 cm) kg 3,7





980 - TB015S (L80 x P80 x H72,5 cm) KD

986 - TB016S (L120 x P80 x H72,5 cm) KD

Struttura in metallo cromato

Chromed metal frame



988 - TB015V (L80 x P80 x H72,5 cm) KD

987 - TB016V (L120 x P80 x H72,5 cm) KD

Struttura in metallo verniciato

Powder coated metal frame



□ STRUTTURA *FRAME*

530 - LX188
(L80 x P80 x H74,5 cm) KD

532 - LX288
(L120 x P80 x H74,5 cm) KD

533 - LX388
(L160 x P80 x H74,5 cm) KD

534 - LX488
(L180 x P90 x H74,5 cm) KD

Struttura in alluminio verniciato
Powder coated aluminum frame





□ STRUTTURA FRAME

517 - LX191
(L80 x P80 x H73,5 cm) KD

518 - LX291
(L120 x P80 x H73,5 cm) KD

519 - LX391
(L160 x P80 x H73,5 cm) KD

527 - LX491
(L180 x P90 x H73,5 cm) KD

Struttura in alluminio verniciato
Powder coated aluminum frame



W

N

G



□ STRUTTURA FRAME

506 - LX194
(L80 x P80 x H72,5 cm) KD

514 - LX294
(L120 x P80 x H72,5 cm) KD

515 - LX394
(L160 x P80 x H72,5 cm) KD

516 - LX494
(L180 x P90 x H72,5 cm) KD

Struttura in alluminio verniciato
Powder coated aluminum frame



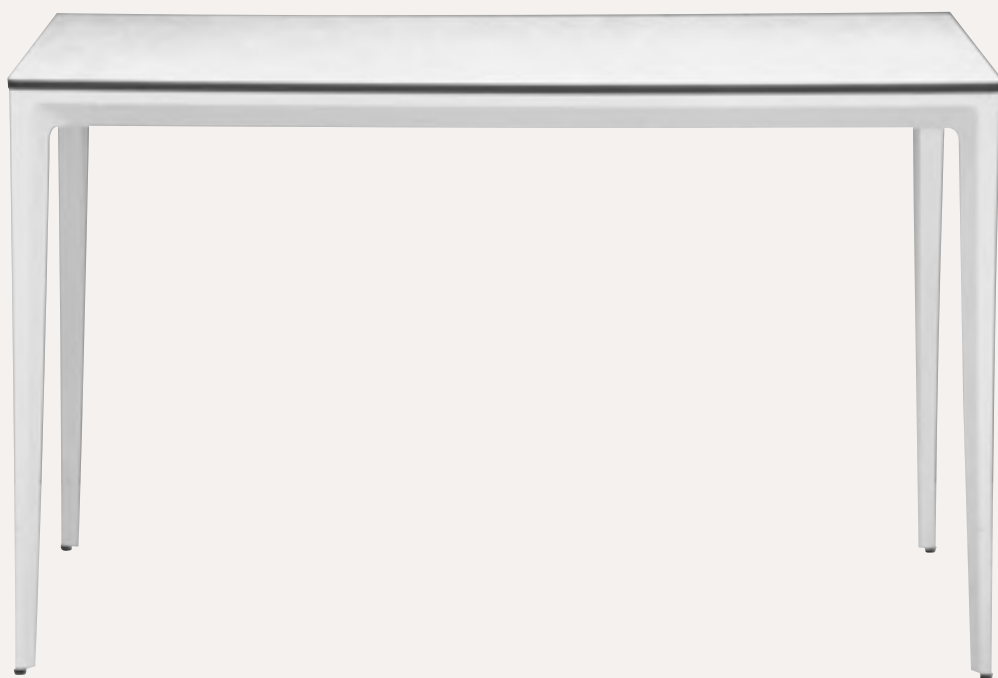

□ STRUTTURA *FRAME*

500 - LX192
(L80 x P80 x H72,5 cm) KD

501 - LX292
(L120 x P80 x H72,5 cm) KD

502 - LX392
(L160 x P80 x H72,5 cm) KD

503 - LX192
(L180 x P90 x H72,5 cm) KD

Struttura in alluminio verniciato
Powder coated aluminum frame



W

N

G



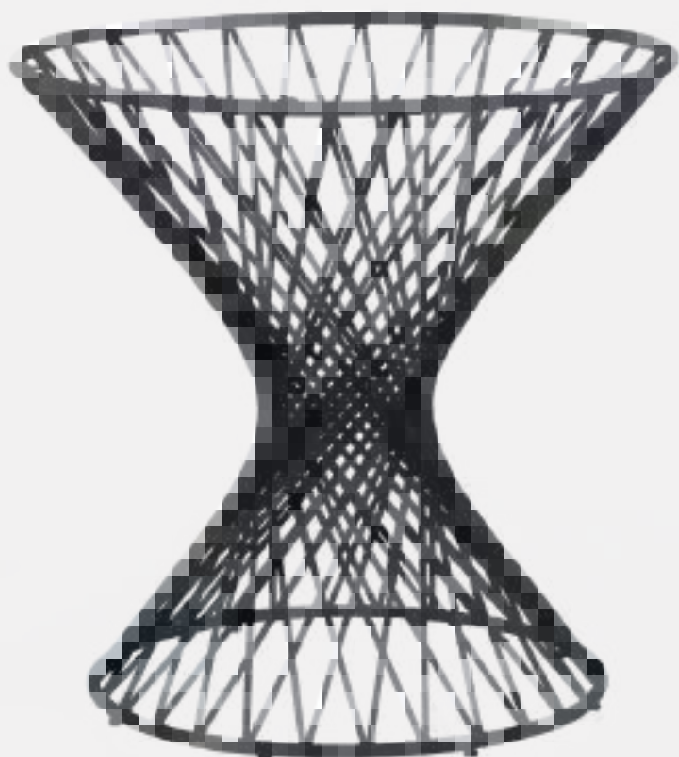
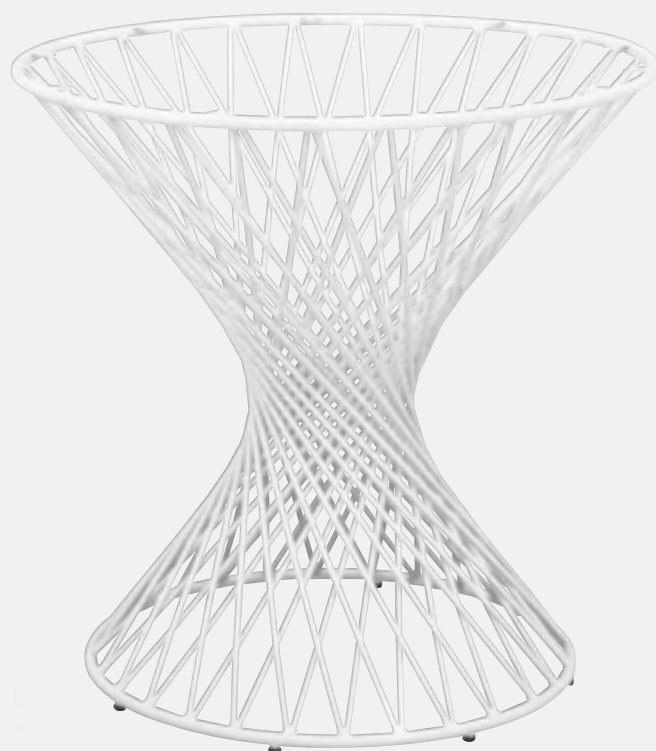
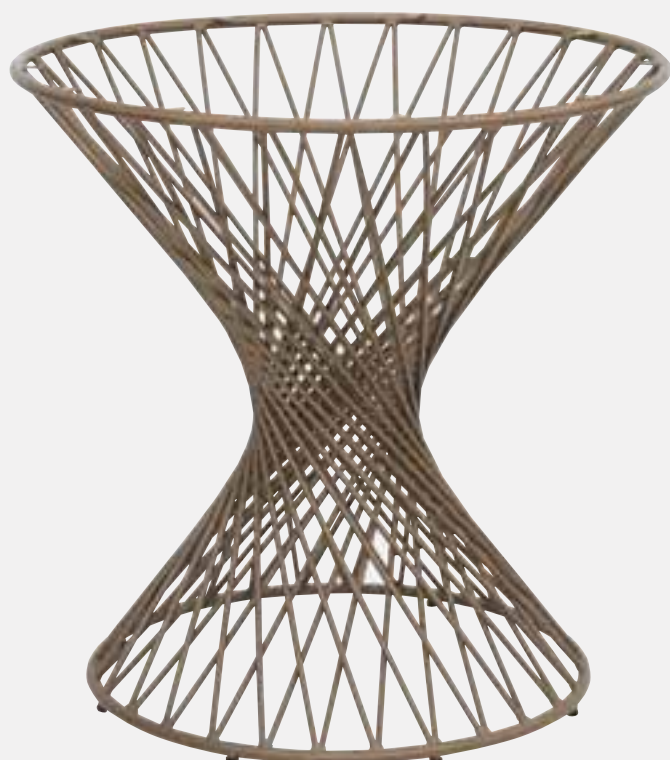

1985 - MB01

Base in metallo verniciato

Powder coated metal base

(Ø 75 x H74,5 cm) kg 22,4



W

N

BR



494 - FN1
(Ø 51 x H71 cm)

495 - FN2
(Ø 60 x H71 cm)

Struttura in metallo verniciato
Powder coated metal frame



W N



496 - FN3
(Ø 51 x H71 cm)

497 - FN4
(Ø 60 x H71 cm)

Struttura in acciaio inox
Stainless steel frame





485 - EB1

Struttura in acciaio inox, tubo nero,
base ottone satinato, piedini regolabili

*Stainless steel frame, black tube,
base in satin brass colour, adjustable feet*

(40 x 40 x H72 cm) kg 14 KD



486 - EB2

Struttura in acciaio verniciata,
effetto legno, piedini regolabili

*Steel frame, wood effect,
adjustable feet*

(40 x 40 x H72 cm) kg 14 KD





488 - EB3
(40 x 40 x H72 cm) kg 14 KD

489 - EB4
(Ø 40 x H72 cm) kg 11,5 KD



Struttura in acciaio inox ramato, piedini regolabili / *Stainless steel frame, copper effect, adjustable feet*

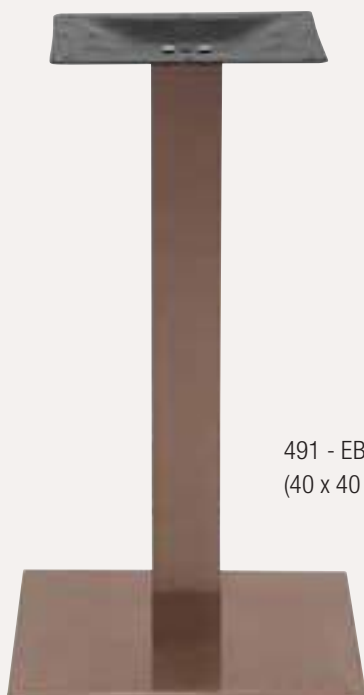

491 - EB4
(40 x 40 x H72 cm) kg 14 KD

492 - EB6
(Ø 40 x H72 cm) kg 11,5 KD



Struttura in acciaio inox rame satinato, piedini regolabili / *Stainless steel frame, satin copper, adjustable feet*



1646 - EG2
(Ø 40 x H72 cm) kg 11,5 KD

1645 - EG1
(40 x 40 x H72 cm) kg 14 KD

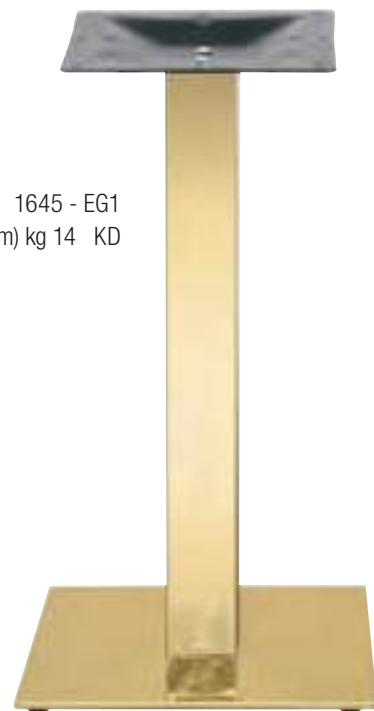

Struttura in acciaio inox ottonato, piedini regolabili / *Stainless steel frame, gold effect, adjustable feet*



1833 - GH2
(Ø 40 x H110 cm) kg 13,5 KD

1834 - GH1
(40 x 40 x H110 cm) kg 17 KD

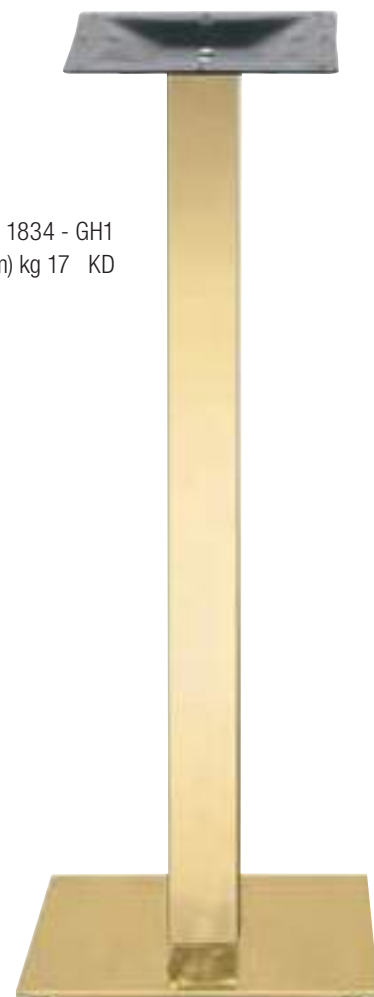



1835 - GS2
(Ø 40 x H72 cm) kg 11,5 KD

1837 - GS1
(40 x 40 x H72 cm) kg 14 KD



Struttura in acciaio inox effetto ottone satinato, piedini regolabili / *Stainless steel frame, satin gold effect, adjustable feet*



1836 - SH2
(Ø 40 x H110 cm) kg 13,5 KD

1838 - SH1
(40 x 40 x H110 cm) kg 17 KD



398 - 6029I

Struttura in acciaio inox satinato,
piedini regolabili*Satin stainless steel frame,
adjustable feet*

(Ø 40 x H110 cm) kg 13,5 KD



399 - 6029C

Struttura in acciaio inox cromato,
piedini regolabili*Chromed stainless steel frame,
adjustable feet*

(Ø 40 x H110 cm) kg 13,5 KD

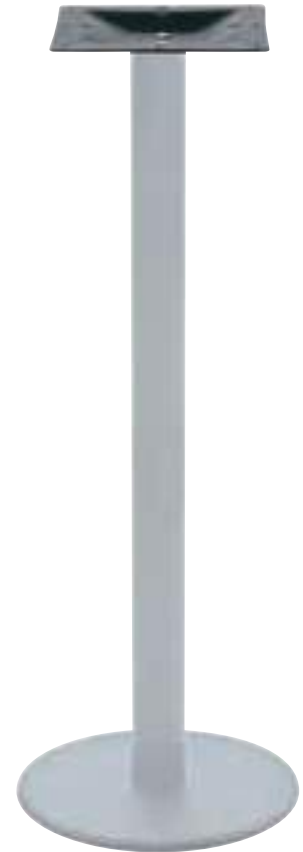

748 - 34040H

Struttura in acciaio verniciata,
piedini regolabili*Powder coated steel frame,
adjustable feet*

(Ø 40 x H110 cm) kg 13,5 KD



411 - 6028I
(Ø 40 x H73 cm) kg 12 KD

1272 - 6050L
(Ø 50 x H73 cm) kg 15 KD

771 - E18SG
(Ø 58 x H73 cm) kg 18 KD

Struttura in acciaio inox satinato,
piedini regolabili

*Satin stainless steel frame,
adjustable feet*



414 - 6028C
(Ø 40 x H73 cm) kg 12 KD

405 - DC400C
(Ø 50 x H73 cm) kg 15 KD

407 - DC600C
(Ø 58 x H73 cm) kg 18 KD

Struttura in acciaio inox
cromato, piedini regolabili

*Chromed stainless steel frame,
adjustable feet*

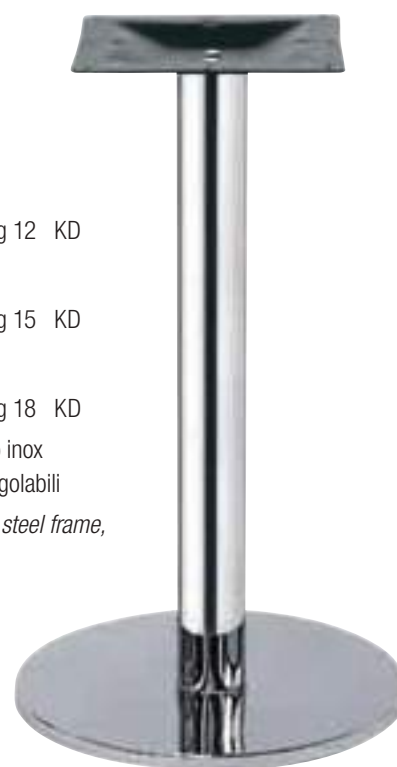

360 - 340N
(Ø 40 x H72 cm) kg 14 KD

176 - 341N
(Ø 60 x H72 cm) kg 18 KD

Struttura in acciaio verniciato,
piedini regolabili

*Powder coated steel frame,
adjustable feet*

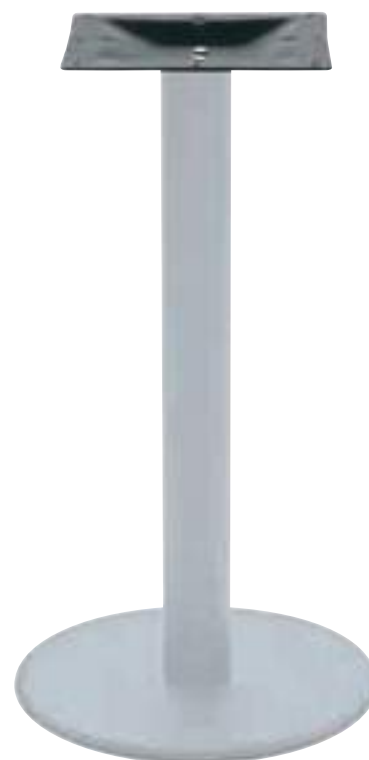

400 - 339HI

Struttura in acciaio inox satinato,
piedini regolabili*Satin stainless steel frame,
adjustable feet*

(40 x 40 x H108 cm) kg 17 KD

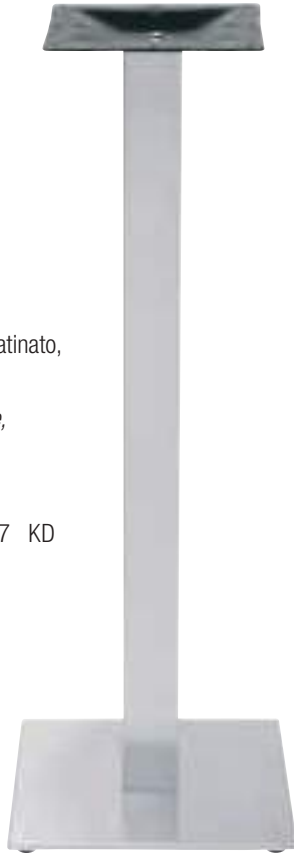

401 - 339HC

Struttura in acciaio inox cromato,
piedini regolabili*Chromed stainless steel frame,
adjustable feet*

(40 x 40 x H108 cm) kg 17 KD

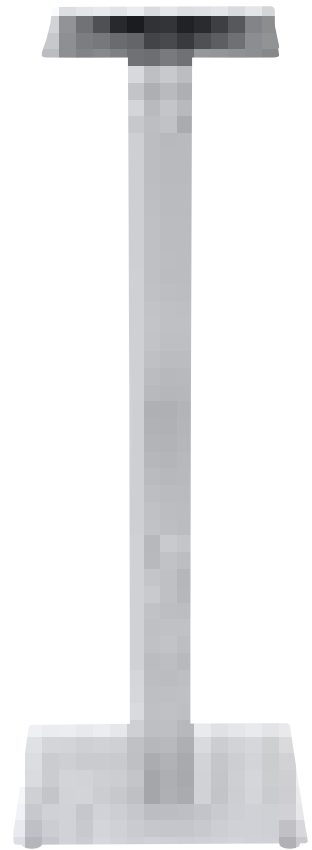
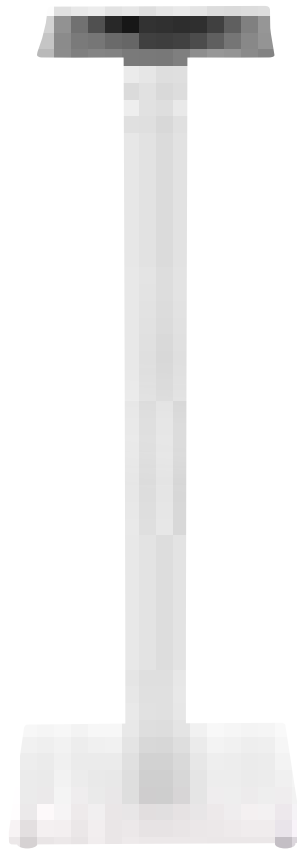
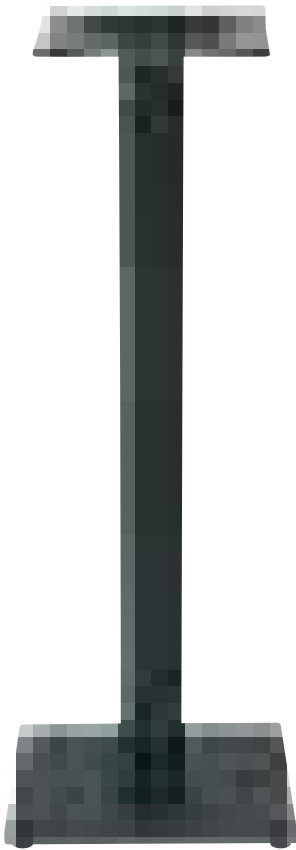
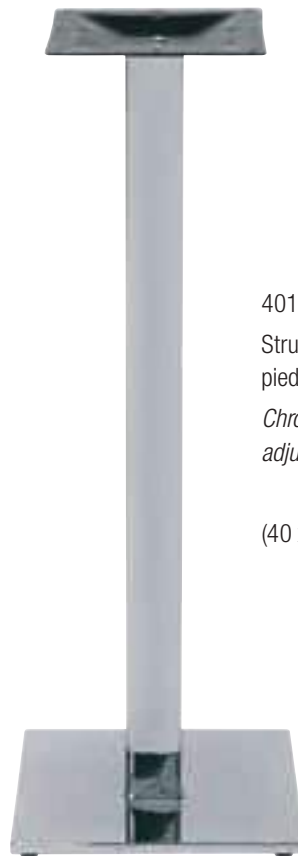

749 - 33940H

Struttura in acciaio verniciata, *Powder coated steel frame,*
piedini regolabili *adjustable feet*

(40 x 40 x H108 cm) kg 17 KD



363 - 6032I
(40 x 40 x H72 cm) kg 15 KD

1572 - 6034I
(50 x 50 x H72 cm) kg 22 KD

Struttura in acciaio inox satinato,
piedini regolabili

*Satin stainless steel frame,
adjustable feet*



364 - 6032C
(40 x 40 x H72 cm) kg 15 KD

1571 - 6034C
(50 x 50 x H72 cm) kg 22 KD

Struttura in acciaio inox cromato,
piedini regolabili

*Chromed stainless steel frame,
adjustable feet*

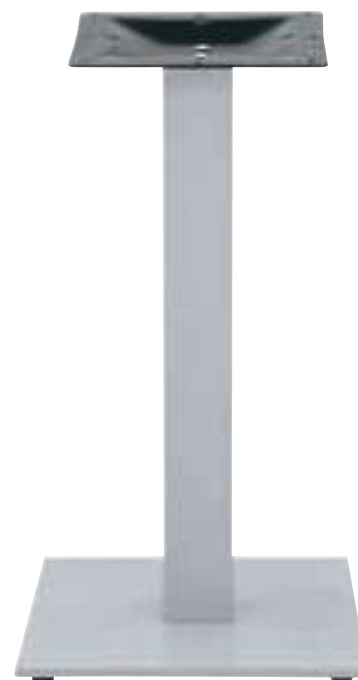
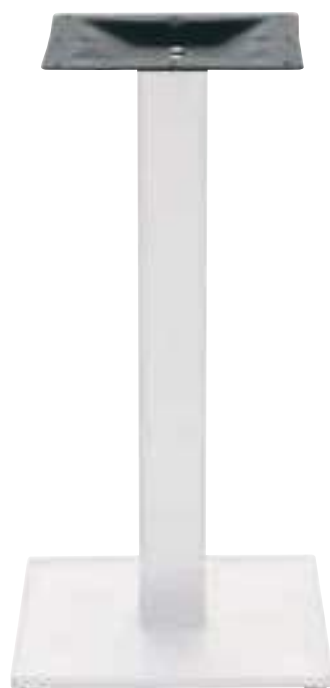

365 - 340N
(40 x 40 x H72 cm) kg 14 KD

1276 - 350N
(50 x 50 x H72 cm) kg 22 KD

Struttura in acciaio verniciata,
piedini regolabili

*Powder coated steel frame,
adjustable feet*



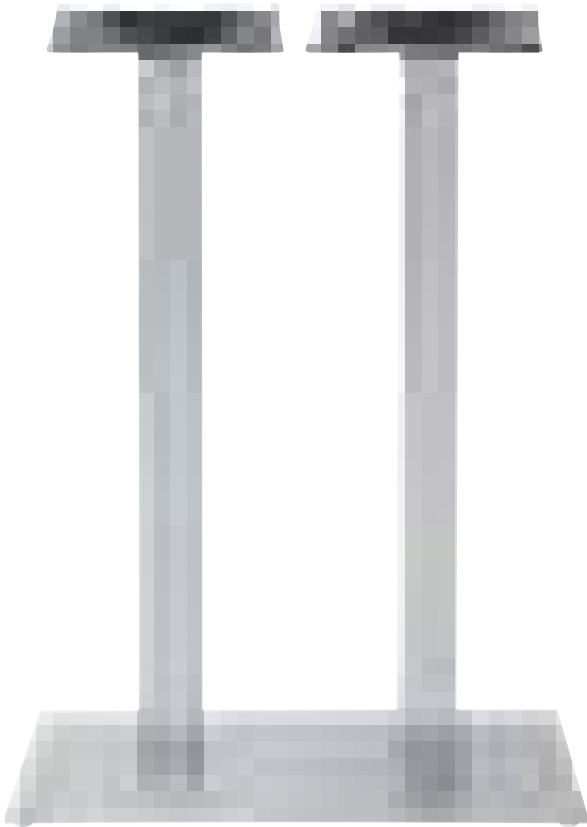

1576 - 6033IH

Struttura in acciaio inox satinato, piedini regolabili
Satin stainless steel frame, adjustable feet
 (40 x 75 x H108 cm) kg 35 KD



1577 - 341CH

Struttura in acciaio inox cromato, piedini regolabili
Chromed stainless steel frame, adjustable feet
 (40 x 75 x H108 cm) kg 35 KD



1578 - 341MH

Struttura in acciaio verniciato, piedini regolabili
Powder coated steel frame, adjustable feet
 (40 x 70 x H108 cm) kg 30 KD

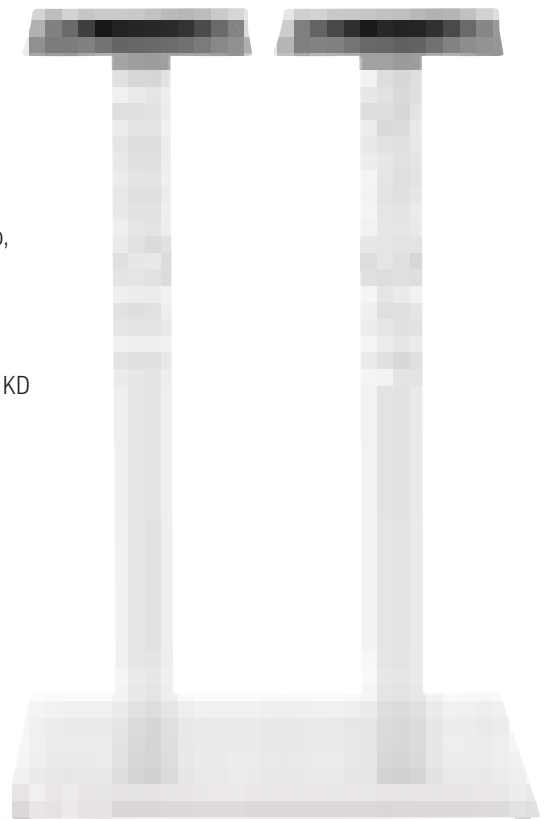



402 - 6033I

Struttura in acciaio inox satinato, piedini regolabili

Satin stainless steel frame, adjustable feet

(40 x 75 x H73 cm) kg 33 KD



773 - 341C

Struttura in acciaio inox cromato, piedini regolabili

Chromed stainless steel frame, adjustable feet

(40 x 70 x H72 cm) kg 33 KD



403 - 341M

Struttura in acciaio verniciata,
piedini regolabili

*Powder coated steel frame,
adjustable feet*

(40 x 70 x H72 cm) kg 28 KD





731 - SH01

Struttura in metallo verniciato, piedini regolabili

Powder coated metal frame, adjustable feet

(40 x 40 x H72 cm) kg 12 KD



366 - 313

Struttura in ghisa verniciata, piedini regolabili

Powder coated cast iron frame, adjustable feet

(Ø 42,5 x H73 cm) kg 18 KD



779 - TB131

Struttura in acciaio verniciato, piedini regolabili

Powder coated metal frame, adjustable feet

(40 x 60 x H73 cm) kg 19 KD



296 - SH12
(40 x 40 x H72 cm) kg 14 KD

Struttura in acciaio ruggine, piedini regolabili
Original rusty metal frame, adjustable feet



305 - SH13
(40 x 40 x H110 cm) kg 17 KD



1351 - T11BR
(H71 cm) kg 12,5 KD



Struttura in ghisa verniciata,
effetto bronzo, piedini regolabili
*Powder coated cast iron frame,
bronze look, adjustable feet*

1353 - T11HBR
(H108 cm) kg 15 KD

169 - CI155-3
(H 71cm) kg 11,5 KD



170 - CI155-4
(H 71cm) kg 12,5 KD

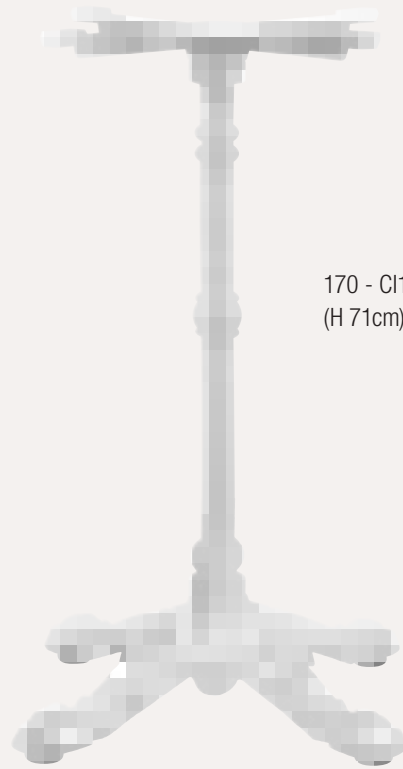

Struttura in ghisa verniciata, piedini regolabili
Powder coated cast iron frame, adjustable feet

660 - 210H
(H 108 cm) kg 15 KD

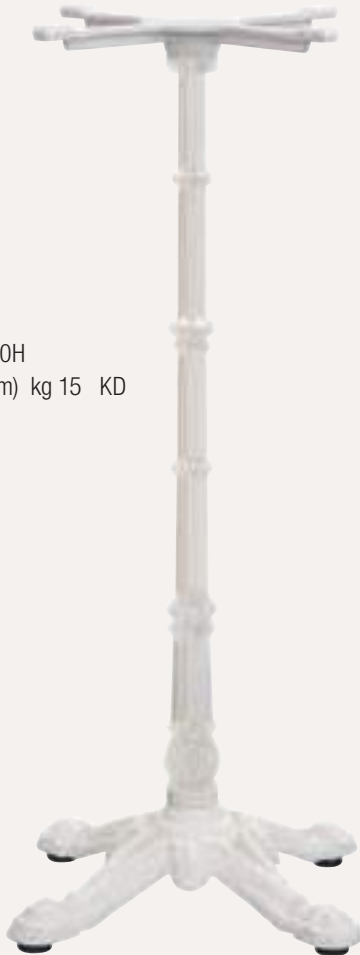

661 - 205H
(H 108 cm) kg 13,5 KD





152 - CA101 (H 70 cm) KD



154 - CA101B (H 70 cm) KD



153 - CA102 (H 70 cm) KD

1273 - CA108 (H 108 cm) KD



155 - CA102B (H 70 cm) KD

Struttura in alluminio verniciato , piedini regolabili
Powder coated aluminum frame, adjustable feet

Struttura in alluminio verniciato effetto bambù, piedini regolabili
Powder coated aluminum frame, bamboo look, adjustable feet

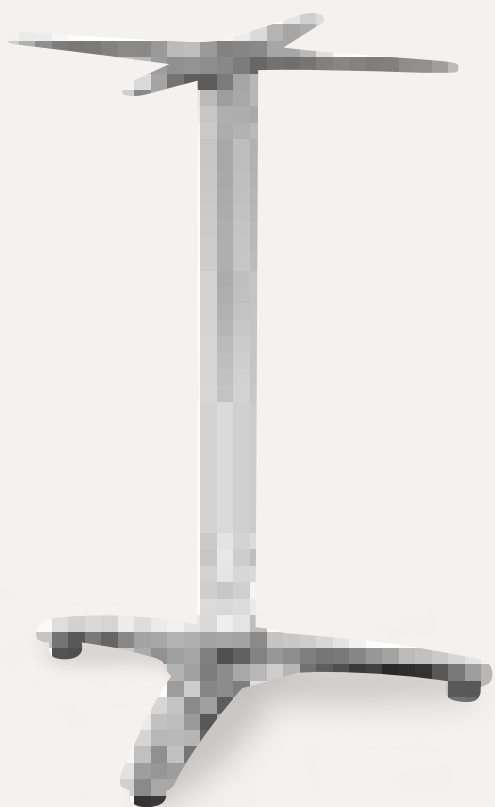

179 - CS2013
(H 71 cm) Kg 6,5 KD

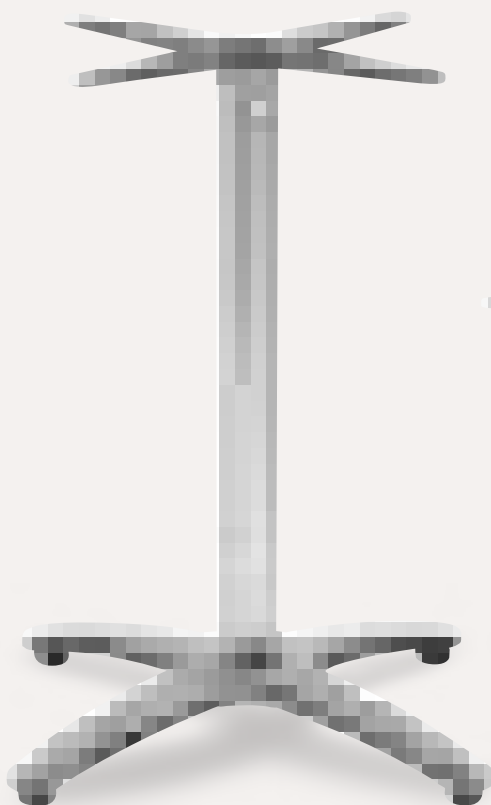

180 - CS2014
(H 71 cm) Kg 8,5 KD

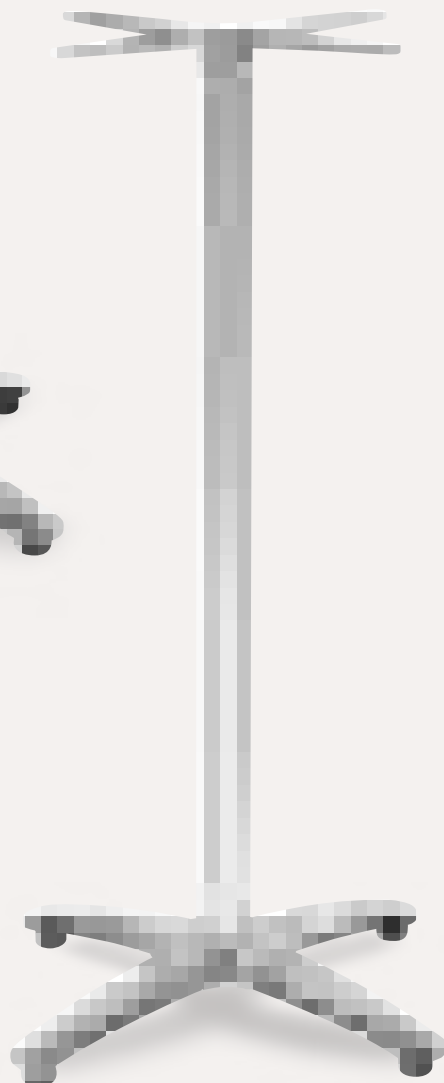

450 - MTB012
(H 108 cm) Kg 9,5 KD



919 - MTB014
(H 71 cm) Kg 9,10 KD

Struttura in alluminio,
acciaio e ghisa, piedini regolabili
*Stainless steel covering base
and aluminum tube, adjustable feet*



611 - F3

Struttura in alluminio accatastabile
con accessorio pieghevole,
piedini regolabili

*Stackable aluminum frame,
adjustable feet*

(H 72 cm) kg 6,2 KD



1341 - E91

Struttura in alluminio accatastabile
con accessorio pieghevole,
piedini regolabili

*Stackable aluminum frame,
adjustable feet*

(H70 cm) KD





774 - HF3

Struttura in alluminio accatastabile con accessorio pieghevole, piedini regolabili
*Stackable aluminum frame,
adjustable feet*

(H 110 cm) kg 6,8 KD



W

AL

N

T



186 - HF4
(H109 cm)

Struttura in polipropilene e metallo verniciato,
crocetta in resina, piedini regolabili
*Polypropylene frame and powder coated metal,
resin cross, adjustable feet*



185 - F4
(H74 cm)



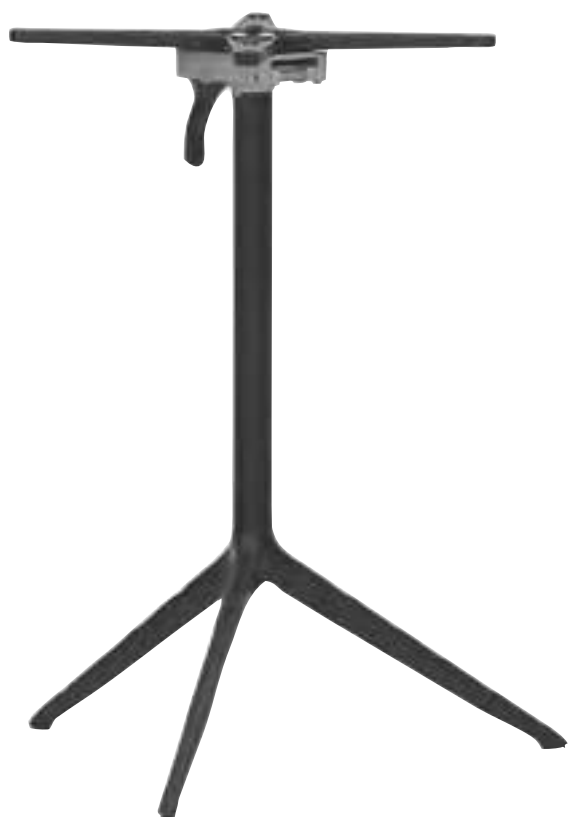

692 - C57

Struttura in alluminio verniciato
accatastabile con accessorio pieghevole

Stackable aluminum frame, powder coated
(H73 cm)

973 - TP

Struttura in alluminio verniciato,
piedini regolabili

*Powder coated aluminum frame,
adjustable feet*

(H 70 cm) kg 7,3 KD



920 - MTB013

Struttura in alluminio verniciato,
piedini regolabili

*Powder coated aluminum frame,
adjustable feet*

(H 70 cm) KD





974 - THP

Struttura in alluminio verniciato, piedini regolabili

Powder coated aluminum frame, adjustable feet

(H 110 cm) kg 7,7 KD





138 - L
(H 103 cm) KD

Struttura in alluminio,
piedini regolabili
*Aluminum frame,
adjustable feet*



133 - D
(H 70 cm) KD



136 - B
(H 70 cm) KD

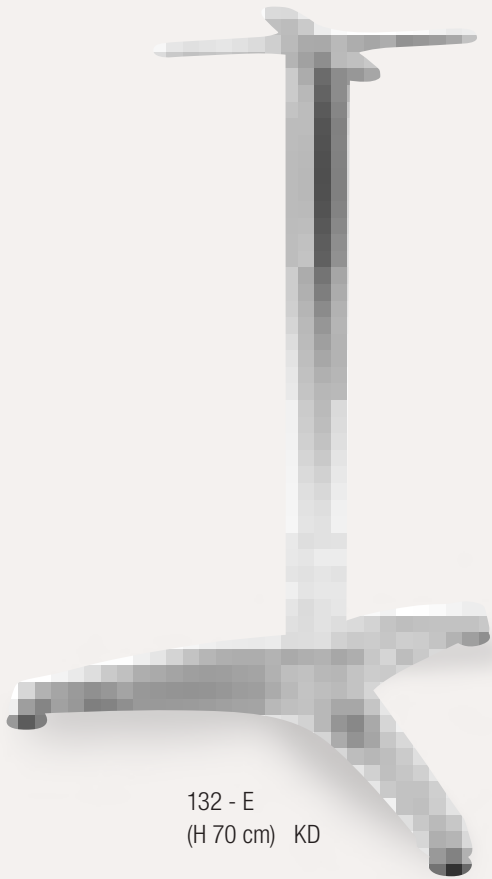

132 - E
(H 70 cm) KD



134 - C
(H 70 cm) KD

135 - A
(H 70 cm) KD



137 - H
(H 103 cm) KD

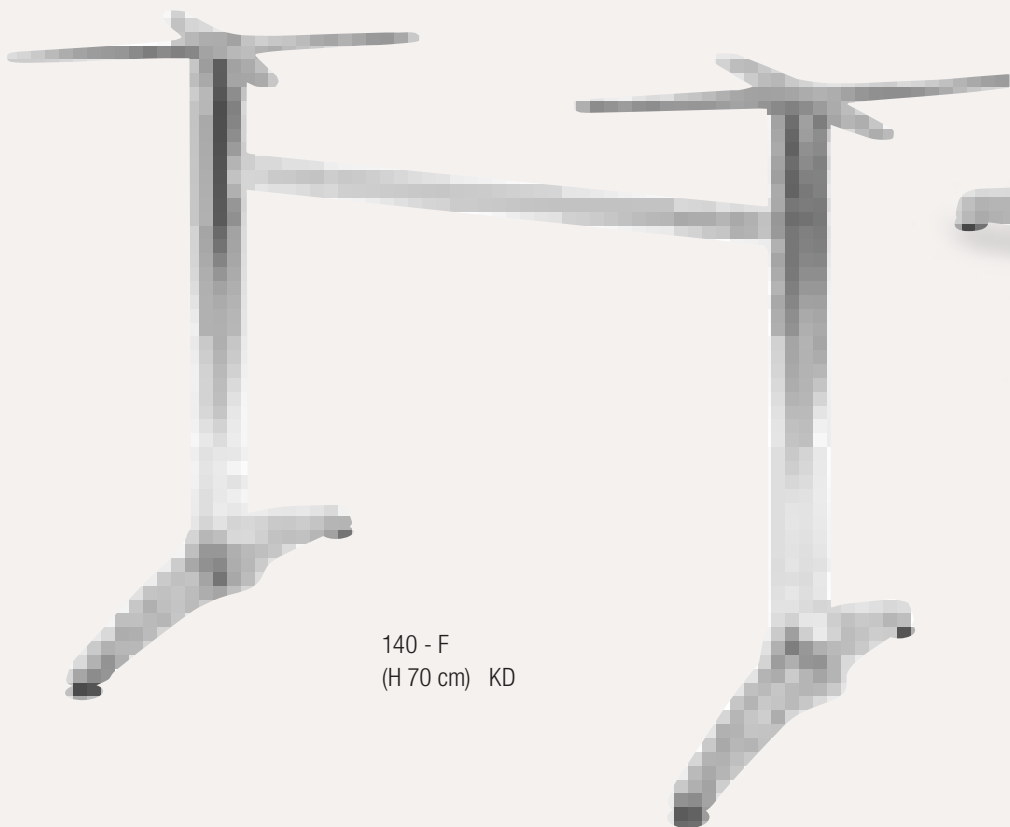

140 - F
(H 70 cm) KD

Struttura in alluminio,
pedini regolabili
*Aluminum frame,
adjustable feet*



141 - NA Struttura in alluminio H71 cm,
tubo Ø 25 x 1,5 mm, per
piano Ø 60 cm
*Aluminum frame H71 cm,
tube Ø 25 x 1,5 mm,
for top Ø 60 cm*

142 - NB Struttura in alluminio H71 cm,
tubo Ø 28x1,8 mm,
per piano Ø 70 cm
*Aluminum frame H71 cm,
tube Ø 28 x 1,8 mm,
for top Ø 70 cm*



143 - OA Struttura in alluminio H71 cm,
tubo Ø 25 x 1,5 mm,
per piano 60 x 60 cm
*Aluminum frame H71 cm,
tube Ø 25 x 1,5 cm,
for top 60 x 60 cm*

144 - OB Struttura in alluminio H71cm,
tubo Ø 28 x 1,8 mm,
per piano 70 x 70 cm
*Aluminum frame H71 cm,
tube Ø 28 x 1,8 mm,
for top 70 x 70 cm*

145 - OC Struttura in alluminio H71 cm,
tubo Ø 28 x 1,8 mm,
per piano 80 x 80 cm
*Aluminum frame H71 cm,
tube Ø 28 x 1,8 mm,
for top 80 x 80 cm*

843 - OD Struttura in alluminio H71 cm,
tubo Ø 28 x 1,8 mm,
per piano 120 x 80 cm
*Aluminum frame H71 cm,
tube Ø 28 x 1,8 mm,
for top 120 x 80 cm*



842 - 6032A

Struttura in alluminio, piedini regolabili / *Aluminum frame, adjustable feet*
(40 x 40 x H73 cm) kg 15 KD

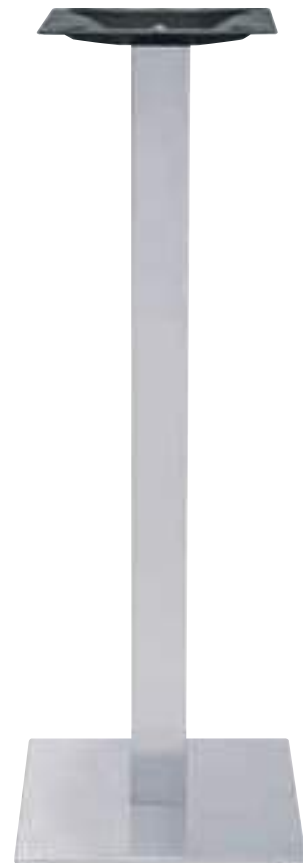
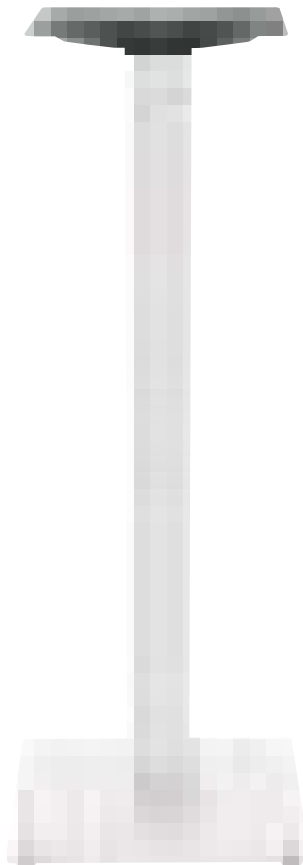
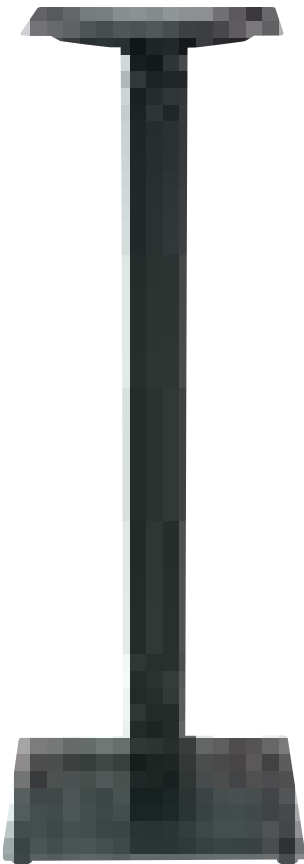

856 - 339HA

Struttura in alluminio, piedini regolabili / *Aluminum frame, adjustable feet*
(40 x 40 x H108 cm) kg 17 KD





1349 - B80

Struttura in polipropilene,
zavorra in metallo

*Polypropylene frame,
ballast metal round plate*

(Ø40 x H72 cm) kg 11 KD



656 - 340R

Base in alluminio, rivestimento
in piattina di polietilene,
piedini regolabili

*Aluminum base, polyethylene
thread covering*

(Ø40 x H72 cm) kg 12,7 KD





- 1412 - TB77 (L70 x P70 x H73 cm) KD
- 1413 - TB78 (L80 x P80 x H73 cm) KD
- 1415 - TB712 (L120 x P80 x H73 cm) KD
- 177 - TB718 (L180 x P90 x H73 cm) KD

Struttura in alluminio verniciato,
piedini regolabili

*Powder coated aluminum frame,
adjustable feet*



PIANI IN STRATIFICATO HPL "EXTRA"
HPL PRESSURE LAMINATE TOPS "EXTRA"



COPPER PAINTED



GREY WOOD



METALLIC



TEX STONE



SLEEK LIGHT GREY



BROOKLYN DARK



KARARA WHITE



OLD PAINT

PIANI IN STRATIFICATO HPL "EXTRA"
HPL PRESSURE LAMINATE TOPS "EXTRA"



BROOKLIN LIGHT



GRAPHITO



GRANITO



STATUARIO

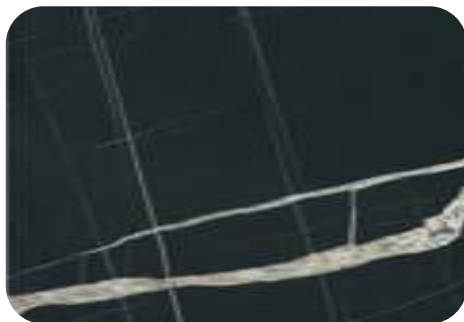

MARMO NERO



AQUA PAINTED METAL



APPLE CRATES



BLU WOOD

PIANI IN STRATIFICATO HPL "EXTRA"
HPL PRESSURE LAMINATE TOPS "EXTRA"

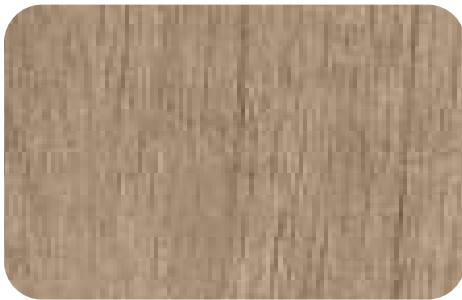

CANYON MONUMENT OAK

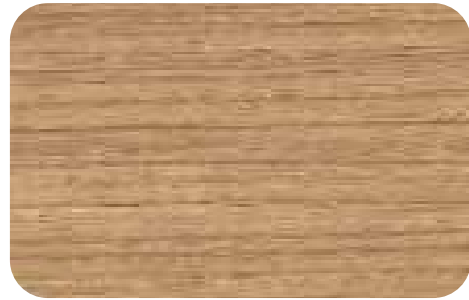

URBAN TEAK



WENGÉ

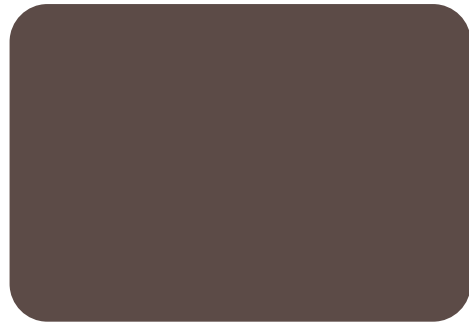

MOKA

spessore / thickness
10 mm

232 - CRT59 (Ø 60 cm)	235 - CST59 (60 x 60 cm)
233 - CRT69 (Ø 70 cm)	236 - CST69 (70 x 70 cm)
234 - CRT79 (Ø 80 cm)	237 - CST79 (80 x 80 cm)
	238 - CST119 (120 x 80 cm)

spessore / thickness
12 mm

284 - BRT59 (Ø 60 cm)	287 - BST59 (60 x 60 cm)
285 - BRT69 (Ø 70 cm)	288 - BST69 (70 x 70 cm)
286 - BRT79 (Ø 80 cm)	289 - BST79 (80 x 80 cm)
477 - BRT90 (Ø 90 cm)	476 - BST90 (90 x 90 cm)
481 - BRT120 (Ø 80 cm)	290 - BST119 (120 x 80 cm)
	291 - BST180 (180 x 90 cm)

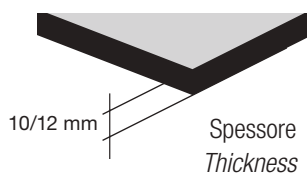

TUTTI I PIANI IN HPL POSSONO ESSERE PERSONALIZZATI
ALL HPL TOPS CAN BE CUSTOMIZED

PIANI IN STRATIFICATO HPL "STANDARD"
HPL PRESSURE LAMINATE TOPS "STANDARD"



BIANCO



TORTORA



NERO / BLACK



ANTRACITE

spessore / thickness 10 mm

1704 - ART59 (Ø 60 cm)	1707 - AST59 (60 x 60 cm)
1705 - ART69 (Ø 70 cm)	1708 - AST69 (70 x 70 cm)
1706 - ART79 (Ø 80 cm)	1709 - AST79 (80 x 80 cm)
	1710 - AST119 (120 x 80 cm)

spessore / thickness 12 mm

848 - RT59 (Ø 60 cm)	844 - ST59 (60 x 60 cm)
849 - RT69 (Ø 70 cm)	845 - ST69 (70 x 70 cm)
850 - RT79 (Ø 80 cm)	846 - ST79 (80 x 80 cm)
483 - RT90 (Ø 90 cm)	482 - ST90 (90 x 90 cm)
484 - RT120 (Ø 120 cm)	847 - ST119 (120 x 80 cm)
	294 - ST180 (180 x 90 cm)

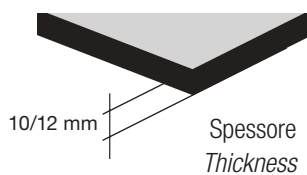

Bordo (B)
Edge (B)



Bordo (WH)
Edge (WH)



Bordo (ZA)
Edge (ZA)



TUTTI I PIANI IN HPL POSSONO ESSERE PERSONALIZZATI
ALL HPL TOPS CAN BE CUSTOMIZED

PIANI E BASI CORRELATI IN HPL COMPACT
RELATED TOPS AND BASES IN HPL COMPACT

BASI IN HPL COMPACT / HPL COMPACT BASES

Basi in stratificato HPL COMPACT, spessore 20 mm, tubo in metallo, piastra superiore (300 x 300 x 3 mm) piedini regolabili
HPL compact table bases, tikness 20 mm, metal column, top plate (300 x 300 x 3 mm), adjustable feet

Base quadrata, tubo 80x80 mm
Square base, column 80x80 mm

Colonna nero/bianco - *Column black/white*

225-HPQ 403 (400 x 400 x 20 x H 733 mm) kg 10
 271-HPQ 405 (400 x 400 x 20 x H 1110 mm) kg 12
 269-HPQ 501 (500 x 500 x 20 x H 733 mm) kg 13

Colonna in acciaio inox satinato
Satin stainless steel column

226-HPQ 404 (400 x 400 x 20 x H 733 mm) kg 10
 274-HPQ 406 (400 x 400 x 20 x H 1110 mm) kg 12
 270-HPQ 502 (500 x 500 x 20 x H 733 mm) kg 13

Colonna ottonata - *Golden effect column*

218-HPQ 408 (400 x 400 x 20 x H 733 mm) kg 10
 220-HPQ 409 (400 x 400 x 20 x H 1110 mm) kg 12
 222-HPQ 410 (500 x 500 x 20 x H 733 mm) kg 13

Base rotonda, tubo Ø 76 mm
Round base, column Ø 76 mm

Colonna nero/bianco - *Column black/white*

227-HPR 403 (Ø 400 x 20 x H 733 mm) kg 7,5
 275-HPR 405 (Ø 400 x 20 x H 1110 mm) kg 9,5
 264-HPR 501 (Ø 500 x 20 x H 733 mm) kg 10,5

Colonna in acciaio inox satinato
Satin stainless steel column

228-HPR 404 (Ø 400 x 20 x H 733 mm) kg 7,5
 278-HPR 406 (Ø 400 x 20 x H 1110 mm) kg 9,5
 265-HPR 502 (Ø 500 x 20 x H 733 mm) kg 10,5

Colonna ottonata - *Golden effect column*

329-HPR 408 (Ø 400 x 20 x H 733 mm) kg 7,5
 330-HPR 409 (Ø 400 x 20 x H 1110 mm) kg 9,5
 331-HPR 410 (Ø 500 x 20 x H 733 mm) kg 10,5



HPL COMPACT "KARARA WHITE"



HPL COMPACT "KARARA WHITE"



HPL COMPACT "KARARA WHITE"



HPL COMPACT "BROOKLIN LIGHT"



HPL COMPACT "BROOKLIN LIGHT"



HPL COMPACT "BROOKLIN LIGHT"



HPL COMPACT "BROOKLYN DARK"



HPL COMPACT "BROOKLYN DARK"



HPL COMPACT "OLD PAINT"



HPL COMPACT "URBAN TEAK"



HPL COMPACT "CANYON MONUMENT OAK"



HPL COMPACT "BLUE WOOD"



HPL COMPACT "COPPER PAINTED"

PIANI PER ESTERNO "WERZALIT"
OUTDOOR TOPS "WERZALIT"



RUSTBROWN



KBANA ROUGE



KBANA TAUPE



KANSAS



ARIZONA



634 - R060 (Ø 60 cm)
 635 - R070 (Ø 70 cm)
 636 - R080 (Ø 80 cm)

630 - SQ60 (60 x 60 cm)
 631 - SQ70 (70 x 70 cm)
 632 - SQ80 (80 x 80 cm)
 633 - SQ120 (120 x 80 cm)

PIANI PER ESTERNO "WERZALIT"
 OUTDOOR TOPS "WERZALIT"



OAK ANTIC



ANTRACITE



WENGHE



FINDUS GREY



MONTPELLIER



634 - R060 (Ø 60 cm)
 635 - R070 (Ø 70 cm)
 636 - R080 (Ø 80 cm)

630 - SQ60 (60 x 60 cm)
 631 - SQ70 (70 x 70 cm)
 632 - SQ80 (80 x 80 cm)
 633 - SQ120 (120 x 80 cm)

PIANI PER ESTERNO "WERZALIT"
OUTDOOR TOPS "WERZALIT"



ALU



TRAVERTIN



MARBLE ALMERIA



MARBLE MARQUINA



PAUSSADE GRIS



634 - R060 (Ø 60 cm)
 635 - R070 (Ø 70 cm)
 636 - R080 (Ø 80 cm)

630 - SQ60 (60 x 60 cm)
 631 - SQ70 (70 x 70 cm)
 632 - SQ80 (80 x 80 cm)
 633 - SQ120 (120 x 80 cm)

PIANI PER ESTERNO "WERZALIT"
OUTDOOR TOPS "WERZALIT"



BLANC

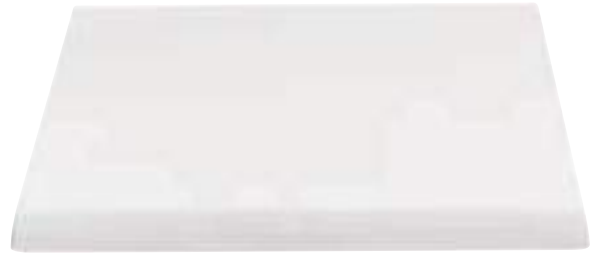

NOIRE



PIANI IN ACCIAIO
STAINLESS STEEL TOPS



187 - MAR1 (Ø 60 cm)
 188 - MAR2 (Ø 70 cm)
 189 - MAR3 (Ø 80 cm)



190 - MAS1 (60 x 60cm)
 191 - MAS2 (70 x 70cm)
 192 - MAS3 (80 x 80cm)
 776 - MAS7 (120 x 80cm)

PIANI IN DOGHE DI LEGNO BORDATI IN ALLUMINIO
WOOD BAND TOPS, ALUMINUM EDGE



196 - MLR1 (Ø 60 cm)
 197 - MLR2 (Ø 70 cm)
 198 - MLR3 (Ø 80 cm)



199 - MLS1 (60 x 60 cm)
 200 - MLS2 (70 x 70 cm)
 201 - MLS3 (80 x 80 cm)
 203 - MLS5 (120 x 70 cm)

PIANI IN TEAK / TEAK TOPS



- 1219 - TGF260A (60 x 60 x 2,7 cm)
- 1220 - TGF260B (70 x 70 x 2,7 cm)
- 1221 - TGF260C (80 x 80 x 2,7 cm)
- 1223 - TGF257B (120 x 80 x 2,7 cm)



- 1216 - TGF258A (Ø 60 x 2,7 cm)
- 1217 - TGF258B (Ø 70 x 2,7 cm)
- 1218 - TGF258C (Ø 80 x 2,7 cm)



BASE - BASE
611 - F3 - pg. 360

PIANI IN TEAK / TEAK TOPS



696 - TKS60 (60 x 60)
 701 - TKS70 (70 x 70)
 703 - TKS80 (80 x 80)
 704 - TKS120 (120 x 80)



707 - TKR60 (Ø 60)
 708 - TKR70 (Ø 70)
 709 - TKR80 (Ø 80)



BASE - *BASE*
 185 - F4 - *pg. 362*

PIANI DA INTERNO EXTRA
INDOOR TOPS EXTRA



PIANO LAMINATO BORDO ABS OTTONATO SPESSORE 30 mm

002 - SFB01	(60 x 60 cm)
003 - SFB02	(70 x 70 cm)
008 - SFB03	(80 x 80 cm)
009 - RFB04	(Ø 60 cm)
014 - RFB05	(Ø 70 cm)
017 - RFB06	(Ø 80 cm)



PIANO COMPLETO DI VETRO, RETROLACCATO AL COLORE
RICHIESTO SPESSORE 30 mm

018 - SFB07	(60 x 60 cm)
019 - SFB08	(70 x 70 cm)
021 - SFB09	(80 x 80 cm)
022 - RFB10	(Ø 60 cm)
023 - RFB11	(Ø 70 cm)
027 - RFB12	(Ø 80 cm)



PIANO IN LAMELLARE DI ABETE STAMPATO SPESSORE 40 mm

028 - SFB13	(60 x 60 cm)
029 - SFB14	(70 x 70 cm)
030 - SFB15	(80 x 80 cm)



PIANO ROVERE TINTO BORDO CORTECCIA SPESSORE 40 mm

032 - SFB16	(60 x 60 cm)
033 - SFB17	(70 x 70 cm)
034 - SFB18	(80 x 80 cm)



PIANO IN LAMINATO EFFETTO PIASTRELLA BORDO IN LEGNO
SPESSORE 20 mm

036 - SFB19	(60 x 60 cm)
044 - SFB20	(70 x 70 cm)
045 - SFB21	(80 x 80 cm)

PIANI IN LAMINATO / LAMINATE TOPS



ROVERE SBIANCATO FA1014



FA3849



ROVERE 7 NODI FA3755



FA4767

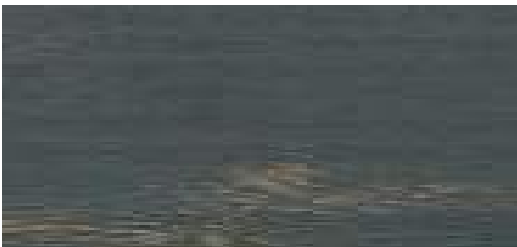

ROVERE TINTO GRIGIO SCURO FA6544



FA5849



ROVERE TINTO GRIGIO MEDIO FA7144



FA2047

PIANI IN LAMINATO / LAMINATE TOPS



MARMO LUCIDO BIANCO FA0643

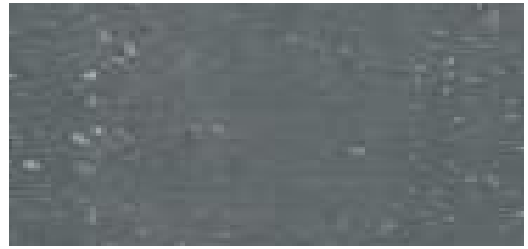

ROX BLACK

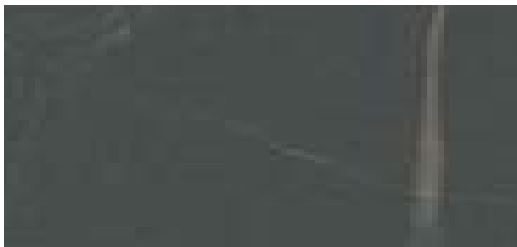

MARMO ELITE



NOCE FA0825



PULPIS LIGHT



ROVERE NATURALE FA1001



CUMA LIGHT



CORTEN FA8934

PIANI IN LAMINATO / LAMINATE TOPS



MARMO LUCIDO NERO FA6743

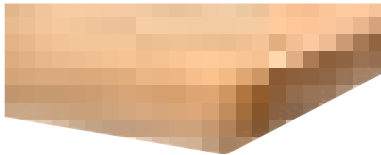

CEMENTO FA7044

BORDO ABS IN TINTA
ABS EDGE

BORDO IN GOMMA
RUBBER EDGE

SPESSORE 24mm / THICKNESS 24mm

1356 - ST60 (60 x 60 cm)	1360 - RT60 (Ø 60 cm)
1357 - ST70 (70 x 70 cm)	1361 - RT70 (Ø 70 cm)
1358 - ST80 (80 x 80 cm)	1362 - RT80 (Ø 80 cm)
1359 - ST120 (120 x 80 cm)	

SPESSORE 24mm / THICKNESS 24mm

1384 - STG60 (60 x 60 cm)	1388 - RTG60 (Ø 60 cm)
1385 - STG70 (70 x 70 cm)	1389 - RTG70 (Ø 70 cm)
1386 - STG80 (80 x 80 cm)	1390 - RTG80 (Ø 80 cm)
1387 - STG120 (120 x 80 cm)	

SPESSORE 30mm / THICKNESS 30mm

1363 - ST63 (60 x 60 cm)	1367 - RT63 (Ø 60 cm)
1364 - ST73 (70 x 70 cm)	1368 - RT73 (Ø 70 cm)
1365 - ST83 (80 x 80 cm)	1369 - RT83 (Ø 80 cm)
1366 - ST123 (120 x 80 cm)	

SPESSORE 27mm / THICKNESS 27mm

1391 - STG62 (60 x 60 cm)	1395 - RTG62 (Ø 60 cm)
1392 - STG72 (70 x 70 cm)	1396 - RTG72 (Ø 70 cm)
1393 - STG82 (80 x 80 cm)	1397 - RTG82 (Ø 80 cm)
1394 - STG122 (120 x 80 cm)	

SPESSORE 40mm / THICKNESS 40mm

1370 - ST64 (60 x 60 cm)	1374 - RT64 (Ø 60 cm)
1371 - ST74 (70 x 70 cm)	1375 - RT74 (Ø 70 cm)
1372 - ST84 (80 x 80 cm)	1376 - RT84 (Ø 80 cm)
1373 - ST124 (120 x 80 cm)	

SPESSORE 30mm / THICKNESS 30mm

1398 - STG63 (60 x 60 cm)	1402 - RTG63 (Ø 60 cm)
1399 - STG73 (70 x 70 cm)	1403 - RTG73 (Ø 70 cm)
1400 - STG83 (80 x 80 cm)	1404 - RTG83 (Ø 80 cm)
1401 - STG123 (120 x 80 cm)	

SPESSORE 50mm / THICKNESS 50mm

1377 - ST65 (60 x 60 cm)	1381 - RT65 (Ø 60 cm)
1378 - ST75 (70 x 70 cm)	1382 - RT75 (Ø 70 cm)
1379 - ST85 (80 x 80 cm)	1383 - RT85 (Ø 80 cm)
1380 - ST125 (120 x 80 cm)	

**TUTTI I PIANI IN LAMINATO POSSONO ESSERE
PERSONALIZZATI NEI COLORI E NELLE MISURE**
**ALL LAMINATE TOPS CAN BE CUSTOMIZED
IN COLORS AND SIZES**



**Basi & piani
per tavoli**

***Table bases
& tops***